

## Data Sheet | Item Number: 2050-313

2-conductor miniature through terminal block; with operating slots; 1 mm<sup>2</sup>; with snap-in mounting foot; side and center marking; with test port; Push-in CAGE CLAMP®; 1,00 mm<sup>2</sup>; red

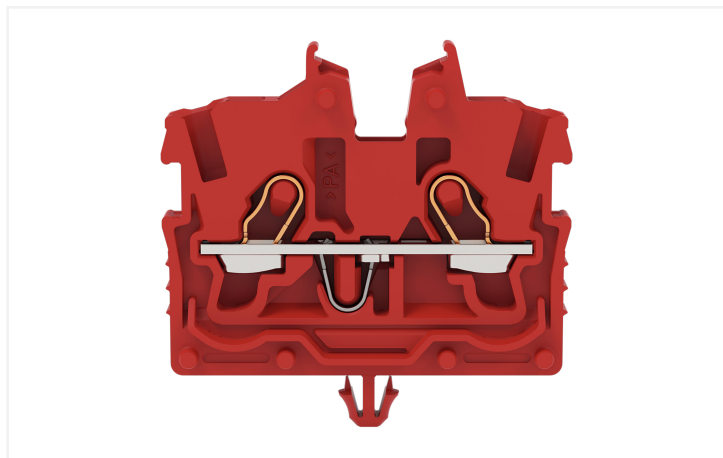

<https://www.wago.com/2050-313>



Color: ■ red

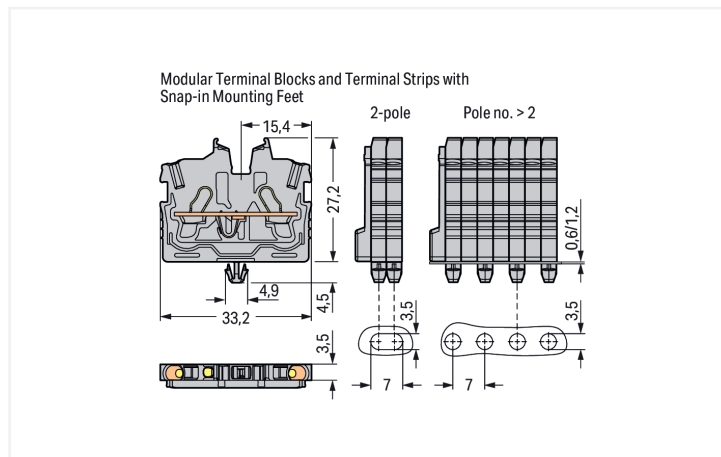
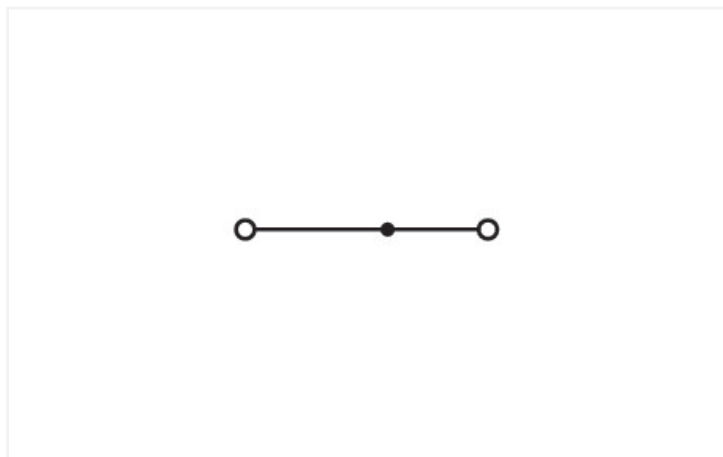

Similar to illustration

### Through terminal block, 2050 Series, operating tool

Our through terminal block (item number 2050-313) ensures effortless electrical installations. Ensure that the strip lengths are between 9 and 11 mm when connecting conductors to this through terminal block. Whether in industrial or building applications, our rail-mount through terminal blocks are the perfect solution to quickly and securely connect electrical conductors. Depending on the model, you can use them for either typical through-wiring or potential distribution. This product features conductor terminals and utilizes Push-in CAGE CLAMP®. Push-in CAGE CLAMP® connection technology is ideal for connecting all conductor types. It allows direct insertion of both solid and fine-stranded conductors with ferrules without needing to use any tools—all thanks to its pluggable design. Depending on the type of conductor, this through terminal block is suitable for conductor cross sections ranging from 0.14 mm<sup>2</sup> to 1.5 mm<sup>2</sup>.

This mini rail-mount terminal block is operated with an operating tool. Our TOPJOB® S rail-mount terminal blocks offer more than just secure electrical connections in different industrial applications and modern building installations. They also offer the perfect actuation option for every need: lever, push-button, or operating slot. This product is designed for specific Ex applications (please refer to the product datasheet).

## Electrical data

Ratings per	IEC/EN 60998-2-2		
Overvoltage category	III	III	II
Pollution degree	3	2	2
Nominal voltage	500 V	-	-
Rated impulse withstand voltage	6 kV	-	-
Rated current	13.5 A	-	-
Current at conductor cross-section (max.) mm <sup>2</sup>	17.5 A	-	-

Approvals per	UL 1059		
Use group	B	C	D
Rated voltage	300 V	300 V	-
Rated current	10 A	10 A	-

Approvals per	CSA 22.2 No 158		
Use group	B	C	D
Rated voltage	300 V	300 V	-
Rated current	10 A	10 A	-

Ex information	
Reference to hazardous areas	See "Downloads – Documentation – Additional Information: Technical Section; Technical Explanations"
Ratings per	ATEX: PTB 19 ATEX 1019 U / IECEx: PTB 19.0050U (Ex eb IIC Gb)
Rated voltage EN (Ex e II)	352 V
Rated current (Ex e II)	13.5 A
Rated current (Ex e II) with jumper	12 A

## Power Loss

Power loss, per pole (potential)	0.4338 W
Rated current $I_N$ for power loss specification	13.5 A
Resistance value for specified, current-dependent power loss	0.00238 $\Omega$

## General information

Wiring direction	Front-entry wiring
------------------	--------------------

## Connection Data

Clamping units	2
Total number of potentials	1
Number of levels	1
Number of jumper slots	1

Connection 1	
Connection technology	Push-in CAGE CLAMP®
Actuation type	Operating tool
Connectable conductor materials	Copper
Nominal cross-section	1 mm <sup>2</sup>
Solid conductor	0.14 ... 1.5 mm <sup>2</sup> / 24 ... 16 AWG
Solid conductor; push-in termination	0.5 ... 1.5 mm <sup>2</sup> / 20 ... 16 AWG
Fine-stranded conductor	0.14 ... 1.5 mm <sup>2</sup> / 24 ... 16 AWG
Fine-stranded conductor; with insulated ferrule	0.14 ... 1 mm <sup>2</sup> / 24 ... 18 AWG
Fine-stranded conductor; with uninsulated ferrule	0.14 ... 1 mm <sup>2</sup> / 24 ... 18 AWG
Fine-stranded conductor; with ferrule; push-in termination	0.5 ... 1 mm <sup>2</sup> / 20 ... 18 AWG
Note (conductor cross-section)	Depending on the conductor characteristic, a conductor with a smaller cross-section can also be inserted via push-in termination.
Strip length	9 ... 11 mm / 0.35 ... 0.43 inches
Wiring direction	Front-entry wiring

### Physical data

Width	3.5 mm / 0.138 inches
Height from the surface	27.2 mm / 1.071 inches
Depth	33.2 mm / 1.307 inches

### Mechanical data

Mounting type	Snap-in foot
Marking level	Center/side marking

### Material data

Note (material data)	<a href="#">Information on material specifications can be found here</a>
Color	red
Material group	I
Insulation material (main housing)	Polyamide (PA66)
Flammability class per UL94	V0
Fire load	0.042 MJ
Weight	2.4 g

### Environmental requirements

Processing temperature	-35 ... +85 °C
Continuous operating temperature	-60 ... +105 °C

### Commercial data

PU (SPU)	100 pcs
Packaging type	Box
Country of origin	IN
GTIN	4066966312683
Customs tariff number	85369010000

### Product Classification

UNSPSC	39121410
ETIM 9.0	EC001284
ETIM 10.0	EC001284
ECCN	NO US CLASSIFICATION

### Environmental Product Compliance

RoHS Compliance Status	Compliant, No Exemption
------------------------	-------------------------

### Approvals / Certificates

#### Approvals for marine applications



Approval	Standard	Certificate Name
DNV DNV GL SE	-	TAE00003JT

#### Approvals for hazardous areas



Approval	Standard	Certificate Name
ATEX Physikalisch Technische Bundesanstalt	EN 60079	PTB 19 ATEX 1019 U
CCC CNEX	GB/T 3836.3	2020312313000289 (Ex eb IIC Gb, Ex eb I Mb)

## Approvals for hazardous areas

IECEX Physikalisch Technische Bundesanstalt	IEC 60079	IECEX PTB 19.0050U
INMETRO TÜV Rheinland do Brasil Lt- da.	IEC 60079	TÜV 22.0014 U

## Downloads

### Environmental Product Compliance

#### Compliance Search

Environmental Product  
Compliance 2050-313



## CAD/CAE-Data

### CAD data

2D/3D Models 2050-313



## 1 Compatible Products

### 1.1 System counterpart

#### 1.1.1 Through terminal block



##### Item No.: 2050-321

2-conductor miniature through terminal block; with operating slots; 1 mm<sup>2</sup>; Center terminal block without snap-in mounting foot, without mounting flange; side and center marking; with test port; Push-in CAGE CLAMP®; 1,00 mm<sup>2</sup>; gray

### 1.2 Required Accessories

#### 1.2.1 End plate

##### 1.2.1.1 End plate



##### Item No.: 2050-391

End plate; for terminal blocks with snap-in mounting foot; 3.4 mm thick; gray

### 1.3 Optional Accessories

#### 1.3.1 DIN-rail

##### 1.3.1.1 Mounting accessories



**Item No.: 210-154**

Aluminum carrier rail; 1000 mm long; 18 mm wide; 7 mm high; silver-colored

#### 1.3.2 Ferrule

##### 1.3.2.1 Ferrule



**Item No.: 216-241**

Ferrule; Sleeve for 0.5 mm<sup>2</sup> / 20 AWG; insulated; electro-tin plated; electrolytic copper; gastight crimped; acc. to DIN 46228, Part 4/09.90; white



**Item No.: 216-242**

Ferrule; Sleeve for 0.75 mm<sup>2</sup> / 18 AWG; insulated; electro-tin plated; electrolytic copper; gastight crimped; acc. to DIN 46228, Part 4/09.90; gray



**Item No.: 216-243**

Ferrule; Sleeve for 1 mm<sup>2</sup> / AWG 18; insulated; electro-tin plated; electrolytic copper; gastight crimped; acc. to DIN 46228, Part 4/09.90; red

#### 1.3.3 Installation

##### 1.3.3.1 Mounting accessories



**Item No.: 209-137**

Mounting adapter; can be used as end stop; 6.5 mm wide; gray



**Item No.: 209-120**

Mounting foot; can be snapped on terminal blocks with snap-in mounting foot; for mounting on relay-modules; 6.4 mm wide; gray

#### 1.3.4 Jumper

##### 1.3.4.1 Jumper



**Item No.: 2000-406/020-000**

Delta jumper; insulated; light gray



**Item No.: 2000-410/000-006**

Jumper; 10-way; insulated; blue



**Item No.: 2000-410**

Jumper; 10-way; insulated; light gray



**Item No.: 2000-410/000-005**

Jumper; 10-way; insulated; red



**Item No.: 2000-402/000-006**

Jumper; 2-way; insulated; blue



**Item No.: 2000-402**

Jumper; 2-way; insulated; light gray



**Item No.: 2000-402/000-005**

Jumper; 2-way; insulated; red



**Item No.: 2000-402/000-018**

Jumper; 2-way; insulated; yellow-green



**Item No.: 2000-403/000-006**

Jumper; 3-way; insulated; blue



**Item No.: 2000-403**

Jumper; 3-way; insulated; light gray



**Item No.: 2000-403/000-005**

Jumper; 3-way; insulated; red



**Item No.: 2000-404/000-006**

Jumper; 4-way; insulated; blue



**Item No.: 2000-404**

Jumper; 4-way; insulated; light gray



**Item No.: 2000-404/000-005**

Jumper; 4-way; insulated; red



**Item No.: 2000-405/000-006**

Jumper; 5-way; insulated; blue



**Item No.: 2000-405**

Jumper; 5-way; insulated; light gray



**Item No.: 2000-405/000-005**

Jumper; 5-way; insulated; red



**Item No.: 2000-406/000-006**

Jumper; 6-way; insulated; blue



**Item No.: 2000-406**

Jumper; 6-way; insulated; light gray



**Item No.: 2000-406/000-005**

Jumper; 6-way; insulated; red

1.3.4.1 Jumper



**Item No.: 2000-407/000-006**  
Jumper; 7-way; insulated; blue



**Item No.: 2000-407**  
Jumper; 7-way; insulated; light gray



**Item No.: 2000-407/000-005**  
Jumper; 7-way; insulated; red



**Item No.: 2000-408/000-006**  
Jumper; 8-way; insulated; blue



**Item No.: 2000-408**  
Jumper; 8-way; insulated; light gray



**Item No.: 2000-408/000-005**  
Jumper; 8-way; insulated; red



**Item No.: 2000-409/000-006**  
Jumper; 9-way; insulated; blue



**Item No.: 2000-409**  
Jumper; 9-way; insulated; light gray



**Item No.: 2000-409/000-005**  
Jumper; 9-way; insulated; red



**Item No.: 2000-440**  
Jumper; from 1 to 10; insulated; light gray



**Item No.: 2000-433/000-006**  
Jumper; from 1 to 3; insulated; blue



**Item No.: 2000-433**  
Jumper; from 1 to 3; insulated; light gray



**Item No.: 2000-433/000-005**  
Jumper; from 1 to 3; insulated; red



**Item No.: 2000-434**  
Jumper; from 1 to 4; insulated; light gray



**Item No.: 2000-435**  
Jumper; from 1 to 5; insulated; light gray



**Item No.: 2000-436**  
Jumper; from 1 to 6; insulated; light gray



**Item No.: 2000-437**  
Jumper; from 1 to 7; insulated; light gray



**Item No.: 2000-438**  
Jumper; from 1 to 8; insulated; light gray



**Item No.: 2000-439**  
Jumper; from 1 to 9; insulated; light gray



**Item No.: 2000-405/011-000**  
Star point jumper; 3-way; insulated; light gray

1.3.5 Marking

1.3.5.1 Group marker carrier



**Item No.: 2009-191**  
Group marker carrier; gray

1.3.5.2 Marker



**Item No.: 793-3501**  
WMB marking card; as card; plain; snap-on type; white



**Item No.: 2009-113/000-006**  
WMB-Inline; for Smart Printer; 2300 pieces on roll; plain; snap-on type; blue



**Item No.: 2009-113/000-007**  
WMB-Inline; for Smart Printer; 2300 pieces on roll; plain; snap-on type; gray



**Item No.: 2009-113/000-023**  
WMB-Inline; for Smart Printer; 2300 pieces on roll; plain; snap-on type; green



**Item No.: 2009-113/000-017**  
WMB-Inline; for Smart Printer; 2300 pieces on roll; plain; snap-on type; light green



**Item No.: 2009-113/000-012**  
WMB-Inline; for Smart Printer; 2300 pieces on roll; plain; snap-on type; orange



**Item No.: 2009-113/000-005**  
WMB-Inline; for Smart Printer; 2300 pieces on roll; plain; snap-on type; red



**Item No.: 2009-113/000-024**  
WMB-Inline; for Smart Printer; 2300 pieces on roll; plain; snap-on type; violet



**Item No.: 2009-113**  
WMB-Inline; for Smart Printer; 2300 pieces on roll; plain; snap-on type; white



**Item No.: 2009-113/000-002**  
WMB-Inline; for Smart Printer; 2300 pieces on roll; plain; snap-on type; yellow

1.3.5.3 Marking strip



**Item No.: 2009-110**  
Marking strips; for Smart Printer; on reel; not stretchable; plain; snap-on type; white

### 1.3.6 Protective warning marker

#### 1.3.6.1 Cover



**Item No.: 2000-115**

Protective warning marker; for 5 terminal blocks; with high-voltage symbol, black; yellow

### 1.3.7 Push-in type wire jumper

#### 1.3.7.1 Jumper



**Item No.: 2009-404**

Push-in type wire jumper; 0.75 mm<sup>2</sup>; insulated; 110 mm long; gray



**Item No.: 2009-406**

Push-in type wire jumper; 0.75 mm<sup>2</sup>; insulated; 250 mm long; gray



**Item No.: 2009-402**

Push-in type wire jumper; 0.75 mm<sup>2</sup>; insulated; 60 mm long; gray

### 1.3.8 Test and measurement

#### 1.3.8.1 Testing accessories



**Item No.: 2009-174**

Test plug adapter; for 4 mm Ø test plugs; for testing TOPJOB®S rail-mounted terminal blocks; gray



**Item No.: 210-136**

Test plug; 2 mm Ø; with 500 mm cable; red



**Item No.: 2009-182**

Testing tap; for max. 2.5 mm<sup>2</sup>; tool-free connection for individual test wires 0.08 - 2.5 mm; gray

### 1.3.9 Tool

#### 1.3.9.1 Operating tool



**Item No.: 210-719**

Operating tool; Blade: 2.5 x 0.4 mm; with a partially insulated shaft



**Item No.: 210-648**

Operating tool; Blade: 2.5 x 0.4 mm; with a partially insulated shaft; angled; short



**Item No.: 210-647**

Operating tool; Blade: 2.5 x 0.4 mm; with a partially insulated shaft; multicoloured

## Installation Notes

### Installation

Example of a 5-pole terminal strip, with operating slot, with snap-in mounting feet  
Page number: 2

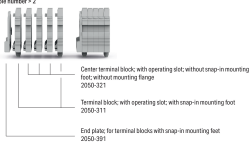

Example of a 2-pole terminal strip, with operating slot, with snap-in mounting feet

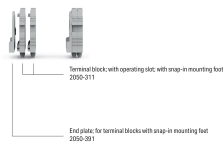

### Conductor termination



Insert solid conductors via push-in termination.



Insert ferruled conductors via push-in termination.



Insert fine-stranded conductors via operating tool.

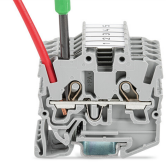

Remove all conductors via operating tool.

### Commoning

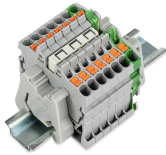

Insert a delta jumper and push down until it hits the backstop (example shows terminal blocks with push-buttons).

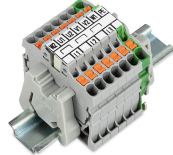

Marking strip (Item No. 2009-110) inserted in the marking slot with jumper symbols of the inserted jumper (delta jumper) (example shows terminal blocks with push-buttons)



Insert a star point jumper and push down until it hits the backstop (example shows terminal blocks with push-buttons).

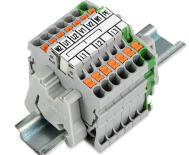

Marking strip (Item No. 2009-110) inserted in the marking slot with jumper symbols of the inserted jumper (2000-405/011-000 Delta Jumper) (example shows terminal blocks with push-buttons)

### Testing



Testing with a 2 mm Ø 210-136 Test Plug (max. 42 V).

### Installation



Mounting a terminal strip with snap-in feet into holes.



Mounting a terminal strip with snap-in feet onto aluminum rail.

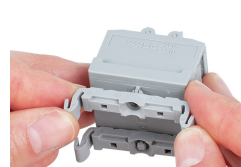

Snapping a mounting foot (209-120) to a terminal strip with snap-in mounting feet.  
(Distance between mounting feet: approx. 20 ... 25 mm)

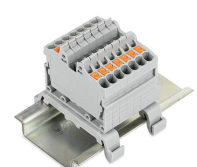

Terminal strip; with snap-in mounting feet; for DIN-35 rail (209-120 Mounting Foot) (example shows terminal blocks with push-buttons)

### Marking



Snapping a marking strip into the marker slot.



Snapping a marking strip (Item No. 2009-110) into a marker slot.