

CIRH03T2821SCNF80M32V0 × OBSOLETE

TE Internal #: Y5015-000000100142

TE Internal Description: FIXED SOCKET CONNECTOR

[View on TE.com >](#)



Connectors > Circular Connectors > Standard Circular Connectors



Number of Positions: 37

Connector System: **Cable-to-Cable, Wire-to-Wire**

Connector & Contact Terminates To: **Wire & Cable**

Circuit Application: **Power & Signal**

Connector Mounting Type: **Panel Mount**

Features

Usage Conditions

IP Water Sealing Level	IP67
------------------------	------

Packaging Features

Packaging Quantity	10
--------------------	----

Other

Field Serviceable	Yes
-------------------	-----

Position Locations Omitted	All
----------------------------	-----

EU RoHS Compliance	Compliant with Exemptions
--------------------	---------------------------

EU ELV Compliance	Compliant with Exemptions
-------------------	---------------------------

Body Features

Primary Product Color	Black
-----------------------	-------

Shell Plating Material	Black Chromate Over Zn Cobalt
------------------------	-------------------------------

Shell Base Material	Aluminum Alloy
---------------------	----------------

Circular Connector Insulation Material Type	Low Fire Hazard Rubber
---	------------------------

Mechanical Attachment

Panel Mount Feature Type	Square Flange
--------------------------	---------------

Mating Retention Type	Bayonet
-----------------------	---------

Mating Alignment	With
------------------	------

Connector Mounting Type	Panel Mount
-------------------------	-------------

Mating Alignment Type	Keyed
-----------------------	-------

Mating Retention

With

Product Type Features

Prewired

No

Connector Product Type

Connector Assembly

Connector System

Cable-to-Cable, Wire-to-Wire

Connector & Contact Terminates To

Wire & Cable

Circular Connector Type

Receptacle

Shell Type

Metal

Configuration Features

Factory Installed Backshell

Without

Number of Positions

37

Contacts Preloaded

No

Contact Features

Reverse Gender

Yes

Contact Layout Arrangement

28 – 21

Circular Connector Contact Type

Socket

Housing Features

Circular Connector Shell Size

28

Operation/Application

Circuit Application

Power & Signal

Shielded

Yes

Product Compliance

For compliance documentation, visit the product page on [TE.com](#)>

EU RoHS Directive 2011/65/EU

Compliant with Exemptions

EU ELV Directive 2000/53/EC

Compliant with Exemptions

China RoHS 2 Directive MIIT Order No 32, 2016

Restricted Materials Above Threshold

EU REACH Regulation (EC) No. 1907/2006

Current ECHA Candidate List: JUNE 2024
(241)Candidate List Declared Against: JAN 2021
(211)

SVHC > Threshold:

Pb (.15% in Aluminium alloy component)

Article Safe Usage Statements:

Do not eat, drink or smoke when using this product. Wash thoroughly after handling. Recycle if possible and dispose of the article by following all applicable governmental regulations relevant to your geographic location.

Halogen Content

Not Yet Reviewed for halogen content

Solder Process Capability

Not applicable for solder process capability

Product Compliance Disclaimer

This information is provided based on reasonable inquiry of our suppliers and represents our current actual knowledge based on the information they provided. This information is subject to change. The part numbers that TE has identified as EU RoHS compliant have a maximum concentration of 0.1% by weight in homogenous materials for lead, hexavalent chromium, mercury, PBB, PBDE, DBP, BBP, DEHP, DIBP, and 0.01% for cadmium, or qualify for an exemption to these limits as defined in the Annexes of Directive 2011/65/EU (RoHS2). Finished electrical and electronic equipment products will be CE marked as required by Directive 2011/65/EU. Components may not be CE marked. Additionally, the part numbers that TE has identified as EU ELV compliant have a maximum concentration of 0.1% by weight in homogenous materials for lead, hexavalent chromium, and mercury, and 0.01% for cadmium, or qualify for an exemption to these limits as defined in the Annexes of Directive 2000/53/EC (ELV). Regarding the REACH Regulation, the information TE provides on SVHC in articles for this part number is based on the latest European Chemicals Agency (ECHA) 'Guidance on requirements for substances in articles' posted at this URL: <https://echa.europa.eu/guidance-documents/guidance-on-reach>

Customers Also Bought

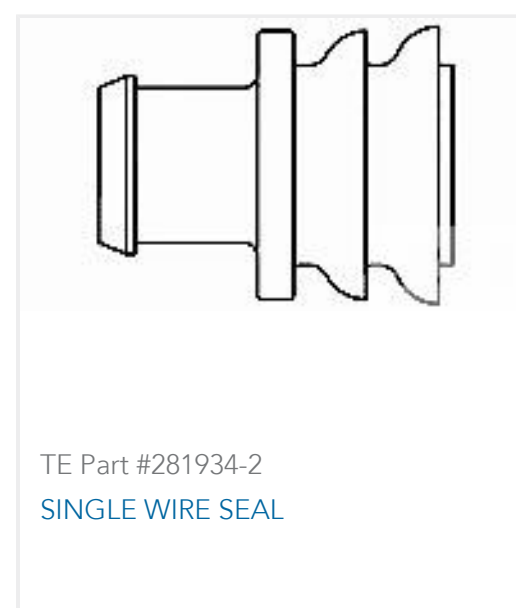

Documents

Product Drawings

FIXED SOCKET CONNECTOR

French

Datasheets & Catalog Pages

CIRH Brochure

English

Product Specifications

Application Specification

French

