

SRK06-MDI-32A-001 ✓ ACTIVE

DEUTSCH | STRIKE

TE Internal #: SRK06-MDI-32A-001

32 Position Housing, Housing for Female Terminals, Wire-to-Wire, 3.4 mm [.134 in] Centerline, Sealable, Black, Wire & Cable, Power

[View on TE.com >](#)



Connectors > Automotive Connectors > Automotive Housings > DEUTSCH Strike Housings

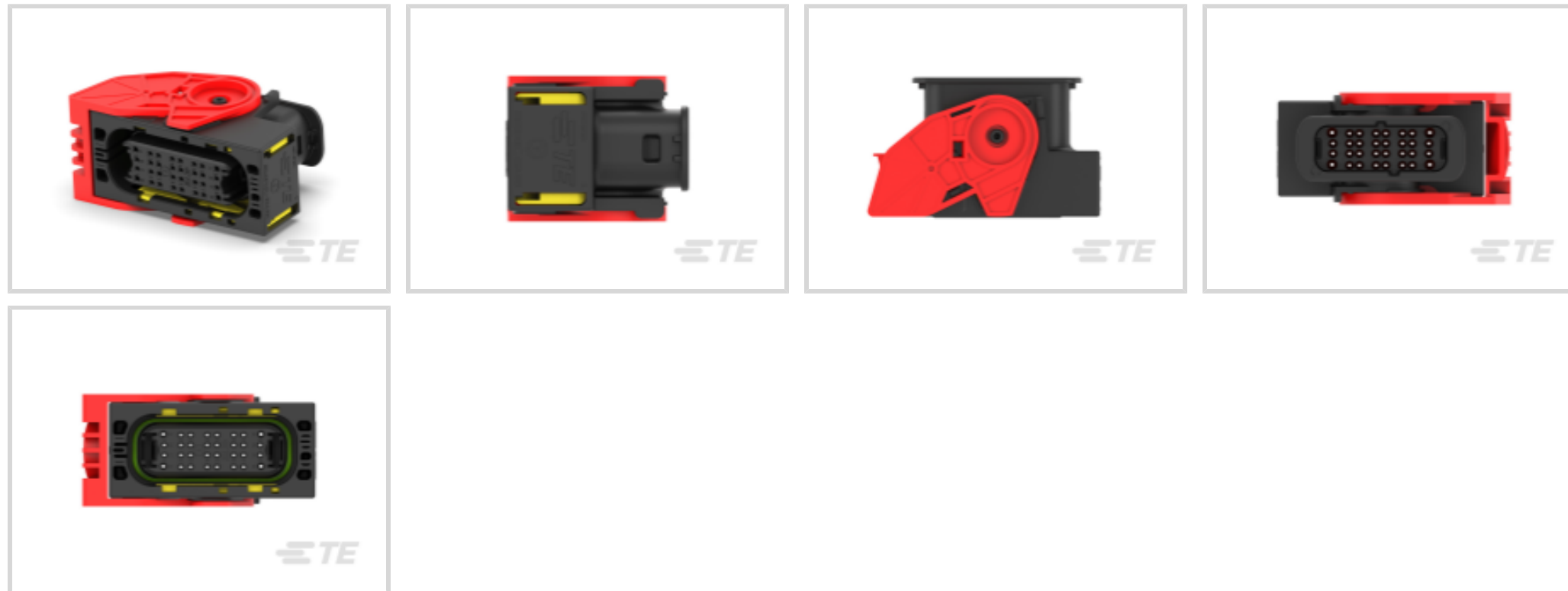

Number of Positions: 32

Connector & Housing Type: **Housing for Female Terminals**

Mating Pin Diameter: 1 mm, 1.55 mm [.039 in, .061 in]

Connector System: **Wire-to-Wire**

Centerline (Pitch): 3.4 mm [.134 in]

[All DEUTSCH Strike Housings \(20\)](#)

Features

Industry Standards

IP Rating	IP6K9K, IP68
Compatible With Agency/Standards Products	SAE J2030
UL Flammability Rating	Not tested

Dimensions

Row-to-Row Spacing	3.5 mm, 11.35 mm, 10.85 mm[.138 in][.427 in][.447 in]
Compatible Insulation Diameter Range	1.55 – 2.41 mm, 1.55 – 3.05 mm[.061 – .12 in][.061 – .095 in]
Product Width	38.9 mm[1.532 in]
Product Length	81 mm[3.189 in]
Connector Height	48.5 mm[1.909 in]

Packaging Features

Packaging Quantity	144
Packaging Method	Box



Mechanical Attachment

Strain Relief	With
Terminal Position Assurance	Yes
Mating Alignment Type	Keyed
Mating Alignment	With
Connector Mounting Type	Cable Mount (Free-Hanging)

Other

Serviceable	Yes
Connector Position Assurance Capable	No
EU RoHS Compliance	Compliant
EU ELV Compliance	Compliant

Electrical Characteristics

Operating Voltage	48 VDC
Nominal Voltage Architecture	48 V

Body Features

Cable Exit Angle	180°
Primary Product Color	Black
Connector & Keying Code	I

Housing Features

Housing Material	PBT
Centerline (Pitch)	3.4 mm [.134 in]

Contact Features

Contact Size	Size 16, Size 20
Contact Type	Socket
Mating Pin Diameter	1 mm, 1.55 mm [.039 in] [.061 in]
Contact Current Rating (Max)	13 A, 7.5 A

Product Type Features

Mixed & Hybrid Connector	Yes
Connector Shape	Rectangular
Connector & Housing Type	Housing for Female Terminals
Connector System	Wire-to-Wire
Sealable	Yes



Primary Locking Feature	Integrated in Housing
-------------------------	-----------------------

Connector & Contact Terminates To	Wire & Cable
-----------------------------------	--------------

Configuration Features

Number of Positions	32
---------------------	----

Number of Rows	4
----------------	---

Usage Conditions

Operating Temperature (Max)	125 °C[257 °F]
-----------------------------	----------------

Operating Temperature Range	-55 – 125 °C[-67 – 257 °F]
-----------------------------	----------------------------

Operation/Application

Circuit Application	Power
---------------------	-------

Product Compliance

[For compliance documentation, visit the product page on TE.com>](#)

EU RoHS Directive 2011/65/EU	Compliant
------------------------------	-----------

EU ELV Directive 2000/53/EC	Compliant
-----------------------------	-----------

China RoHS 2 Directive MIIT Order No 32, 2016	No Restricted Materials Above Threshold
---	---

EU REACH Regulation (EC) No. 1907/2006	Current ECHA Candidate List: JUNE 2024 (241) Candidate List Declared Against: JAN 2023 (233) Does not contain REACH SVHC
--	--

Halogen Content	Not Yet Reviewed for halogen content
-----------------	--------------------------------------

Solder Process Capability	Not reviewed for solder process capability
---------------------------	--

Product Compliance Disclaimer

This information is provided based on reasonable inquiry of our suppliers and represents our current actual knowledge based on the information they provided. This information is subject to change. The part numbers that TE has identified as EU RoHS compliant have a maximum concentration of 0.1% by weight in homogenous materials for lead, hexavalent chromium, mercury, PBB, PBDE, DBP, BBP, DEHP, DIBP, and 0.01% for cadmium, or qualify for an exemption to these limits as defined in the Annexes of Directive 2011/65/EU (RoHS2). Finished electrical and electronic equipment products will be CE marked as required by Directive 2011/65/EU. Components may not be CE marked. Additionally, the part numbers that TE has identified as EU ELV compliant have a maximum concentration of 0.1% by weight in homogenous materials for lead, hexavalent chromium, and mercury, and 0.01% for cadmium, or qualify for an exemption to these limits as defined in the Annexes of Directive 2000/53/EC (ELV). Regarding the REACH Regulation, the information TE provides on SVHC in articles for this part number is based on the latest European Chemicals Agency (ECHA) 'Guidance on requirements for substances in articles' posted at this URL: <https://echa.europa.eu/guidance-documents/guidance-on-reach>

Compatible Parts



TE Part # 1062-20-0222
SOC, SF, SIZE 20, 16-22, NI/NI



TE Part # SRK-BS-MD-90-002
BKSHL, MED, BLK, RA, NW 22



TE Part # 1062-20-0344
SOC, SF, SIZE 20, 16-22, SLEVELESS, AU /SN



TE Part # 1062-20-0622
SOC, SF, SIZE 20, 14-16, NI/NI



TE Part # SRK-BS-MD-90-001
BKSHL, MED, BLK, RA, NW 17/22



TE Part # 1062-20-0122
SOC, SF, SIZE 20, 16-22, NI/NI

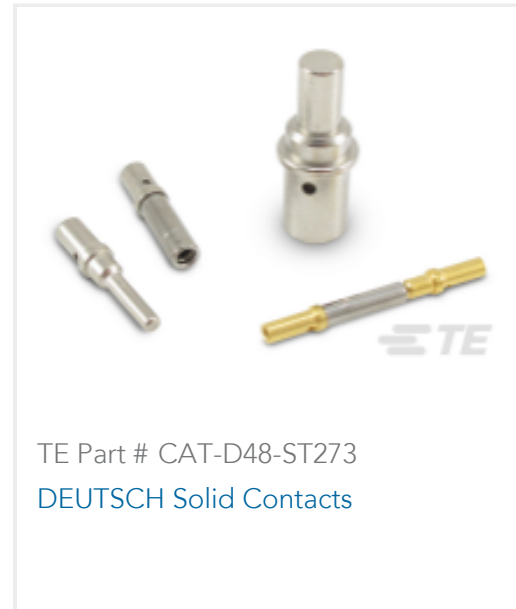

TE Part # CAT-D48-ST273
DEUTSCH Solid Contacts



TE Part # 1062-20-0144
SOC, SF, SIZE 20, 16-22, AU/SN



TE Part # 1062-20-0244
SOC, SF, SIZE 20, 16-22, AU/SN



TE Part # 1062-20-0177
SOC, SF, SIZE 20, 16-22, SN/SN



TE Part # 1062-20-0277
SOC, SF, SIZE 20, 16-22, SN/SN



TE Part # CAT-D48-SP729
DEUTSCH Sealing Plugs



TE Part # SRK02-MDI-32A-001
REC, 32P, BLK, E, FLANGE, I



TE Part # DT-RT1
EXT TOOL, FRONT RELEASE



TE Part # 1062-20-0322
SOC, SF, SIZE 20, 16-22, SLEVELESS, NI /NI



TE Part # SRK-BS-MD-ST-002
BKSHL, MED, BLK, ST, NW 22



TE Part # 1062-20-0677
SOC, SF, SIZE 20, 14-16, SN/SN



TE Part # 1062-20-0644
SOC, SF, SIZE 20, 14-16, AU/SN

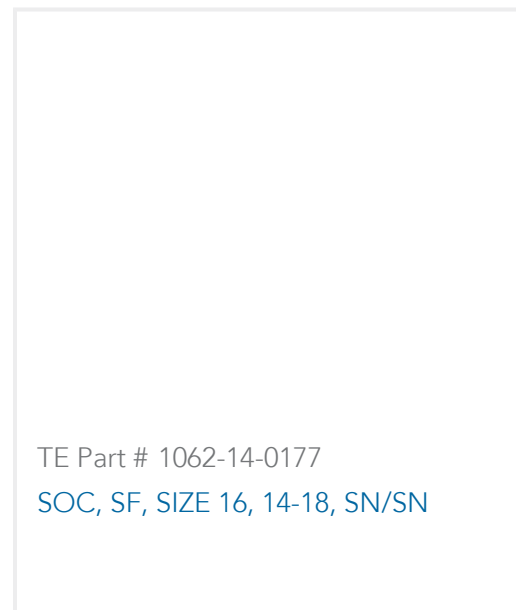

TE Part # 1062-14-0177
SOC, SF, SIZE 16, 14-18, SN/SN



TE Part # CAT-J67-DSCC16
DEUTSCH Size 16 Crimp Contacts

Also in the Series | **STRIKE**



Automotive Headers(10)

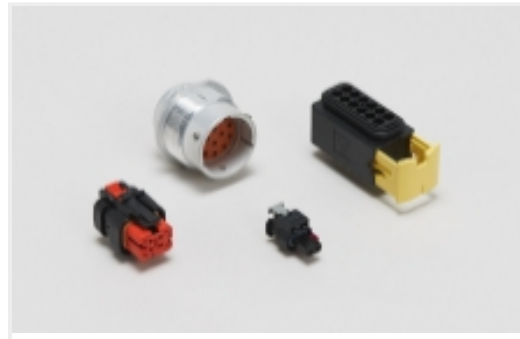

Automotive Housings(20)

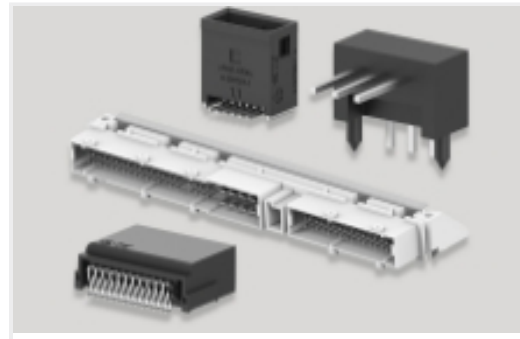

PCB Headers & Receptacles(10)

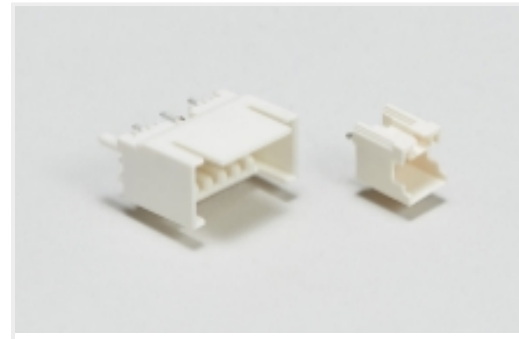

Wire-to-Board Headers & Receptacles (10)

Customers Also Bought



TE Part #CAT-AM71-CH8172
AMP SUPERSEAL 1.5MM,
CONNECTOR HOUSING



TE Part #206070-8
CABLE CLAMP KIT #17



TE Part #DT04-2P
REC, 2P, GRY, N



TE Part #DT06-2S
PLG, 2P, GRY, N



TE Part #CAT-D487-W416
Wedgelocks: DEUTSCH DT



TE Part #CAT-D48-ST273
DEUTSCH Solid Contacts

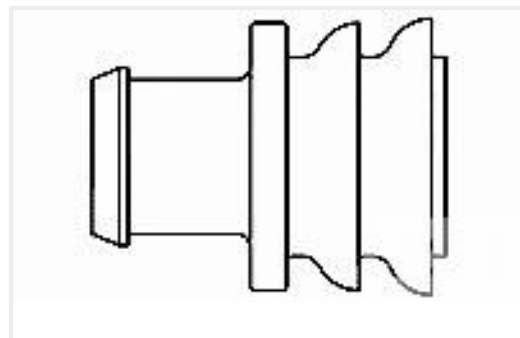

TE Part #281934-2
SINGLE WIRE SEAL

Documents

Product Drawings

PLG, 32P, BLK, E, I

English

CAD Files

3D PDF

3D

Customer View Model

[ENG_CVM_CVM_SRK06-MDI-32A-001_D.2d_dxf.zip](#)

English

Customer View Model

[ENG_CVM_CVM_SRK06-MDI-32A-001_D.3d_igs.zip](#)

English

Customer View Model

[ENG_CVM_CVM_SRK06-MDI-32A-001_D.3d_stp.zip](#)

English

By downloading the CAD file I accept and agree to the [Terms and Conditions](#) of use.



Datasheets & Catalog Pages

TERMINALS AND CONNECTORS

English

Product Specifications

Application Specification

English