



[All K-Type Tie-On Markers \(42\)](#)

**Product Compliance**

[For compliance documentation, visit the product page on TE.com>](#)

EU RoHS Directive 2011/65/EU	Compliant
EU ELV Directive 2000/53/EC	Compliant
China RoHS 2 Directive MIIT Order No 32, 2016	有害物质含量符合标准要求 No Restricted Substance(s) Above Threshold
EU REACH Regulation (EC) No. 1907/2006	Current ECHA Candidate List: JUNE 2025 (250) Candidate List Declared Against: JUNE 2025 (250) Does not contain REACH SVHC
Halogen Content	Not Low Halogen - contains Br or Cl > 900 ppm.
Solder Process Capability	Not applicable for solder process capability

Product Compliance Disclaimer

This information is provided based on reasonable inquiry of our suppliers and represents our current actual knowledge based on the information they provided. This information is subject to change. The part numbers that TE has identified as EU RoHS compliant have a maximum concentration of 0.1% by weight in homogenous materials for lead, hexavalent chromium, mercury, PBB, PBDE, DBP, BBP, DEHP, DIBP, and 0.01% for cadmium, or qualify for an exemption to these limits as defined in the Annexes of Directive 2011/65/EU (RoHS2). Finished electrical and electronic equipment products will be CE marked as required by Directive 2011/65/EU. Components may not be CE marked. Additionally, the part numbers that TE has identified as EU ELV compliant have a maximum concentration of 0.1% by weight in homogenous materials for lead, hexavalent chromium, and mercury, and 0.01% for cadmium, or qualify for an exemption to these limits as defined in the Annexes of Directive 2000/53/EC (ELV). Regarding the REACH Regulation, the information TE provides on SVHC in articles for this part number is based on the latest European Chemicals Agency (ECHA) 'Guidance on requirements for substances in articles' posted at this URL: <https://echa.europa.eu/guidance-documents/guidance-on-reach>

**Compatible Parts**

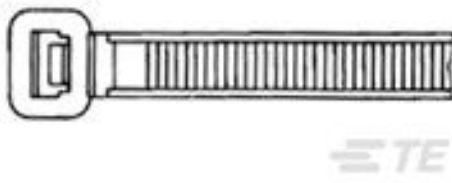

TE Part # 2-160977-2  
CABLE TY 290X4.8 BLA



TE Part # 2-160978-2  
CABLE TY 360X4,8BLA



TE Part # 2-160983-1  
CABLE TY 365X7.8 NAT



TE Part # CAT-T3437-K1  
K-Type Tie-On Markers

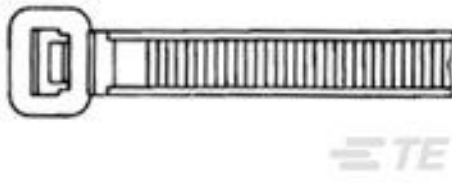

TE Part # 2-160984-2  
FOAC CABLE TY BLACK 460X7.8

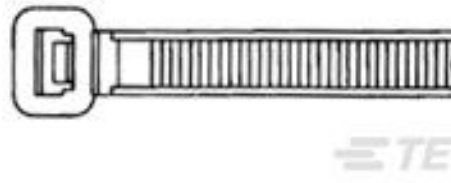

TE Part # 4-160996-2  
CABLE TY 200X3.6 BLA

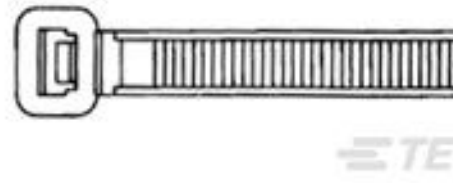

TE Part # 4-160968-1  
CABLE TY 134X2.6 NAT

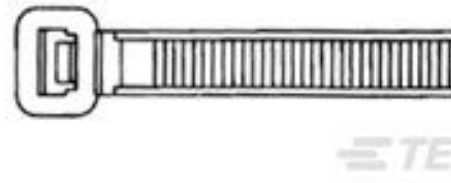

TE Part # 2-160971-2  
FOAC CABLE TY BLACK 140X3.6



TE Part # CAT-T3437-Z1  
Z-Type Push-On Markers

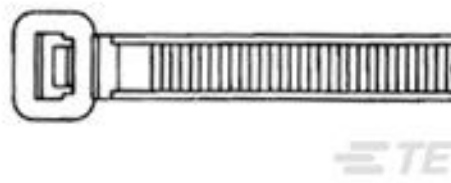

TE Part # 2-160968-2  
CABLE TY 134X2.6 BLACK

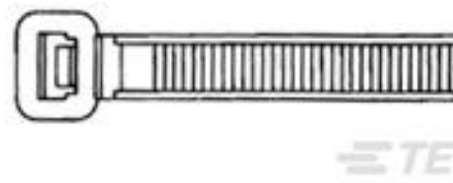

TE Part # 2-160968-1  
FOAC CABLE TY NATURAL 134X2.6

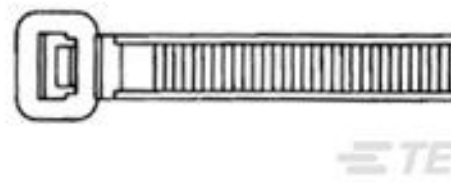

TE Part # 2-160986-2  
CABLE TY 750X7,8BLA



TE Part # 4-160971-2  
CABLE TY 140X3.6 BLACK

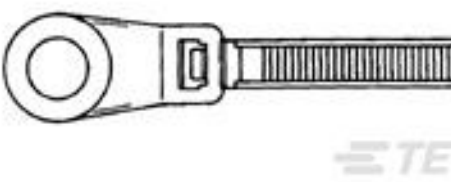

TE Part # 2-100715-1  
CABLE TY 150X3,6NAT

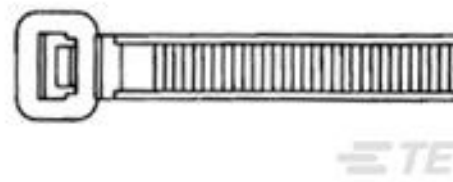

TE Part # 2-160981-2  
CABLE TY 240X7.5 BLACK

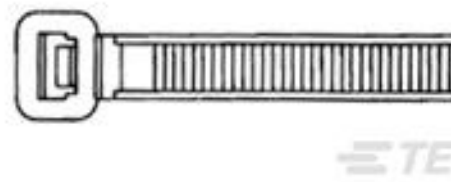

TE Part # 2-160975-1  
CABLE TY 200X4.8 NAT



TE Part # 4-160975-1  
CABLE TY 200X4.8 NAT

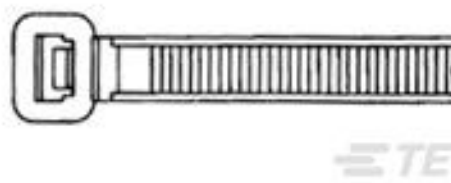

TE Part # 4-160968-2  
CABLE TY 134X2.6 BLACK

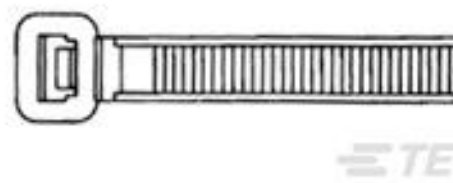

TE Part # 4-160970-1  
CABLE TY 200X2.6 NAT



TE Part # 4-160975-2  
CABLE TY 200X4.8 BLA

### Customers Also Bought



TE Part #CAT-T3437-K1  
K-Type Tie-On Markers



TE Part #F18659-000  
HX-SCE-1K-3.2-50-4

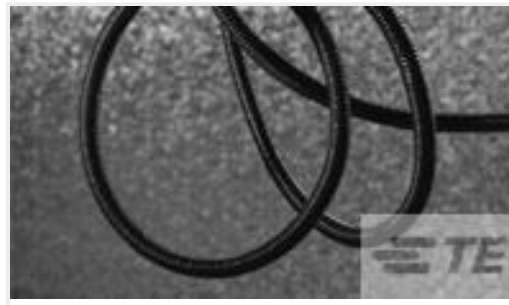

TE Part #3679754004  
HCTE-1000-0-SP

## Documents

### Datasheets & Catalog Pages

[Cable Identification Product Shelf Life](#)

English