

Product Compliance

[For compliance documentation, visit the product page on TE.com>](#)

EU RoHS Directive 2011/65/EU	Compliant
EU ELV Directive 2000/53/EC	Compliant
China RoHS 2 Directive MIIT Order No 32, 2016	有害物质含量符合标准要求 No Restricted Substance(s) Above Threshold
EU REACH Regulation (EC) No. 1907/2006	Current ECHA Candidate List: JUNE 2025 (250) Candidate List Declared Against: JUN 2018 (191) Does not contain REACH SVHC
Halogen Content	Low Halogen - Br, Cl, F < 900 ppm per homogenous material. Also BFR/CFR/PVC Free
Solder Process Capability	Not applicable for solder process capability

Product Compliance Disclaimer

This information is provided based on reasonable inquiry of our suppliers and represents our current actual knowledge based on the information they provided. This information is subject to change. The part numbers that TE has identified as EU RoHS compliant have a maximum concentration of 0.1% by weight in homogenous materials for lead, hexavalent chromium, mercury, PBB, PBDE, DBP, BBP, DEHP, DIBP, and 0.01% for cadmium, or qualify for an exemption to these limits as defined in the Annexes of Directive 2011/65/EU (RoHS2). Finished electrical and electronic equipment products will be CE marked as required by Directive 2011/65/EU. Components may not be CE marked. Additionally, the part numbers that TE has identified as EU ELV compliant have a maximum concentration of 0.1% by weight in homogenous materials for lead, hexavalent chromium, and mercury, and 0.01% for cadmium, or qualify for an exemption to these limits as defined in the Annexes of Directive 2000/53/EC (ELV). Regarding the REACH Regulation, the information TE provides on SVHC in articles for this part number is based on the latest European Chemicals Agency (ECHA) 'Guidance on requirements for substances in articles' posted at this URL: <https://echa.europa.eu/guidance-documents/guidance-on-reach>

Customers Also Bought



TE Part #CTJ-3A-12
RAIL ASSY

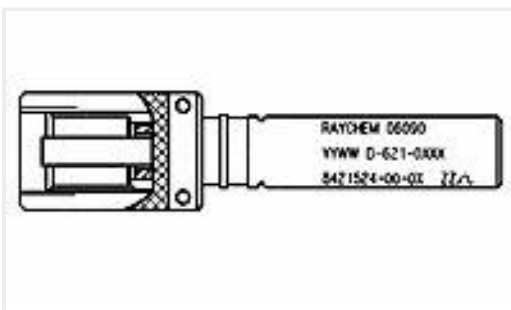

TE Part #435589-000
D-621-0413

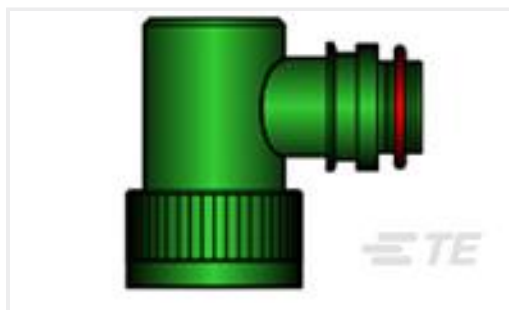

TE Part #356327-000
TXR40AB90-1008BI

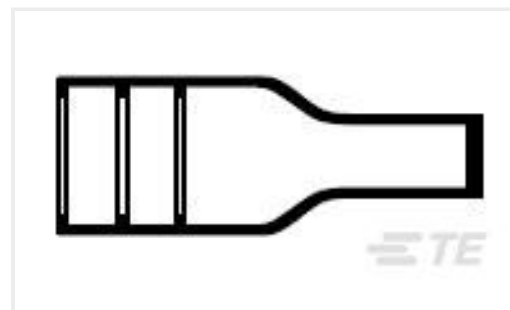

TE Part #632785-000
202D142-100/180-0

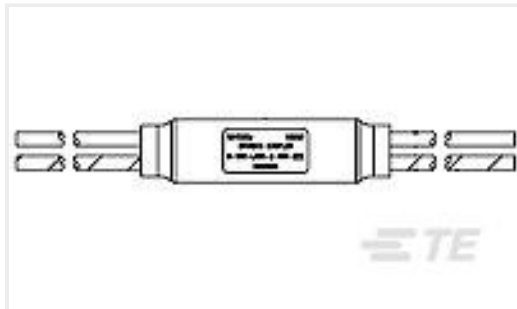

TE Part #CR8249-000
D-500-L455-2-612-120

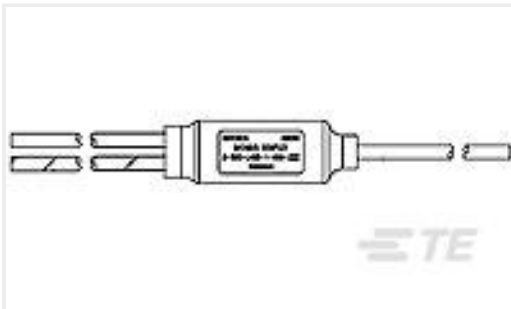

TE Part #D84971-000
D-500-L455-1-612-120



TE Part #F41443-000
D-500-L455-3-612-120

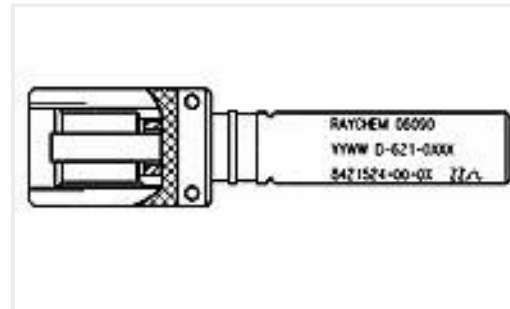

TE Part #364127-000
D-621-0415



TE Part #CF0008-000
HEX40-AB-00-11-A2-3

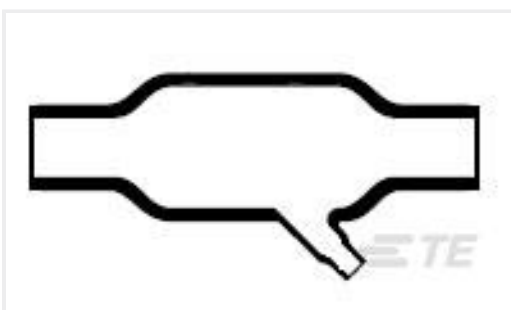

TE Part #129477-000
342A012-100-CS-1972-0

Documents

Product Drawings

[SLC40AC-1006A](#)

English

Datasheets & Catalog Pages

[Spin-Lock Variable Angle Backshell](#)

English

Product Specifications

[Spin-Lock Adapter Ordering Information](#)

English

[Assembly Guide for Raychem Spin-Lock Adapter with Aluminum Strain Relief](#)

English