



RAYCHEM | RAYCHEM RNF-3000

TE Internal #: 8555842002

Heat Shrink Tubing, Yellow, 3:1, Single Wall Tubing, Shrinks To 6 mm [.236 in], Irradiated Modified Polyolefin, RAYCHEM RNF-3000

[View on TE.com >](#)

Heat Shrink Tubing > RNF-3000 Heat Shrink Tubing

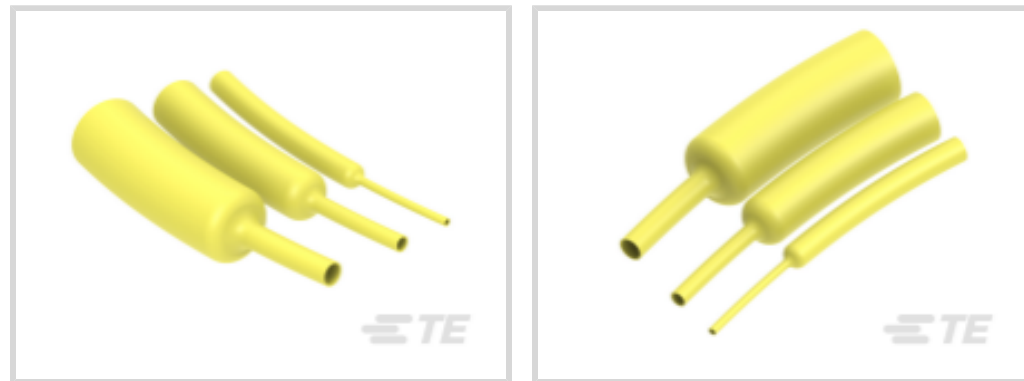

Tubing Product Type: **Heat Shrink Tubing**

Primary Product Color: **Yellow**

Shrink Ratio: **3:1**

Wall Type: **Single Wall**

Recovered Inside Diameter (Max): **6 mm [.236 in]**

[All RNF-3000 Heat Shrink Tubing \(209\)](#)

Features

Electrical Characteristics

Operating Voltage (Max)	.6 kV
-------------------------	-------

Usage Conditions

Shrink Temperature (Min)	80 °C
Tubing Flammability Type	Flame-Retardant
Operating Temperature Range	-55 – 135 °C
Recovery Temperature	120 °C

Dimensions

Recovered Wall Thickness (Nominal)	.85 mm[.033 in]
Product Length	1220 mm[48.031 in]
Recovered Wall Thickness (Tolerance)	.12 mm[.004 in]
Recovered Inside Diameter (Max)	6 mm[.236 in]
Expanded Inside Diameter (Min)	18 mm[.709 in]
Tubing Size Range	6 – 18 mm[.236 – .709 in]

Body Features

Fluid Type	Lubricating Oil, Hydraulic Fluid, Water, Gasoline
Primary Product Color	Yellow



Shrink Ratio	3:1
Primary Product Material	Irradiated Modified Polyolefin
Flexibility	Flexible

Product Type Features

Tubing Product Type	Heat Shrink Tubing
Wall Type	Single Wall

Packaging Features

Packaging Method	Stick
------------------	-------

Operation/Application

Mechanical Resistance	Mechanical Damage, Strain Relief, Fluids, Abrasion
-----------------------	--

Product Availability

Applicable Region	Global
-------------------	--------

Other

Meets Low Outgassing Requirements	No
Product Source	Czech Republic
EU RoHS Compliance	Compliant
EU ELV Compliance	Compliant

Product Compliance

[For compliance documentation, visit the product page on TE.com>](#)

EU RoHS Directive 2011/65/EU	Compliant
EU ELV Directive 2000/53/EC	Compliant
China RoHS 2 Directive MIIT Order No 32, 2016	No Restricted Materials Above Threshold
EU REACH Regulation (EC) No. 1907/2006	Current ECHA Candidate List: JUNE 2024 (241) Candidate List Declared Against: JUNE 2024 (241) Does not contain REACH SVHC
Halogen Content	Not Low Halogen - contains Br or Cl > 900 ppm.
Solder Process Capability	Not applicable for solder process capability

Product Compliance Disclaimer



This information is provided based on reasonable inquiry of our suppliers and represents our current actual knowledge based on the information they provided. This information is subject to change. The part numbers that TE has identified as EU RoHS compliant have a maximum concentration of 0.1% by weight in homogenous materials for lead, hexavalent chromium, mercury, PBB, PBDE, DBP, BBP, DEHP, DIBP, and 0.01% for cadmium, or qualify for an exemption to these limits as defined in the Annexes of Directive 2011/65/EU (RoHS2). Finished electrical and electronic equipment products will be CE marked as required by Directive 2011/65/EU. Components may not be CE marked. Additionally, the part numbers that TE has identified as EU ELV compliant have a maximum concentration of 0.1% by weight in homogenous materials for lead, hexavalent chromium, and mercury, and 0.01% for cadmium, or qualify for an exemption to these limits as defined in the Annexes of Directive 2000/53/EC (ELV). Regarding the REACH Regulation, the information TE provides on SVHC in articles for this part number is based on the latest European Chemicals Agency (ECHA) 'Guidance on requirements for substances in articles' posted at this URL: <https://echa.europa.eu/guidance-documents/guidance-on-reach>

Compatible Parts



TE Part # EG1114-000
CV1981-ST-230V1600W-EU

Also in the Series | RAYCHEM RNF-3000

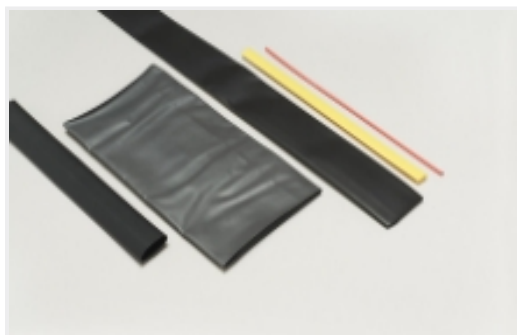

Heat Shrink Tubing(209)



Orange Heat Shrink Tubing(11)



Single Wall Tubing(209)

Customers Also Bought

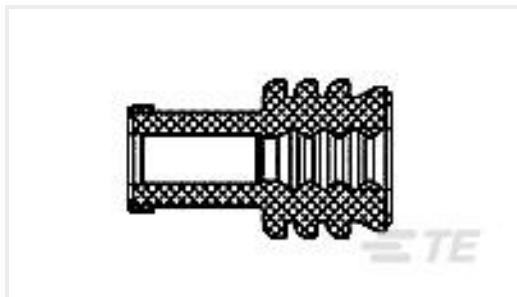

TE Part #1393457-4
V23540M1000Z110=DICHTTULLE (F1)

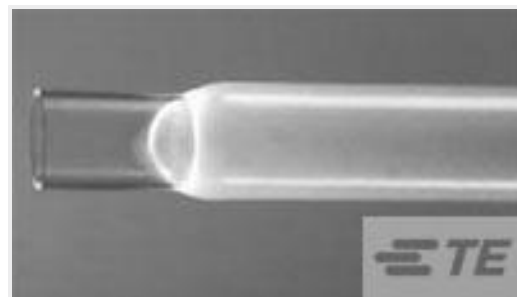

TE Part #5960092001
TFER-1-1/4-X-STK



TE Part #171637-1
MINI U-M-N-L SOCKET CONTACT

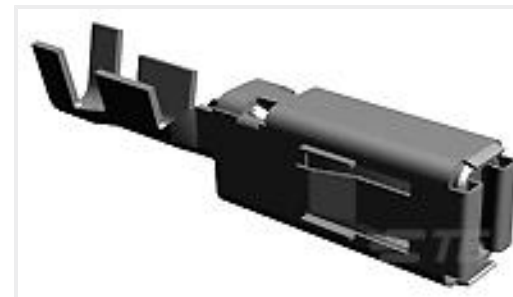

TE Part #1-968853-1
AMP MCP 2.8, CONTACT

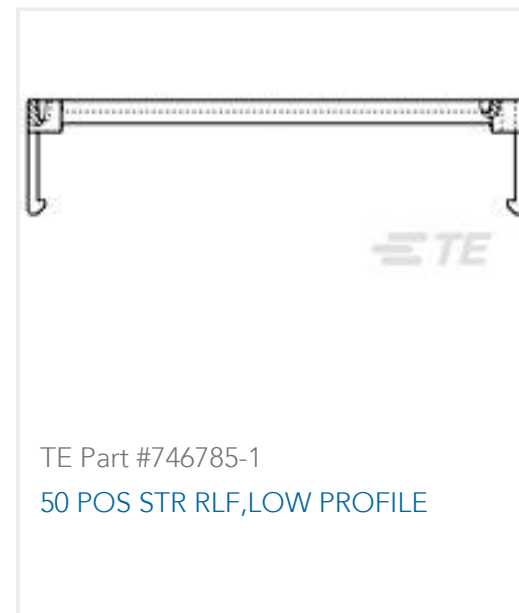
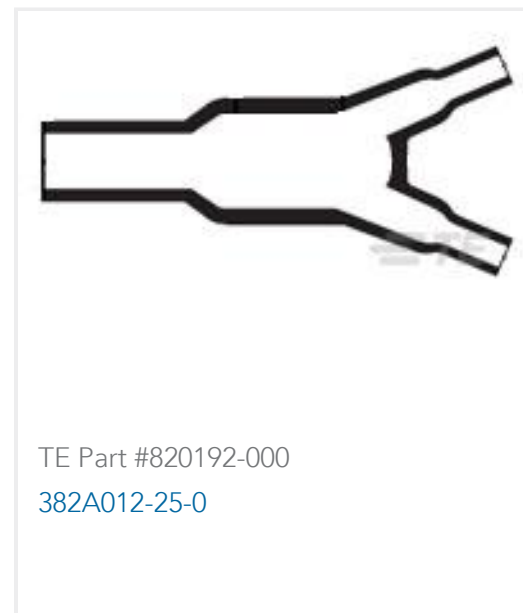

Documents

Product Drawings

[RNF-3000-18/6-4-STK](#)

English

Datasheets & Catalog Pages

[RNF-300 Tubing](#)

English

Product Specifications

[Application Specification](#)

English