

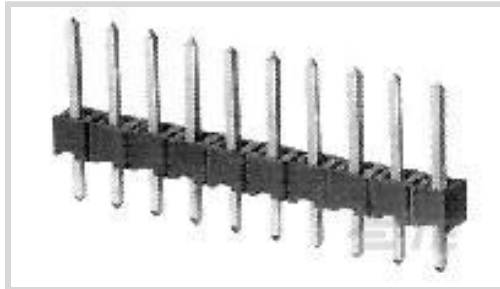

Connectors > PCB Connectors > PCB Headers & Receptacles

PCB Connector Assembly Type: **PCB Mount Header**PCB Mount Orientation: **Vertical**Connector System: **Board-to-Board**Number of Positions: **3**Number of Rows: **1**

Features

Dimensions

PCB Thickness (Recommended)	1.57 mm[.062 in]
-----------------------------	------------------

Electrical Characteristics

Insulation Resistance	5000 MΩ
Dielectric Withstanding Voltage (Max)	750 Vrms

Packaging Features

Packaging Quantity	1500
Packaging Method	Box

Usage Conditions

Housing Temperature Rating	Standard
Operating Temperature Range	-65 – 105 °C[-85 – 221 °F]

Termination Features

Termination Post & Tail Length	3.2 mm[.126 in]
Square Termination Post & Tail Dimension	.64 mm[.025 in]
Termination Method to PCB	Through Hole - Solder

Contact Features

Contact Underplating Material	Nickel
Contact Mating Area Plating Material Thickness	3 μm[118.11 μin]
Mating Square Post Dimension	.64 mm[.025 in]



PCB Contact Termination Area Plating Material Thickness	2 µm
Contact Shape & Form	Square
Contact Base Material	Phosphor Bronze
PCB Contact Termination Area Plating Material	Tin
Contact Mating Area Plating Material	Tin
Contact Type	Pin
Contact Current Rating (Max)	5 A

Housing Features

Housing Material	PBT
Centerline (Pitch)	2.54 mm [.1 in]

Configuration Features

Connector Contact Load Condition	Fully Loaded
Board-to-Board Configuration	Parallel
PCB Mount Orientation	Vertical
Number of Positions	3
Number of Rows	1

Product Type Features

PCB Connector Assembly Type	PCB Mount Header
Connector System	Board-to-Board
Header Type	Breakaway
Sealable	No
Connector & Contact Terminates To	Printed Circuit Board

Body Features

Primary Product Color	Green
-----------------------	-------

Mechanical Attachment

PCB Mount Retention	Without
PCB Mount Alignment	Without
Connector Mounting Type	Board Mount
Mating Alignment	Without

Operation/Application

Circuit Application	Signal
---------------------	--------

Industry Standards



UL Flammability Rating	UL 94V-0
------------------------	----------

Other

EU RoHS Compliance	Compliant
EU ELV Compliance	Compliant

Product Compliance

[For compliance documentation, visit the product page on TE.com>](#)

EU RoHS Directive 2011/65/EU	Compliant
EU ELV Directive 2000/53/EC	Compliant
China RoHS 2 Directive MIIT Order No 32, 2016	No Restricted Materials Above Threshold
EU REACH Regulation (EC) No. 1907/2006	Current ECHA Candidate List: JUNE 2024 (241) Candidate List Declared Against: JUNE 2024 (241) Does not contain REACH SVHC
Halogen Content	Not Low Halogen - contains Br or Cl > 900 ppm.
Solder Process Capability	Wave solder capable to 265°C

Product Compliance Disclaimer

This information is provided based on reasonable inquiry of our suppliers and represents our current actual knowledge based on the information they provided. This information is subject to change. The part numbers that TE has identified as EU RoHS compliant have a maximum concentration of 0.1% by weight in homogenous materials for lead, hexavalent chromium, mercury, PBB, PBDE, DBP, BBP, DEHP, DIBP, and 0.01% for cadmium, or qualify for an exemption to these limits as defined in the Annexes of Directive 2011/65/EU (RoHS2). Finished electrical and electronic equipment products will be CE marked as required by Directive 2011/65/EU. Components may not be CE marked. Additionally, the part numbers that TE has identified as EU ELV compliant have a maximum concentration of 0.1% by weight in homogenous materials for lead, hexavalent chromium, and mercury, and 0.01% for cadmium, or qualify for an exemption to these limits as defined in the Annexes of Directive 2000/53/EC (ELV). Regarding the REACH Regulation, the information TE provides on SVHC in articles for this part number is based on the latest European Chemicals Agency (ECHA) 'Guidance on requirements for substances in articles' posted at this URL: <https://echa.europa.eu/guidance-documents/guidance-on-reach>

Compatible Parts





Also in the Series | AMPMODU Headers



Automotive Headers(1)

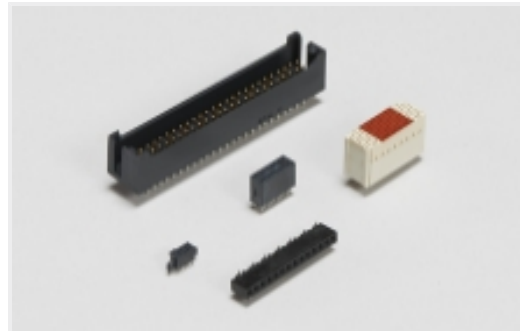

Board-to-Board Headers & Receptacles(1575)



Connector Contacts(52)

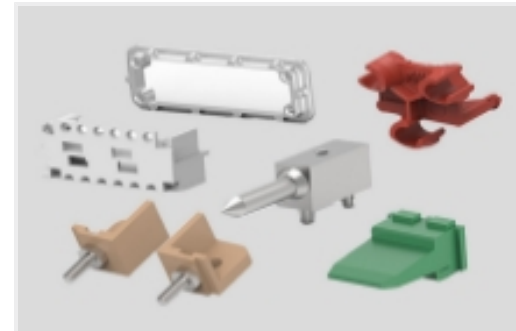

Connector Hardware(1)

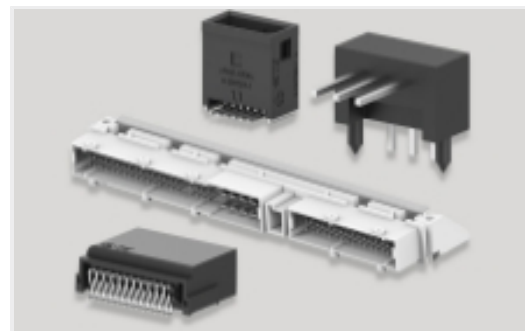

PCB Headers & Receptacles(1620)



Wire-to-Board Connector Assemblies & Housings(5)

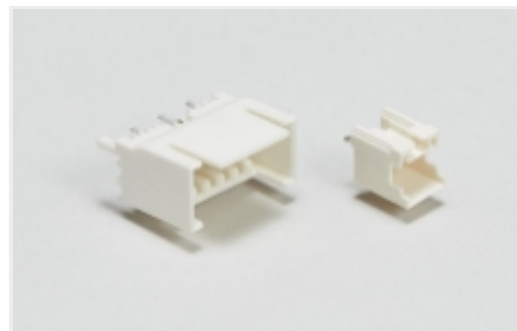

Wire-to-Board Headers & Receptacles (114)

Customers Also Bought



TE Part #953466-1
18W MQS HEADER ASS



TE Part #292331-3
BATTERY 3P SMT 1.6MM PITCH ASSEMBLY CONN

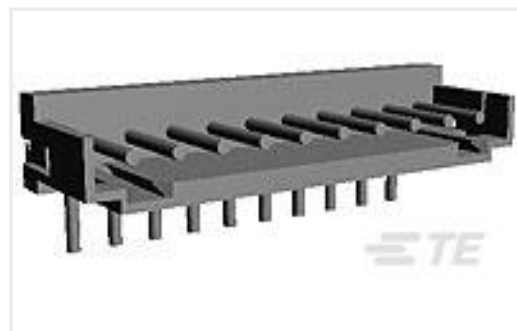

TE Part #1-292253-5
CT CONN MT HDR ASSY H 15P NAT



TE Part #CAT-H857-H34225
AMP HPI 2.5 mm Headers



TE Part #103906-1
02 MTE HDR SRRA LATCH .100CL

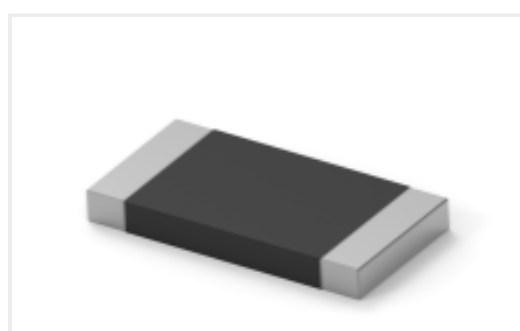

TE Part #5-2176421-3
TLRP 2512 2.0W R020 1% 50PPM 4K RL



TE Part #3-2176344-9
CRGCQ 1206 2M2 5%



TE Part #2-338313-2
9P.HDP20 REC. ASSY



TE Part #819692-SF
RC112-0.25-47M



Documents

Product Drawings

[3P AMPMODU II STIFT LEI](#)

English

CAD Files

[3D PDF](#)

English

Customer View Model

[ENG_CVM_826938-3_O.3d_igs.zip](#)

English

Customer View Model

[ENG_CVM_826938-3_O.3d_stp.zip](#)

English

Customer View Model

[ENG_CVM_826938-3_O.2d_dxf.zip](#)

English

[3D PDF](#)

3D

Customer View Model

[ENG_CVM_CVM_826938-3_J.2d_dxf.zip](#)

English

Customer View Model

[ENG_CVM_CVM_826938-3_J.3d_igs.zip](#)

English

Customer View Model

[ENG_CVM_CVM_826938-3_J.3d_stp.zip](#)

English

By downloading the CAD file I accept and agree to the [Terms and Conditions](#) of use.

Agency Approvals

[UL Report](#)

English