

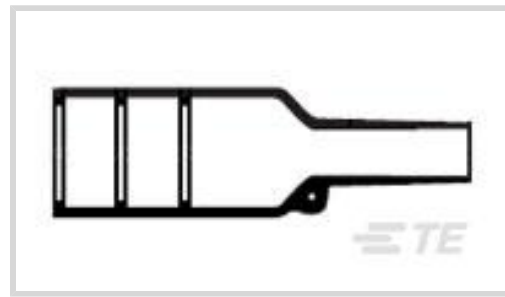

Wire Protection & Management > Heat Shrink Shapes > Heat Shrink Boots > Bulbous Heat Shrink Boots: Lipped, Straight



Body Orientation: **Straight**

Molded Part Shape Code: **202**

Lipped: **Yes**

Material Code: **3**

Material Systems Code: **10**

[All Bulbous Heat Shrink Boots: Lipped, Straight \(360\)](#)

Features

Industry Standards

Compatible With Approved Standards Products	SAE AS81765/1 Type I
---	----------------------

Dimensions

Expanded Inside Diameter (Min)	43 mm[1.69 in]
--------------------------------	----------------

Body Features

Primary Product Material	Semi-Rigid Modified Polyolefin
Material Code	3
Material Systems Code	10

Configuration Features

Lipped	Yes
Adhesive Requirement	Adhesive Purchased Separately

Housing Features

Body Orientation	Straight
------------------	----------

Usage Conditions

Operating Temperature Range	-55 – 135 °C[-67 – 275 °F]
Resistance Protection	Occasional Fluid Exposure

Other

Molded Part Shape Code	202
------------------------	-----



EU RoHS Compliance	Compliant
EU ELV Compliance	Compliant

Product Compliance

[For compliance documentation, visit the product page on TE.com>](#)

EU RoHS Directive 2011/65/EU	Compliant
EU ELV Directive 2000/53/EC	Compliant
China RoHS 2 Directive MIIT Order No 32, 2016	No Restricted Materials Above Threshold
EU REACH Regulation (EC) No. 1907/2006	Current ECHA Candidate List: JUNE 2024 (241) Candidate List Declared Against: JAN 2024 (240) Does not contain REACH SVHC
Halogen Content	Not Low Halogen - contains Br or Cl > 900 ppm.
Solder Process Capability	Not applicable for solder process capability

Product Compliance Disclaimer

This information is provided based on reasonable inquiry of our suppliers and represents our current actual knowledge based on the information they provided. This information is subject to change. The part numbers that TE has identified as EU RoHS compliant have a maximum concentration of 0.1% by weight in homogenous materials for lead, hexavalent chromium, mercury, PBB, PBDE, DBP, BBP, DEHP, DIBP, and 0.01% for cadmium, or qualify for an exemption to these limits as defined in the Annexes of Directive 2011/65/EU (RoHS2). Finished electrical and electronic equipment products will be CE marked as required by Directive 2011/65/EU. Components may not be CE marked. Additionally, the part numbers that TE has identified as EU ELV compliant have a maximum concentration of 0.1% by weight in homogenous materials for lead, hexavalent chromium, and mercury, and 0.01% for cadmium, or qualify for an exemption to these limits as defined in the Annexes of Directive 2000/53/EC (ELV). Regarding the REACH Regulation, the information TE provides on SVHC in articles for this part number is based on the latest European Chemicals Agency (ECHA) 'Guidance on requirements for substances in articles' posted at this URL: <https://echa.europa.eu/guidance-documents/guidance-on-reach>

Compatible Parts



Customers Also Bought



TE Part #5053224021
RNF-100-1/2-6-SP

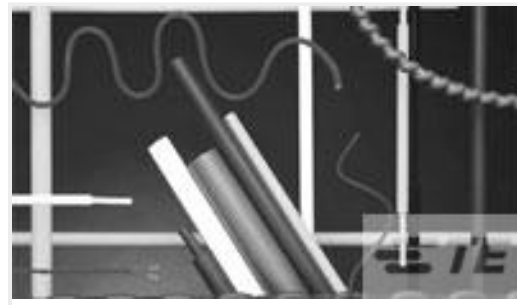

TE Part #5068234005
CGPT-25.4/12.7-4-SP

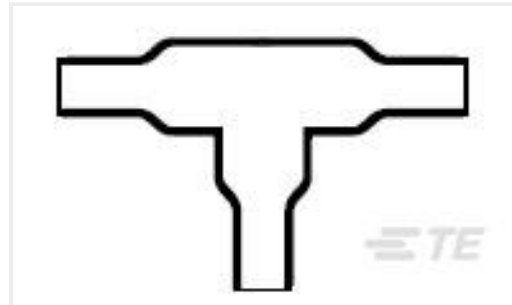

TE Part #811140-000
301A011-12-0



TE Part #C57207-000
MP-381127-5-8A

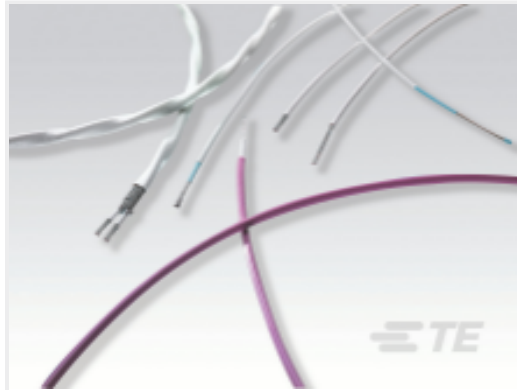

TE Part #E205483001
55M1414-26-9-9

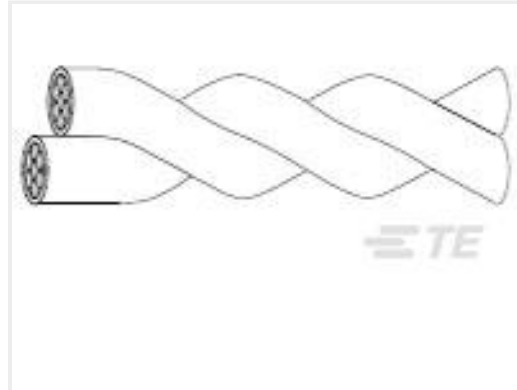

TE Part #3832633017
44A0121-18-0/9

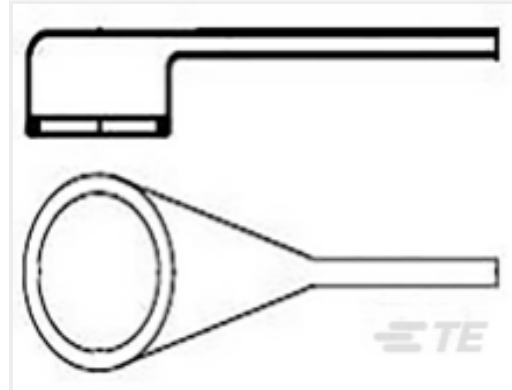

TE Part #CAT-R21-7310554
Heat Shrink Boots: Lipped, Right Angle



TE Part #A51165-000
WP-318097-10-9

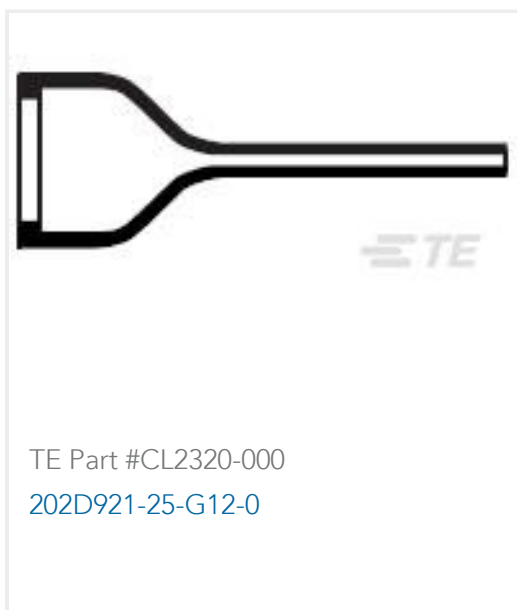

TE Part #CL2320-000
202D921-25-G12-0

Documents

Product Drawings

[202K163-3-G03-0](#)

English

Datasheets & Catalog Pages

[1654025_Sec4_-3](#)

English

Raychem Molded Parts Visual Guide

English

Product Specifications

[Product Specification](#)

English