

8-1241983-2 ✓ ACTIVE

[RAST](#) | [RAST 5 IDC Connectors](#)

TE Internal #: 8-1241983-2

Housing, Receptacle, Wire-to-Board, 2 Position, 5 mm [.197 in]
Centerline, Crimp, 1 Row, Black, Wire & Cable, Power & Signal,
RAST 5 IDC Connectors

[View on TE.com >](#)



[Connectors](#) > [PCB Connectors](#) > [Wire-to-Board Connectors](#) > [Wire-to-Board Connector Assemblies & Housings](#)

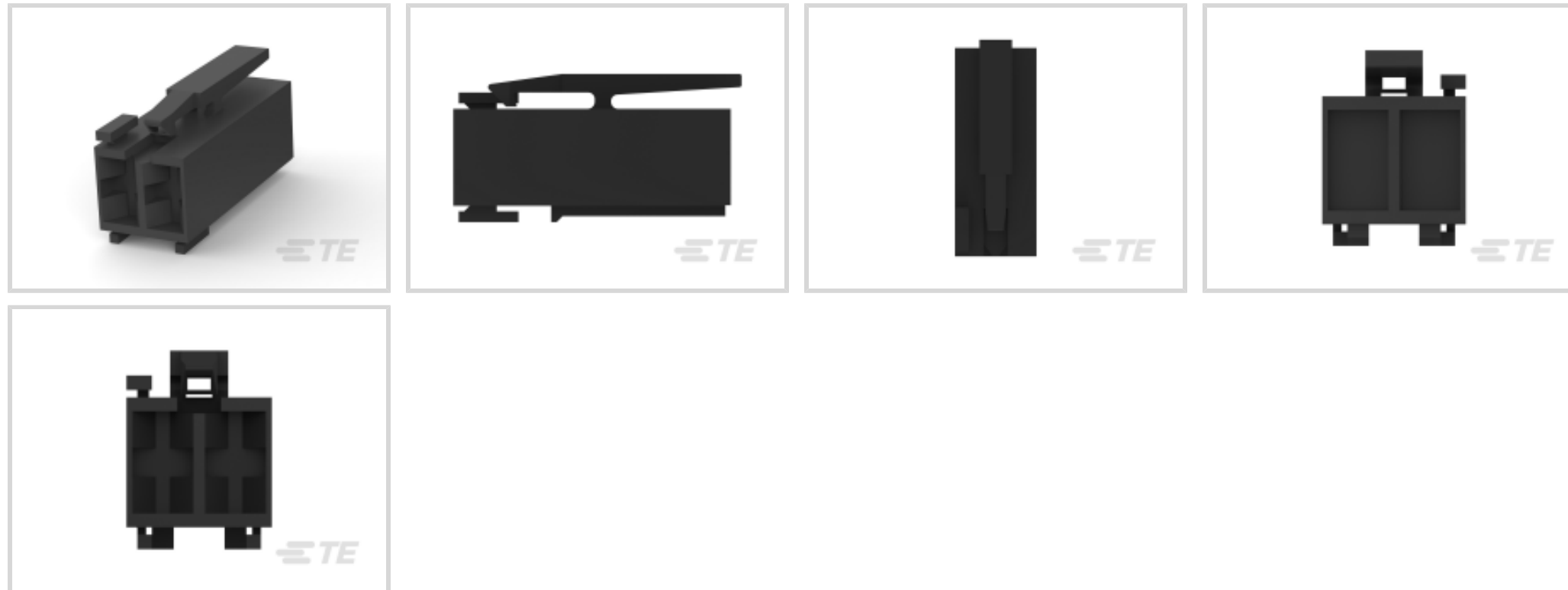

Connector Product Type: **Housing**

Connector & Housing Type: **Receptacle**

Connector System: **Wire-to-Board**

Number of Positions: **2**

Centerline (Pitch): **5 mm [.197 in]**

Features

Industry Standards

RAST Version	02-B
UL Flammability Rating	UL 94V-2
Glow Wire Rating	Glow Wire

Packaging Features

Packaging Method	Box
Packaging Quantity	3200

Dimensions

Connector Height	13.9 mm [.547 in]
Connector Length	1 mm, 25.5 mm

Mechanical Attachment

Strain Relief	Without
Locking Latch Between Cavity Number	1&2
Panel Mount Feature	Without
Mating Retention Type	Latch



PCB Mount Retention	Without
Mating Retention	With
Connector Mounting Type	Cable Mount (Free-Hanging)

Housing Features

Housing Material	PA 6
Housing Entry Configuration	Both Ends Closed
Centerline (Pitch)	5 mm [.197 in]

Configuration Features

Keying & Polarized Rib Location	1a,2b
Number of Positions	2
Number of Rows	1

Product Type Features

Connector Product Type	Housing
Connector & Housing Type	Receptacle
Connector System	Wire-to-Board
Sealable	No
Connector & Contact Terminates To	Wire & Cable

Body Features

Primary Product Color	Black
-----------------------	-------

Termination Features

Termination Method to Wire & Cable	Crimp
------------------------------------	-------

Usage Conditions

Operating Temperature Range	-40 – 105 °C [-40 – 221 °F]
-----------------------------	-----------------------------

Operation/Application

Circuit Application	Power & Signal
---------------------	----------------

Other

EU RoHS Compliance	Compliant
EU ELV Compliance	Compliant

Product Compliance

[For compliance documentation, visit the product page on TE.com>](#)



EU RoHS Directive 2011/65/EU	Compliant
EU ELV Directive 2000/53/EC	Compliant
China RoHS 2 Directive MIIT Order No 32, 2016	No Restricted Materials Above Threshold
EU REACH Regulation (EC) No. 1907/2006	Current ECHA Candidate List: JUNE 2024 (241) Candidate List Declared Against: JUNE 2024 (241) Does not contain REACH SVHC
Halogen Content	Not Low Halogen - contains Br or Cl > 900 ppm.
Solder Process Capability	Not applicable for solder process capability

Product Compliance Disclaimer

This information is provided based on reasonable inquiry of our suppliers and represents our current actual knowledge based on the information they provided. This information is subject to change. The part numbers that TE has identified as EU RoHS compliant have a maximum concentration of 0.1% by weight in homogenous materials for lead, hexavalent chromium, mercury, PBB, PBDE, DBP, BBP, DEHP, DIBP, and 0.01% for cadmium, or qualify for an exemption to these limits as defined in the Annexes of Directive 2011/65/EU (RoHS2). Finished electrical and electronic equipment products will be CE marked as required by Directive 2011/65/EU. Components may not be CE marked. Additionally, the part numbers that TE has identified as EU ELV compliant have a maximum concentration of 0.1% by weight in homogenous materials for lead, hexavalent chromium, and mercury, and 0.01% for cadmium, or qualify for an exemption to these limits as defined in the Annexes of Directive 2000/53/EC (ELV). Regarding the REACH Regulation, the information TE provides on SVHC in articles for this part number is based on the latest European Chemicals Agency (ECHA) 'Guidance on requirements for substances in articles' posted at this URL: <https://echa.europa.eu/guidance-documents/guidance-on-reach>

Compatible Parts

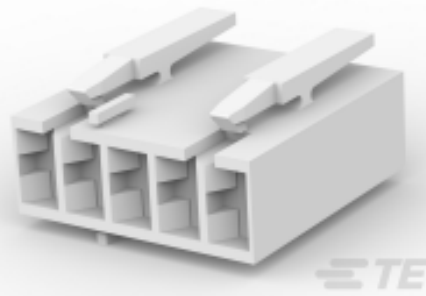
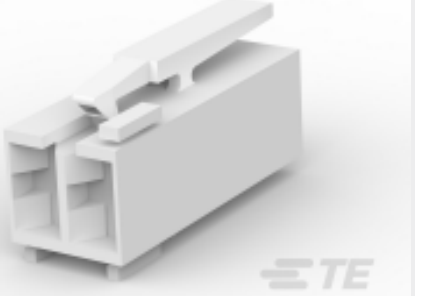
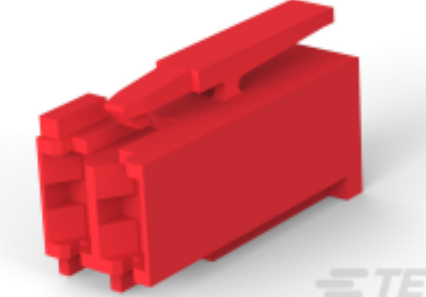
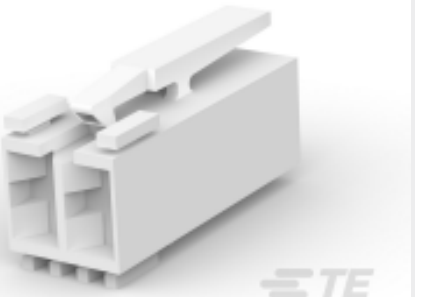
 <p>TE Part # 1241959-5 STD-TIM HSG MKII 5P</p>	 <p>TE Part # 3-1241965-2 STD TIMER HOUSING</p>	 <p>TE Part # 7-1241961-2 STD TIM HOUSING MKII 2POS</p>	 <p>TE Part # 1241965-2 STD TIMER HOUSING 2POS</p>
 <p>TE Part # 4-1241965-2 STD TIMER HOUSING</p>	 <p>TE Part # 5-1241965-2 2POS STANDARD TIMER HOUSING</p>	 <p>TE Part # 1241961-1 STD TIM HOUSING MKII 2POS</p>	 <p>TE Part # 8-1241961-2 STD TIM HOUSING MKII 2POS</p>



Also in the Series | RAST 5 IDC Connectors

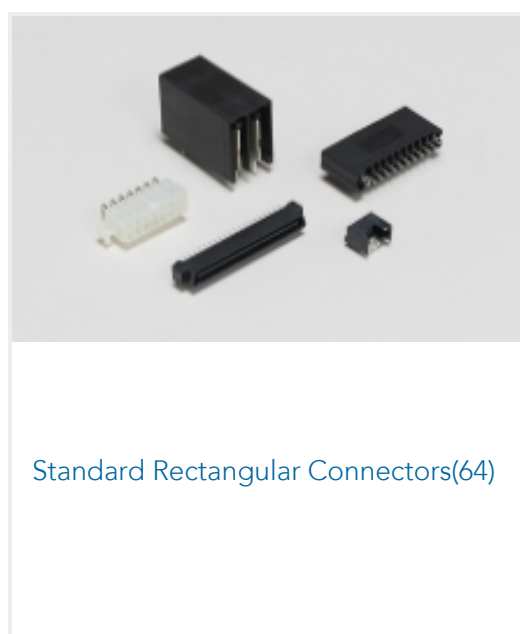
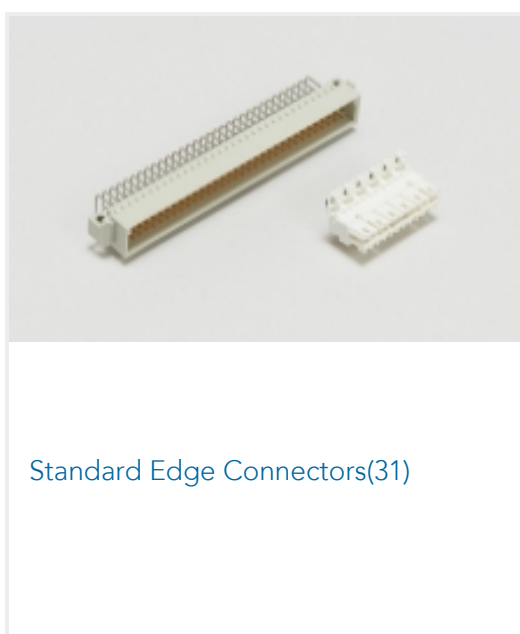
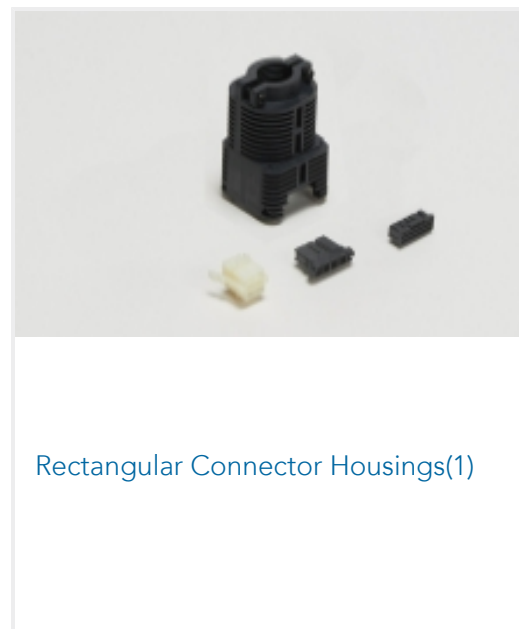
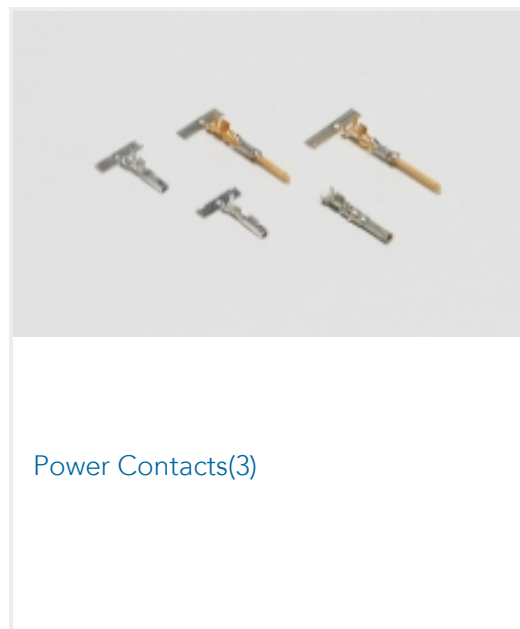
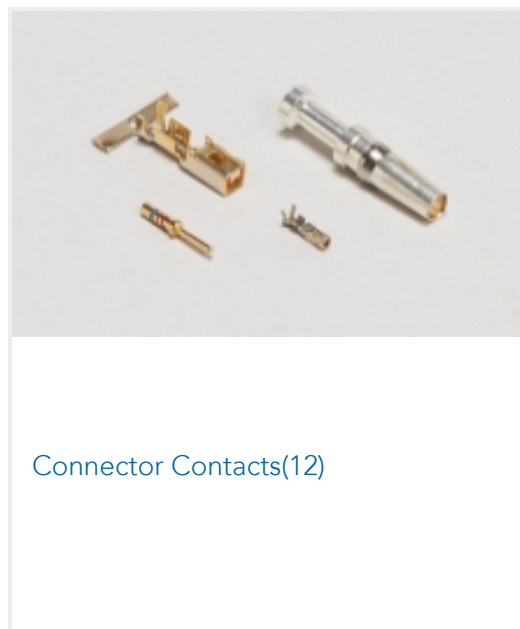
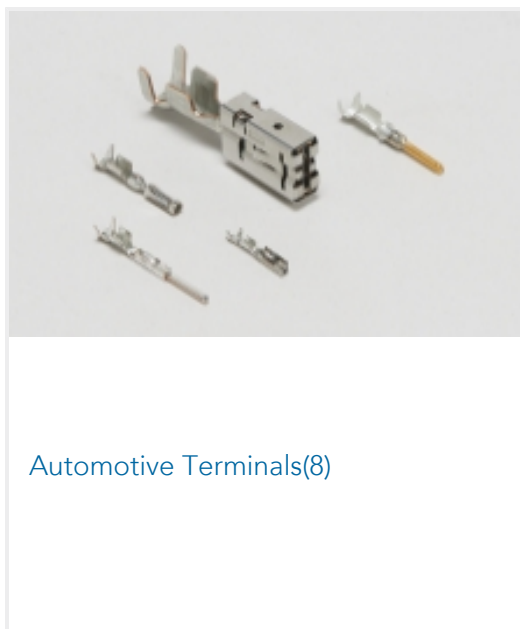

Customers Also Bought

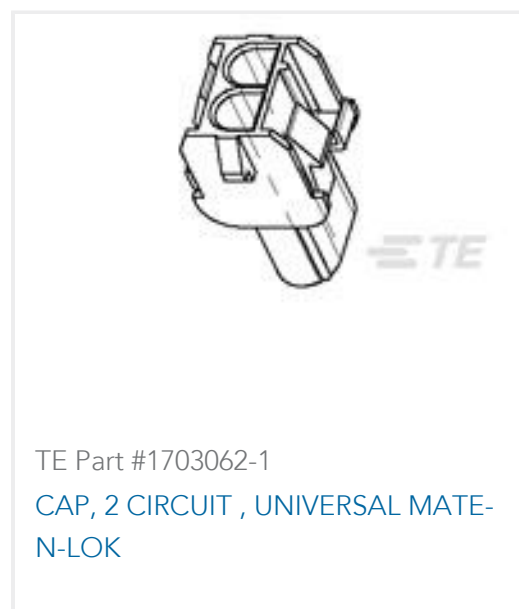



Documents

Product Drawings

STANDARD TIMER HOUSING MARK II

German

CAD Files

3D PDF

3D

Customer View Model

[ENG_CVM_CVM_8-1241983-2_C_c-8-1241983-2-c.2d_dxf.zip](#)

English

Customer View Model

[ENG_CVM_CVM_8-1241983-2_C_c-8-1241983-2-c.3d_igs.zip](#)

English

Customer View Model

[ENG_CVM_CVM_8-1241983-2_C_c-8-1241983-2-c.3d_stp.zip](#)

English

By downloading the CAD file I accept and agree to the [Terms and Conditions](#) of use.

Datasheets & Catalog Pages

RAST Connector System Catalog

English

Product Specifications

Product Specification

German

Agency Approvals

VDE Certificate

8-1241983-2

Housing, Receptacle, Wire-to-Board, 2 Position, 5 mm [.197 in] Centerline, Crimp, 1 Row, Black, Wire & Cable, Power & Signal, RAST 5 IDC Connectors



English