

7-353908-8 ✓ ACTIVE

AMP Mini CT

TE Internal #: 7-353908-8

Housing, Receptacle, Wire-to-Board / Wire-to-Panel / Wire-to-Wire,
18 Position, 1.5 mm [.059 in] Centerline, Crimp, 1 Row, Blue, AMP
Mini CT

[View on TE.com >](#)



[Connectors >](#) [PCB Connectors >](#) [Wire-to-Board Connectors >](#) [Wire-to-Board Connector Assemblies & Housings >](#)

[Mini Common Termination \(CT\) Housings](#)



Connector Product Type: **Housing**

Connector & Housing Type: **Receptacle**

Connector System: **Wire-to-Board, Wire-to-Panel, Wire-to-Wire**

Number of Positions: **18**

Centerline (Pitch): **1.5 mm [.059 in]**

[All Mini Common Termination \(CT\) Housings \(38\)](#)

Features

Electrical Characteristics

Operating Voltage	50 VDC
Insulation Resistance	500 MΩ

Industry Standards

Compatible With Agency/Standards Products	UL, CSA
UL Flammability Rating	UL 94V-0
Glow Wire Rating	Standard Part - Not Glow Wire

Packaging Features

Packaging Method	Box
Packaging Quantity	500

Dimensions

Connector Width	3.6 mm[.141 in]
Compatible Insulation Diameter Range	.85 – 1.05 mm[.033 – .041 in]
Connector Height	6 mm[.236 in]
Wire Size	30 – 24 AWG
Connector Length	28.5 mm[1.122 in]

Contact Features



Contact Layout	Inline
Contact Type	Socket
Contact Current Rating (Max)	3 A

Mechanical Attachment

Strain Relief	Without
Panel Mount Feature	Without
Mating Retention Type	Detent
PCB Mount Retention	Without
Mating Retention	With
Connector Mounting Type	Cable Mount (Free-Hanging)

Housing Features

Housing Material	Nylon 66
Housing Entry Configuration	Both Ends Closed
Centerline (Pitch)	1.5 mm [.059 in]

Product Type Features

Connector Product Type	Housing
Connector & Housing Type	Receptacle
Connector System	Wire-to-Board, Wire-to-Panel, Wire-to-Wire
Sealable	No
Connector & Contact Terminates To	Wire & Cable

Configuration Features

Number of Positions	18
Number of Rows	1

Body Features

Primary Product Color	Blue
-----------------------	------

Termination Features

Termination Method to Wire & Cable	Crimp
------------------------------------	-------

Usage Conditions

Operating Temperature Range	-30 – 105 °C [-22 – 221 °F]
-----------------------------	-----------------------------

Operation/Application

Circuit Application	Power & Signal
---------------------	----------------

Other

EU RoHS Compliance	Compliant
--------------------	-----------

EU ELV Compliance	Compliant
-------------------	-----------

Product Compliance

[For compliance documentation, visit the product page on TE.com>](#)

EU RoHS Directive 2011/65/EU	Compliant
------------------------------	-----------

EU ELV Directive 2000/53/EC	Compliant
-----------------------------	-----------

China RoHS 2 Directive MIIT Order No 32, 2016	No Restricted Materials Above Threshold
---	---

EU REACH Regulation (EC) No. 1907/2006	Current ECHA Candidate List: JUNE 2024 (241) Candidate List Declared Against: JUNE 2024 (241) Does not contain REACH SVHC
--	---

Halogen Content	Low Halogen - Br, Cl, F, I < 900 ppm per homogenous material. Also BFR/CFR/PVC Free
-----------------	---

Solder Process Capability	Not applicable for solder process capability
---------------------------	--

Product Compliance Disclaimer

This information is provided based on reasonable inquiry of our suppliers and represents our current actual knowledge based on the information they provided. This information is subject to change. The part numbers that TE has identified as EU RoHS compliant have a maximum concentration of 0.1% by weight in homogenous materials for lead, hexavalent chromium, mercury, PBB, PBDE, DBP, BBP, DEHP, DIBP, and 0.01% for cadmium, or qualify for an exemption to these limits as defined in the Annexes of Directive 2011/65/EU (RoHS2). Finished electrical and electronic equipment products will be CE marked as required by Directive 2011/65/EU. Components may not be CE marked. Additionally, the part numbers that TE has identified as EU ELV compliant have a maximum concentration of 0.1% by weight in homogenous materials for lead, hexavalent chromium, and mercury, and 0.01% for cadmium, or qualify for an exemption to these limits as defined in the Annexes of Directive 2000/53/EC (ELV). Regarding the REACH Regulation, the information TE provides on SVHC in articles for this part number is based on the latest European Chemicals Agency (ECHA) 'Guidance on requirements for substances in articles' posted at this URL: <https://echa.europa.eu/guidance-documents/guidance-on-reach>

Compatible Parts

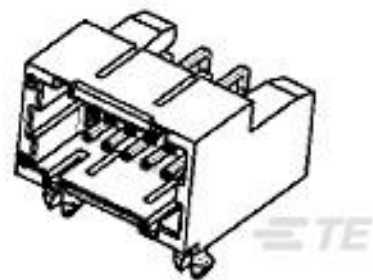

TE Part # 8-292262-6
DBL ROW (H) DIP TYPE WITH BOAR

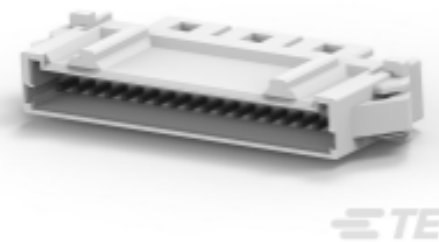

TE Part # 1-292215-8
MINI CT SGL RELAY 18P NAT

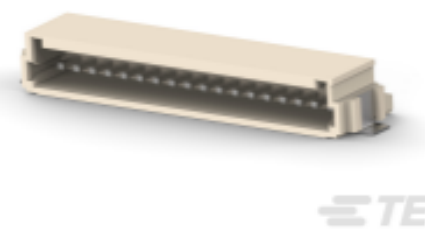

TE Part # 1-292228-8
1.5 MINI CT SGL H SMT W/O BOSS



TE Part # 1-292206-8
MINI CT SGL DIP H 18P NAT



TE Part # 1-292230-8
1.5 MINI CT SGL V SMT W/BOSS 1



TE Part # CAT-AM7053-C7671
Mini Common Termination Contacts



TE Part # 1-292231-8
1.5 MINI CT SGL V SMT W/O BOSS



TE Part # 1-292207-8
MINI CT SGL DIP V 18P NAT



TE Part # 1-292227-8
1.5 MINI CT SGL H SMT W BOSS 1

Also in the Series | AMP Mini CT



Connector Contacts(4)

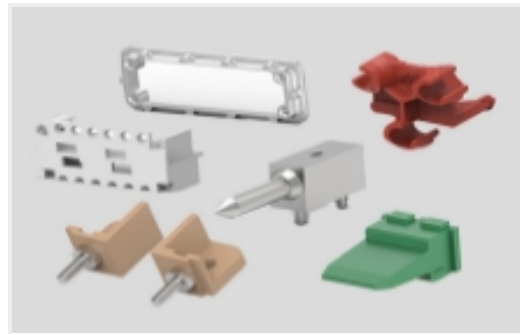

Connector Hardware(10)

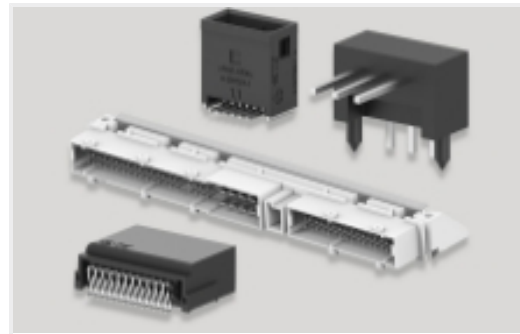

PCB Headers & Receptacles(332)



Wire-to-Board Connector Assemblies & Housings(172)

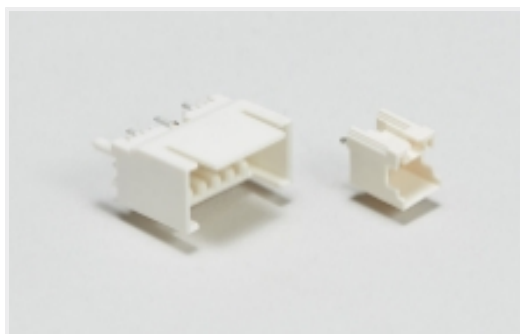

Wire-to-Board Headers & Receptacles (332)

Customers Also Bought



TE Part #206070-8
CABLE CLAMP KIT #17



TE Part #DT04-2P
REC, 2P, GRY, N



TE Part #DT06-2S
PLG, 2P, GRY, N



TE Part #CAT-D487-W416
Wedgelocks: DEUTSCH DT

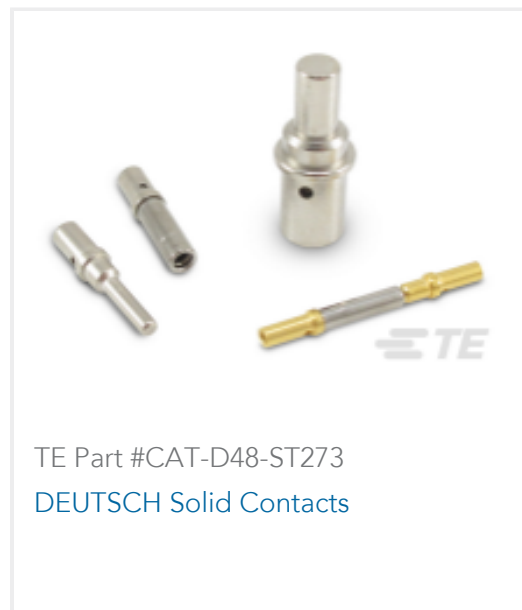

TE Part #CAT-D48-ST273
DEUTSCH Solid Contacts



TE Part #CAT-AM71-CH8172
AMP SUPERSEAL 1.5MM,
CONNECTOR HOUSING

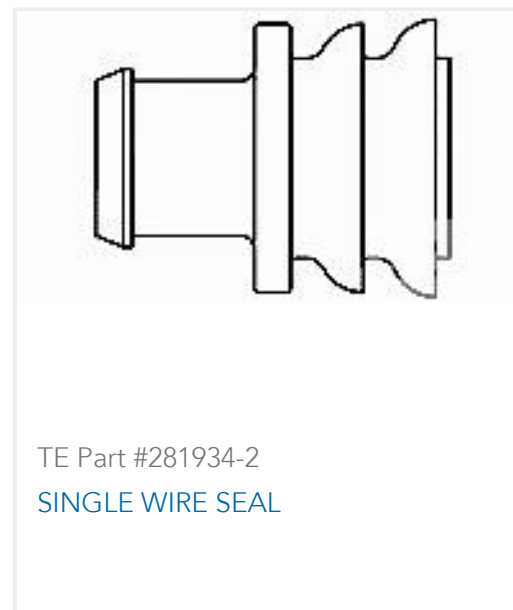

TE Part #281934-2
SINGLE WIRE SEAL

Documents

Product Drawings

CT REC HSG 18P CRIMP TYPE BLU

English

CAD Files

Customer View Model

[ENG_CVM_CVM_7-353908-8_P.2d_dxf.zip](#)

English

3D PDF

3D

Customer View Model

[ENG_CVM_CVM_7-353908-8_P.3d_igs.zip](#)

English

Customer View Model

[ENG_CVM_CVM_7-353908-8_P.3d_stp.zip](#)

English

By downloading the CAD file I accept and agree to the [Terms and Conditions](#) of use.

Product Specifications

Application Specification

English

Instruction Sheets

Instruction Sheet for Mini CT DC Drawer Connector SF Type

Japanese

Instruction Sheet (non U.S.)

English

1.5mm Pitch Mini CT DC Drawer Connector SF Type

Japanese

Instruction Sheet (non U.S.)

Japanese

1.5mm Pitch Mini CT Hybrid Drawer Connector SF Type

Japanese

Instruction Sheet (non U.S.)

Japanese



1.5mm Pitch Mini CT Hybrid Drawer Connector Slim Type

Japanese

Instruction Sheet (non U.S.)

Japanese