

FSP-24A-10 ✓ ACTIVE

TE Internal #: 7-1437167-9

Wire-to-Board, 10 Position, 2.54 mm [.1 in] Centerline, 101.6 mm [4 in] Length, Printed Circuit Board, Power & Signal, Wire-to-Board Jumpers & Shunts

[View on TE.com >](#)



Connectors > PCB Connectors > Wire-to-Board Connectors > Wire-to-Board Jumpers & Shunts

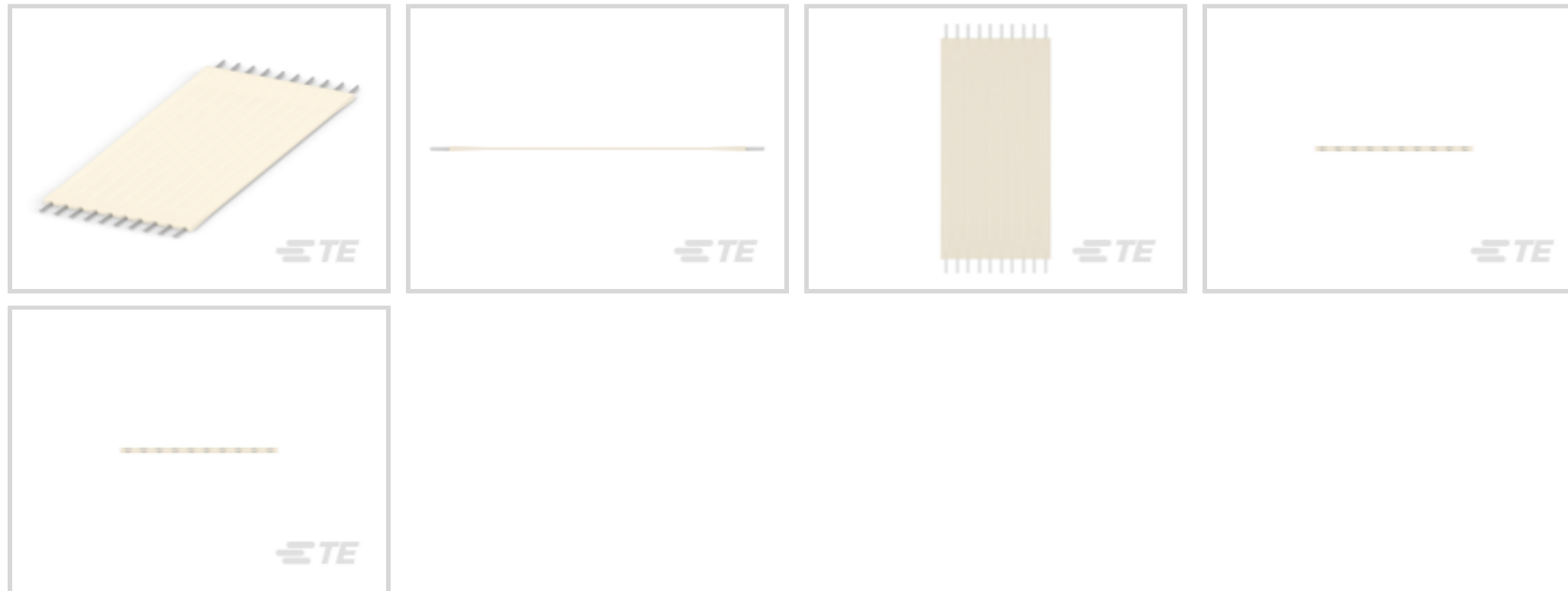

Connector System: **Wire-to-Board**

Number of Positions: **10**

Centerline (Pitch): **2.54 mm [.1 in]**

Product Length: **101.6 mm [4 in]**

Connector & Contact Terminates To: **Printed Circuit Board**

Features

Body Features

Jumper Insulation Material	Polyester
----------------------------	-----------

Electrical Characteristics

Operating Voltage	300 VAC
Impedance	115 Ω

Contact Features

Pin Arrangement (Right)	A
Pin Arrangement (Left)	A
Contact Current Rating (Max)	3 A

Dimensions

Wire Size	24 AWG
Product Length	101.6 mm[4 in]

Configuration Features

Number of Conductors	10
Number of Rows	1



Number of Positions	10
---------------------	----

Product Type Features

Compatible With Discrete Wire Type	Solid
Connector System	Wire-to-Board
Connector & Contact Terminates To	Printed Circuit Board

Housing Features

Centerline (Pitch)	2.54 mm [.1 in]
--------------------	-----------------

Usage Conditions

Operating Temperature Range	-40 – 105 °C [-40 – 221 °F]
-----------------------------	-----------------------------

Operation/Application

Circuit Application	Power & Signal
---------------------	----------------

Other

EU RoHS Compliance	Compliant
EU ELV Compliance	Compliant

Product Compliance

[For compliance documentation, visit the product page on TE.com>](#)

EU RoHS Directive 2011/65/EU	Compliant
EU ELV Directive 2000/53/EC	Compliant
China RoHS 2 Directive MIIT Order No 32, 2016	No Restricted Materials Above Threshold
EU REACH Regulation (EC) No. 1907/2006	Current ECHA Candidate List: JUNE 2024 (241) Candidate List Declared Against: JUNE 2024 (241) Does not contain REACH SVHC
Halogen Content	Low Halogen - Br, Cl, F, I < 900 ppm per homogenous material. Also BFR/CFR/PVC Free
Solder Process Capability	Not applicable for solder process capability

Product Compliance Disclaimer

This information is provided based on reasonable inquiry of our suppliers and represents our current actual knowledge based on the information they provided. This information is subject to change. The part numbers that TE has identified as EU RoHS compliant have a maximum concentration of 0.1% by weight in homogenous materials for lead, hexavalent chromium, mercury, PBB, PBDE, DBP, BBP, DEHP, DIBP, and 0.01% for cadmium, or qualify for an exemption to these limits as defined in the Annexes of Directive 2011/65/EU (RoHS2). Finished electrical and electronic equipment products will be CE marked as required by Directive 2011/65/EU. Components may not be CE marked. Additionally, the part numbers that TE has identified as EU ELV compliant have a maximum concentration of 0.1% by weight in homogenous materials for lead, hexavalent chromium, and mercury, and 0.01% for cadmium, or qualify for an exemption to these limits

as defined in the Annexes of Directive 2000/53/EC (ELV). Regarding the REACH Regulation, the information TE provides on SVHC in articles for this part number is based on the latest European Chemicals Agency (ECHA) 'Guidance on requirements for substances in articles' posted at this URL: <https://echa.europa.eu/guidance-documents/guidance-on-reach>

Compatible Parts

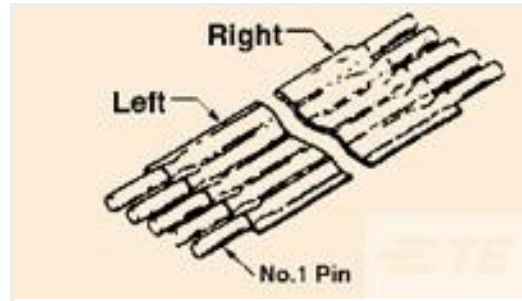

TE Part # 2-1437167-3
FSP-23A-12



TE Part # 3-1437167-4
FSP-23A-23



TE Part # 2-1437167-6
FSP-23A-15



TE Part # 2-1437167-9
FSP-23A-18



TE Part # 4-1437167-0
FSP-23A-4



TE Part # 2-1437167-7
FSP-23A-16

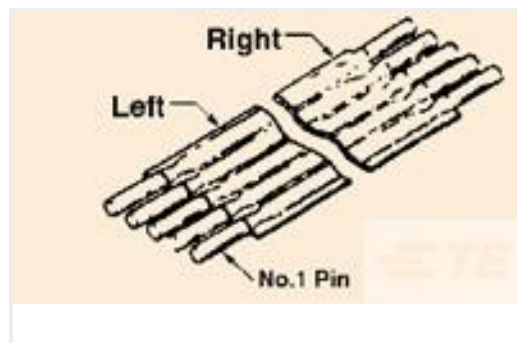

TE Part # 4-1437167-5
FSP-23A-9

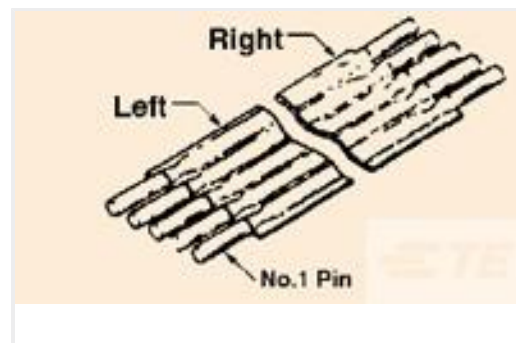

TE Part # 9-1437167-3
FSP-24A-3

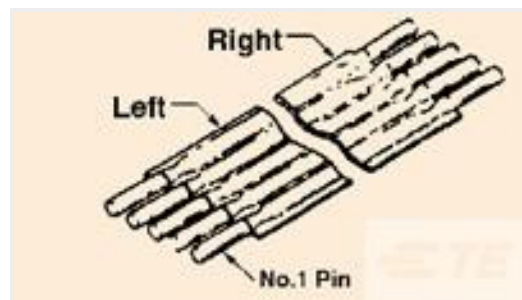

TE Part # 3-1437167-7
FSP-23A-26

Customers Also Bought



TE Part #640583-1
06P UMNL HDR ASSY R/A 94VO

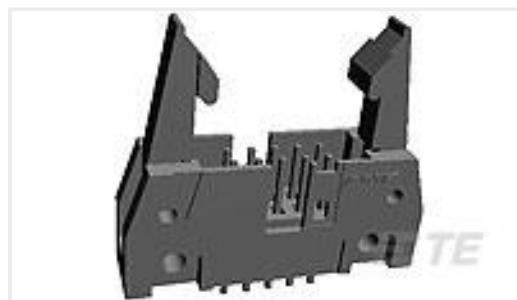

TE Part #5499922-3
A/L UNIV HDR 16P VERT LAT



TE Part #1-770872-0
02P MINI UMNL HDR ASSY SN



TE Part #1734035-2
MINI USB, TYPE B, R/A, SMT

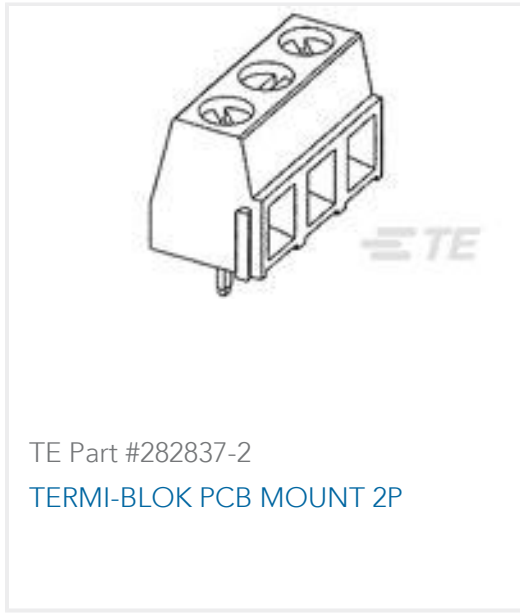

Documents

Product Drawings

[FSP-24A-10](#)

English

Product Specifications

[Product Specification](#)

English

Agency Approvals

[UL Report](#)

English