



CM-SCE-TP

TE Internal #: 6622650001

Military, -55 – 135 °C [-67 – 275 °F], Yellow, CM-SCE-TP, Printable

Tags

[View on TE.com >](#)

Identification & Labeling > Printable Tags



Printable Tag Grade: **Military**

Operating Temperature Range: **-55 – 135 °C [-67 – 275 °F]**

Primary Product Color: **Yellow**

EU RoHS Compliance: **Compliant**

EU ELV Compliance: **Compliant**

Features

Mechanical Attachment

Number of Tie-Wrap Holes	6
--------------------------	---

Printer/Label Features

Printer Technology	Dot Matrix
--------------------	------------

Dimensions

Product Length	50.8 mm[1.8 in]
----------------	-----------------

Product Height	12.7 mm[.6 in]
----------------	----------------

Packaging Features

Packaging Quantity	250
--------------------	-----

Product Type Features

Printable Tag Grade	Military
---------------------	----------

Usage Conditions

Operating Temperature Range	-55 – 135 °C[-67 – 275 °F]
-----------------------------	----------------------------

Body Features

Primary Product Color	Yellow
-----------------------	--------

Other

EU RoHS Compliance	Compliant
--------------------	-----------

EU ELV Compliance	Compliant
-------------------	-----------



Product Compliance

For compliance documentation, visit the product page on [TE.com](https://www.te.com)>

EU RoHS Directive 2011/65/EU	Compliant
EU ELV Directive 2000/53/EC	Compliant
China RoHS 2 Directive MIIT Order No 32, 2016	No Restricted Materials Above Threshold
EU REACH Regulation (EC) No. 1907/2006	Current ECHA Candidate List: JUNE 2024 (241) Candidate List Declared Against: JUNE 2024 (241) Does not contain REACH SVHC
Halogen Content	Not Low Halogen - contains Br or Cl > 900 ppm.
Solder Process Capability	Not applicable for solder process capability

Product Compliance Disclaimer

This information is provided based on reasonable inquiry of our suppliers and represents our current actual knowledge based on the information they provided. This information is subject to change. The part numbers that TE has identified as EU RoHS compliant have a maximum concentration of 0.1% by weight in homogenous materials for lead, hexavalent chromium, mercury, PBB, PBDE, DBP, BBP, DEHP, DIBP, and 0.01% for cadmium, or qualify for an exemption to these limits as defined in the Annexes of Directive 2011/65/EU (RoHS2). Finished electrical and electronic equipment products will be CE marked as required by Directive 2011/65/EU. Components may not be CE marked. Additionally, the part numbers that TE has identified as EU ELV compliant have a maximum concentration of 0.1% by weight in homogenous materials for lead, hexavalent chromium, and mercury, and 0.01% for cadmium, or qualify for an exemption to these limits as defined in the Annexes of Directive 2000/53/EC (ELV). Regarding the REACH Regulation, the information TE provides on SVHC in articles for this part number is based on the latest European Chemicals Agency (ECHA) 'Guidance on requirements for substances in articles' posted at this URL: <https://echa.europa.eu/guidance-documents/guidance-on-reach>

Compatible Parts

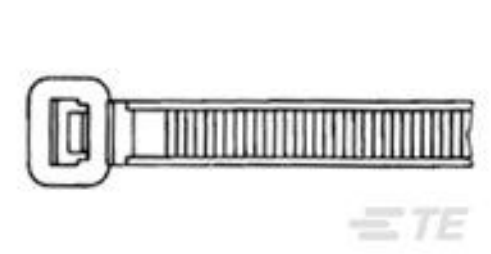
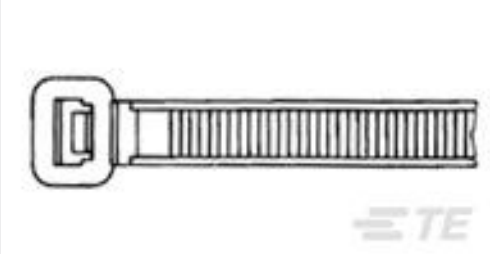
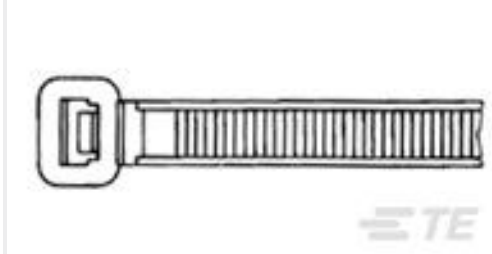
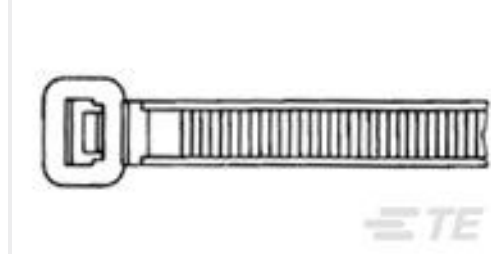
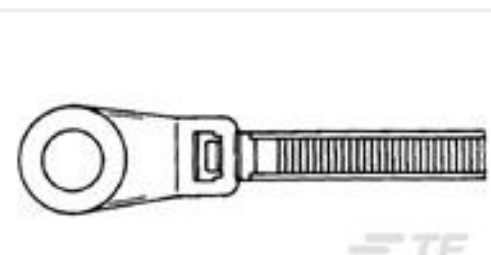
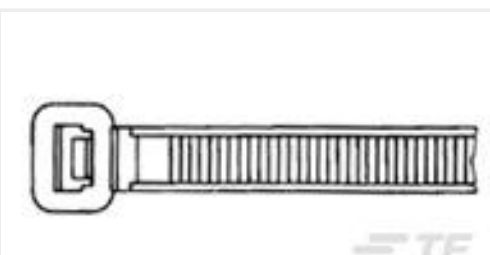
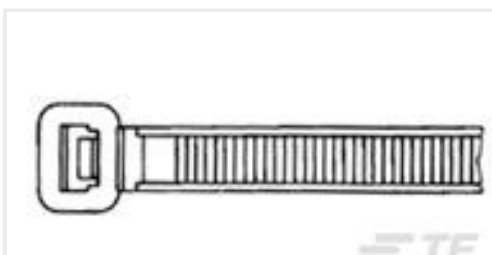
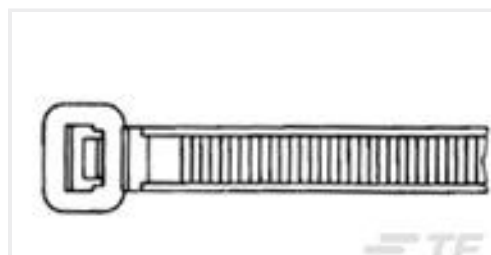
 <p>TE Part # 2-160971-2 FOAC CABLE TY BLACK 140X3.6</p>	 <p>TE Part # 4-160996-2 CABLE TY 200X3.6 BLA</p>	 <p>TE Part # 4-160968-1 CABLE TY 134X2.6 NAT</p>	 <p>TE Part # 2-160975-1 CABLE TY 200X4.8 NAT</p>
 <p>TE Part # 2-100715-1 CABLE TY 150X3,6NAT</p>	 <p>TE Part # 4-160975-1 CABLE TY 200X4.8 NAT</p>	 <p>TE Part # 4-160975-2 CABLE TY 200X4.8 BLA</p>	 <p>TE Part # 4-160968-2 CABLE TY 134X2.6 BLACK</p>

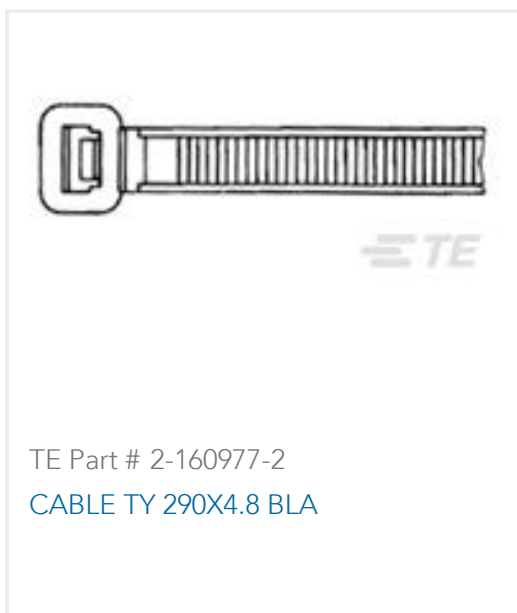
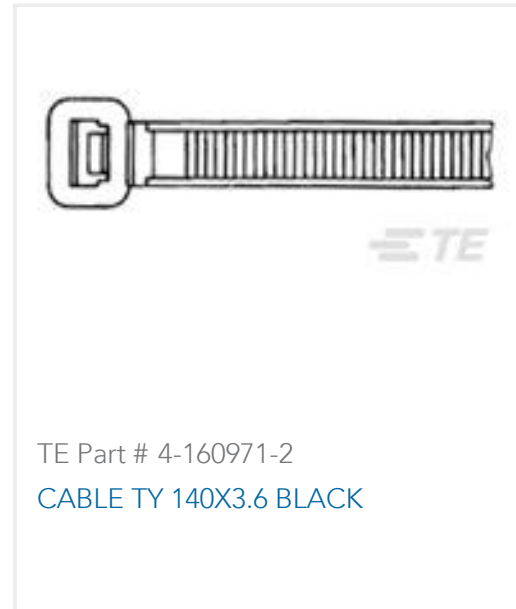
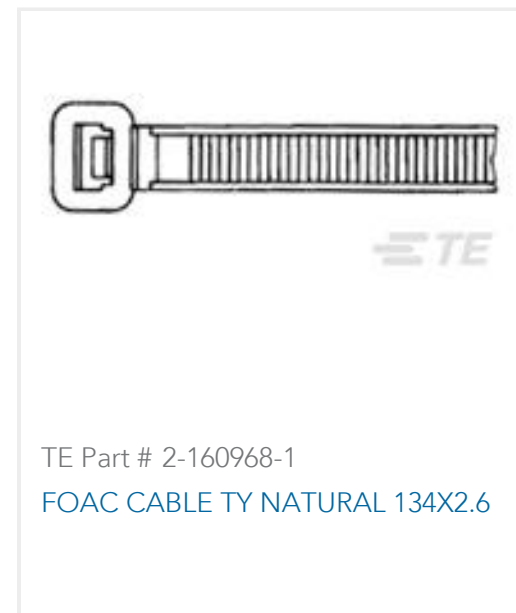
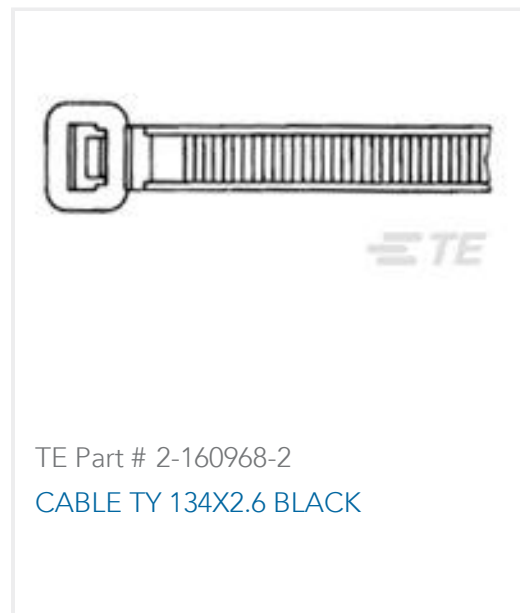
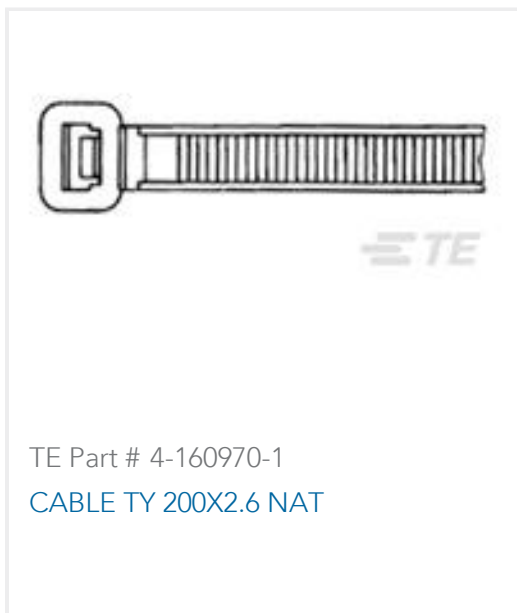

Also in the Series | CM-SCE-TP



Customers Also Bought

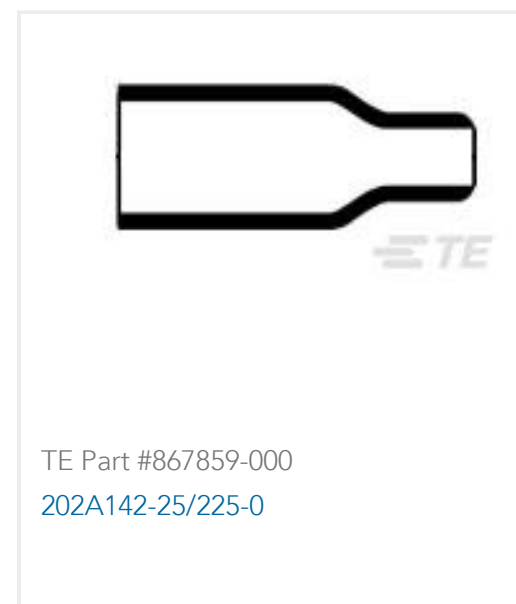
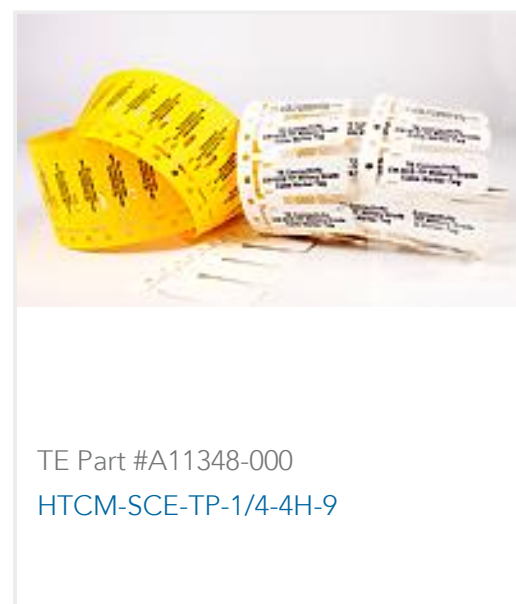



TE Part #5747099-5
CABLE CLAMP KIT,SZ 2



TE Part #695055-000
W-095-02



TE Part #4554650001
TMS-SCE-1K-1/8-2.0-9

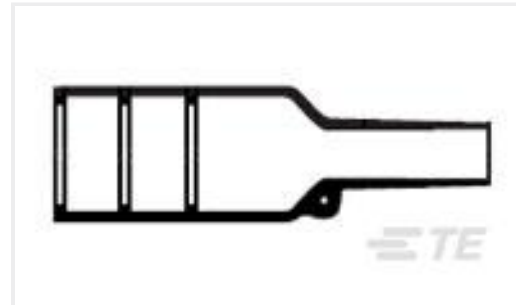

TE Part #165938-000
202K121-25/86-0



TE Part #329047-000
210W321-25-0

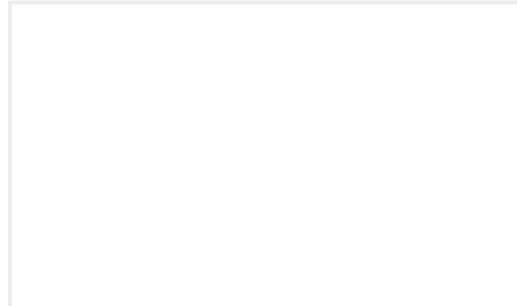

TE Part #5039304153
DR-25-1/2-0-CS-34034

Documents

Product Drawings

[CM-SCE-1/2-6H-4](#)

English

Datasheets & Catalog Pages

[CM-SCE Technical Datasheet](#)

English

Product Specifications

[CABLE MARKER INSTALLATION GUIDE](#)

English

[Product Specification](#)

English