

# PMOS0SS3A ✓ ACTIVE

Corcom | Corcom P

TE Internal #: 6609941-5

Power Entry (Filtered/Unfiltered), Single AC Input, DPST, Filter Shield, Vertical, 3 A, .187" FASTON Output, Corcom P, Power Entry Modules

[View on TE.com >](#)



EMI & EMC Solutions > EMI Filters > Power Entry Modules > CORCOM P SERIES MULTI-FUNCTION INLET FIL

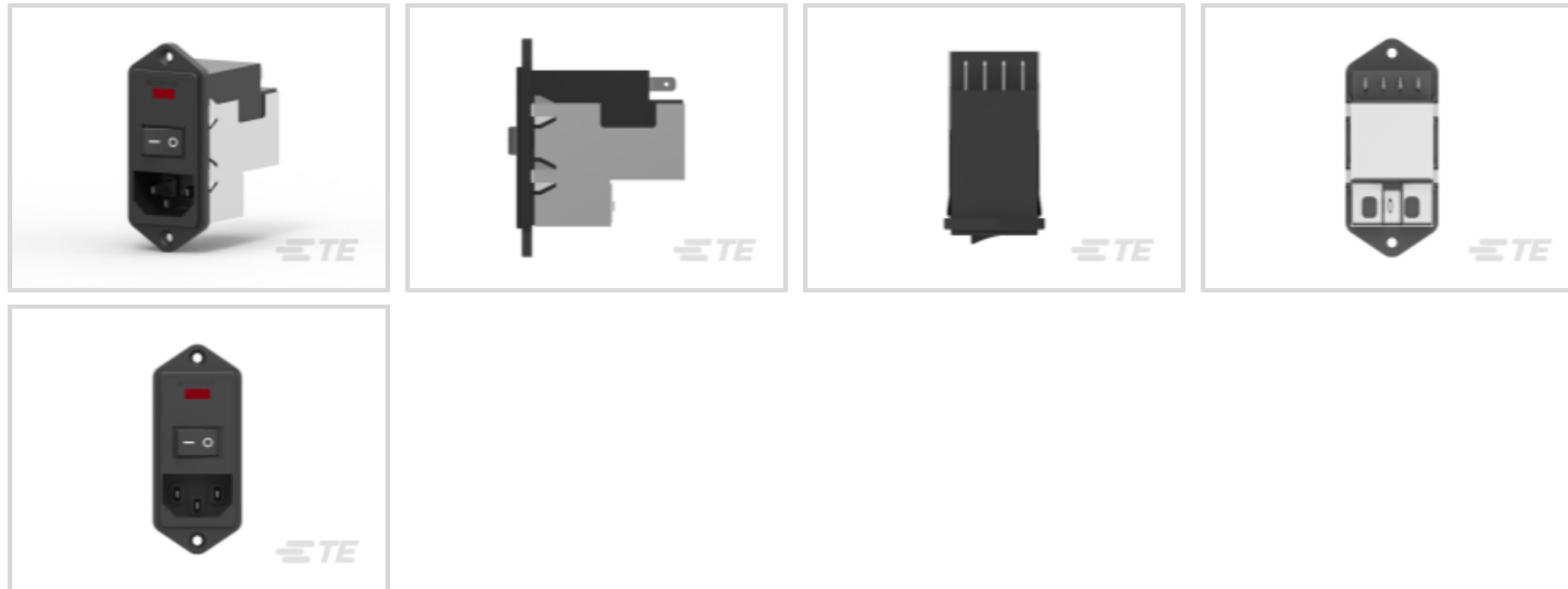

Filter Type: **Power Entry (Filtered/Unfiltered)**

Input Voltage Selection: **Single AC**

Filter Switch Type: **DPST**

Filter Shield Type: **Filter Shield**

Product Orientation: **Vertical**

[All CORCOM P SERIES MULTI-FUNCTION INLET FIL \(261\)](#)

## Features

### Mechanical Attachment

Panel Mount Feature Type	Flange
--------------------------	--------

### Dimensions

Panel Thickness (Recommended)	.79 – 2 mm [.031 – .079 in]
-------------------------------	-----------------------------

### Usage Conditions

Operating Temperature Range	-10 – 40 °C
-----------------------------	-------------

### Configuration Features

Extender Options	None
Fuse Options	Single

### Product Type Features

Ground Choke Option	No
Level Of Filtering	Inductor & Capacitor
Filter Type	Power Entry (Filtered/Unfiltered)



Filter Switch Type	DPST
Output Termination Type	.187" FASTON
Filtering Requirements	Filtered
Filter Connector Type	IEC 60320-1 C-14

### Electrical Characteristics

Input Voltage Selection	Single AC
Leakage Current (Max) (120VAC, 60Hz)	2 $\mu$ A
Leakage Current (Max) (250VAC, 50Hz)	5 $\mu$ A
Current Rating	3 A
Operating Voltage	115 VAC, 230 VAC

### Body Features

Filter Shield Type	Filter Shield
Product Orientation	Vertical

### Other

EU RoHS Compliance	Compliant
EU ELV Compliance	Compliant

### Product Compliance

[For compliance documentation, visit the product page on TE.com>](#)

EU RoHS Directive 2011/65/EU	Compliant
EU ELV Directive 2000/53/EC	Compliant
China RoHS 2 Directive MIIT Order No 32, 2016	No Restricted Materials Above Threshold
EU REACH Regulation (EC) No. 1907/2006	Current ECHA Candidate List: JUNE 2024 (241) Candidate List Declared Against: JUNE 2024 (241) Does not contain REACH SVHC
Halogen Content	Not Low Halogen - contains Br or Cl > 900 ppm.
Solder Process Capability	Not applicable for solder process capability

#### Product Compliance Disclaimer

This information is provided based on reasonable inquiry of our suppliers and represents our current actual knowledge based on the information they provided. This information is subject to change. The part numbers that TE has identified as EU RoHS compliant have a maximum concentration of 0.1% by weight in homogenous materials for lead, hexavalent chromium, mercury, PBB, PBDE, DBP, BBP, DEHP, DIBP, and 0.01% for cadmium, or qualify for an exemption to these limits as defined in the Annexes of Directive 2011/65/EU (RoHS2). Finished electrical and electronic equipment products will be CE marked as required by Directive 2011/65/EU. Components may not be CE marked. Additionally, the part

numbers that TE has identified as EU ELV compliant have a maximum concentration of 0.1% by weight in homogenous materials for lead, hexavalent chromium, and mercury, and 0.01% for cadmium, or qualify for an exemption to these limits as defined in the Annexes of Directive 2000/53/EC (ELV). Regarding the REACH Regulation, the information TE provides on SVHC in articles for this part number is based on the latest European Chemicals Agency (ECHA) 'Guidance on requirements for substances in articles' posted at this URL: <https://echa.europa.eu/guidance-documents/guidance-on-reach>

## Compatible Parts

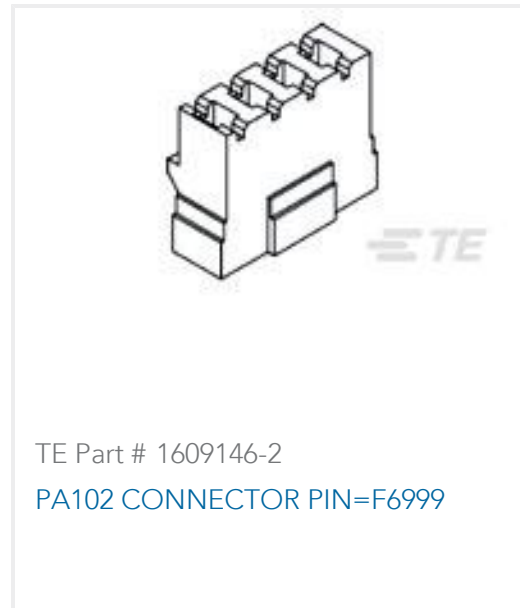

## Also in the Series | Corcom P

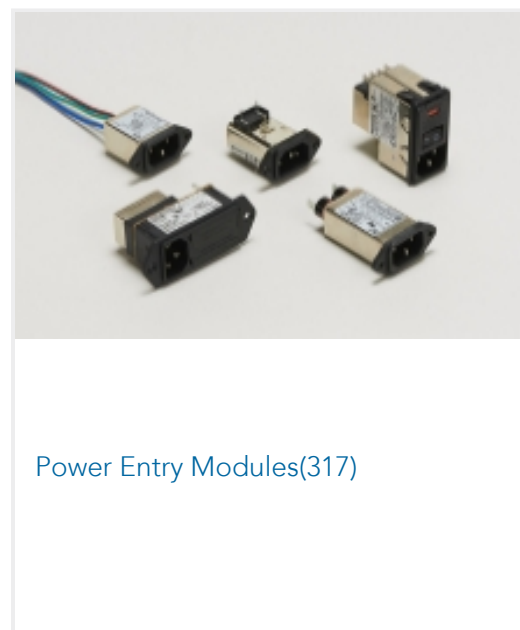
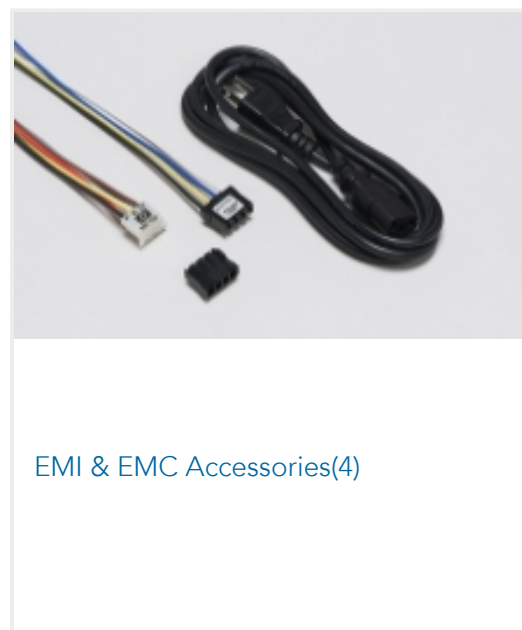

## Customers Also Bought

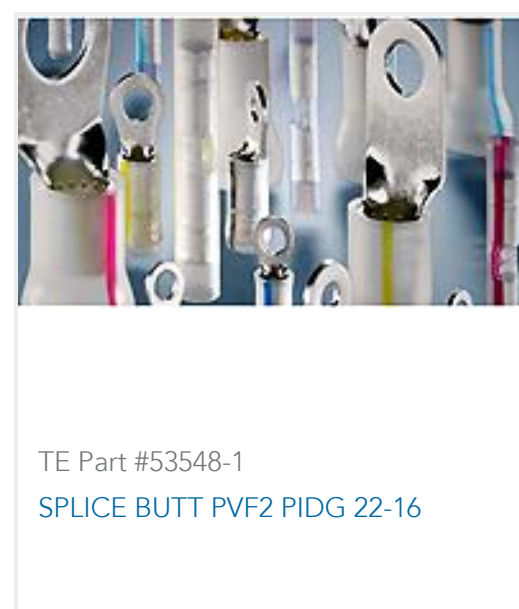
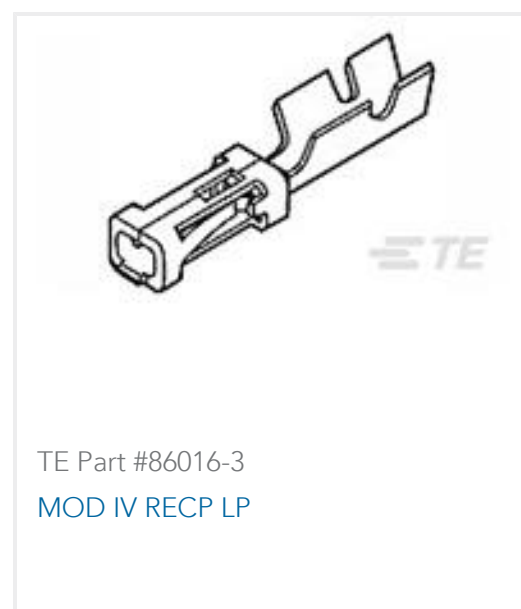
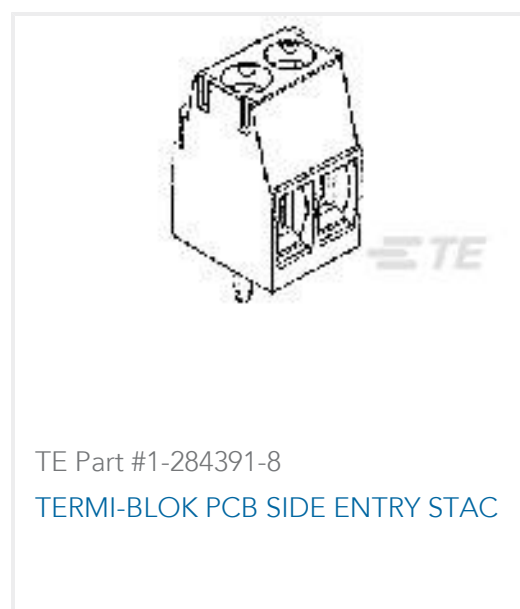

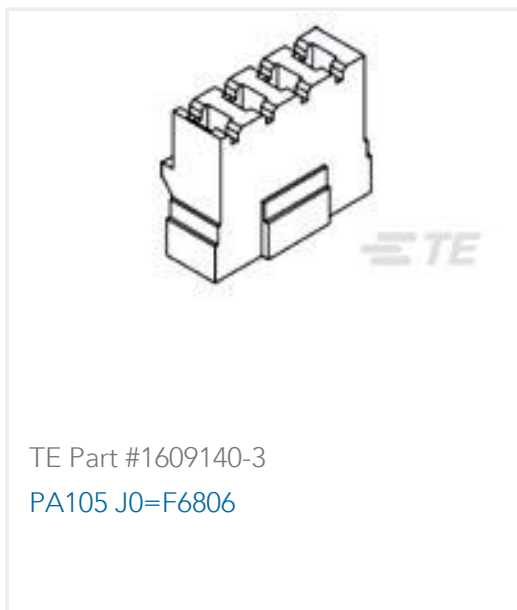

## Documents

### Product Drawings

[PMOS0SS3A=C3419](#)

English

### CAD Files

Customer View Model

[ENG\\_CVM\\_6609941-5\\_A.3d\\_igs.zip](#)

English

Customer View Model

[ENG\\_CVM\\_6609941-5\\_A.3d\\_stp.zip](#)

English

Customer View Model

[ENG\\_CVM\\_6609941-5\\_A.2d\\_dxf.zip](#)

English

### 3D PDF

English

Customer View Model

[ENG\\_CVM\\_CVM\\_6609941-5\\_O.3d\\_igs.zip](#)

English

Customer View Model

[ENG\\_CVM\\_CVM\\_6609941-5\\_O.3d\\_stp.zip](#)

English

Customer View Model

[ENG\\_CVM\\_CVM\\_6609941-5\\_O.2d\\_dxf.zip](#)

English

### 3D PDF

3D

By downloading the CAD file I accept and agree to the [Terms and Conditions](#) of use.

### Datasheets & Catalog Pages

[Corcom Combined Selector Charts](#)

English

[1-1654250-1\\_CORCOM\\_EMI\\_RFI\\_QRG](#)

English

PMOS0SS3A

Power Entry (Filtered/Unfiltered), Single AC Input, DPST, Filter Shield, Vertical, 3 A, .  
187" FASTON Output, Corcom P, Power Entry Modules

