



CM-SCE-TP

TE Internal #: 6485470001

TE Internal Description: CM-SCE-1/4-4H-9

[View on TE.com >](#)



Product Compliance

[For compliance documentation, visit the product page on TE.com>](#)

EU RoHS Directive 2011/65/EU	Compliant
EU ELV Directive 2000/53/EC	Compliant
China RoHS 2 Directive MIIT Order No 32, 2016	No Restricted Materials Above Threshold
EU REACH Regulation (EC) No. 1907/2006	Current ECHA Candidate List: JUNE 2024 (241) Candidate List Declared Against: JUNE 2024 (241) Does not contain REACH SVHC
Halogen Content	Not Low Halogen - contains Br or Cl > 900 ppm.
Solder Process Capability	Not applicable for solder process capability

Product Compliance Disclaimer

This information is provided based on reasonable inquiry of our suppliers and represents our current actual knowledge based on the information they provided. This information is subject to change. The part numbers that TE has identified as EU RoHS compliant have a maximum concentration of 0.1% by weight in homogenous materials for lead, hexavalent chromium, mercury, PBB, PBDE, DBP, BBP, DEHP, DIBP, and 0.01% for cadmium, or qualify for an exemption to these limits as defined in the Annexes of Directive 2011/65/EU (RoHS2). Finished electrical and electronic equipment products will be CE marked as required by Directive 2011/65/EU. Components may not be CE marked. Additionally, the part numbers that TE has identified as EU ELV compliant have a maximum concentration of 0.1% by weight in homogenous materials for lead, hexavalent chromium, and mercury, and 0.01% for cadmium, or qualify for an exemption to these limits as defined in the Annexes of Directive 2000/53/EC (ELV). Regarding the REACH Regulation, the information TE provides on SVHC in articles for this part number is based on the latest European Chemicals Agency (ECHA) 'Guidance on requirements for substances in articles' posted at this URL: <https://echa.europa.eu/guidance-documents/guidance-on-reach>

Compatible Parts

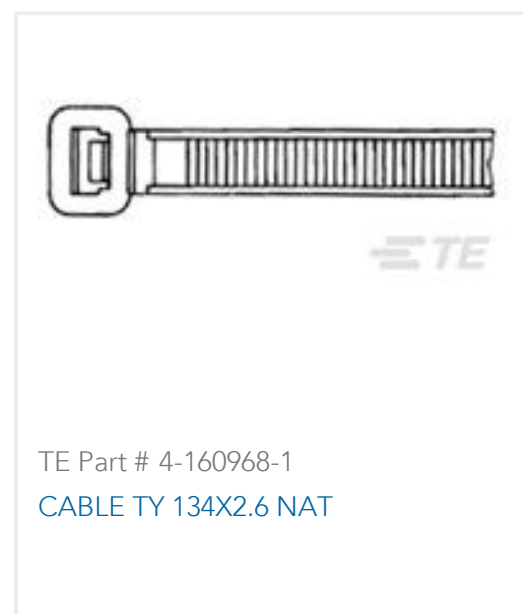
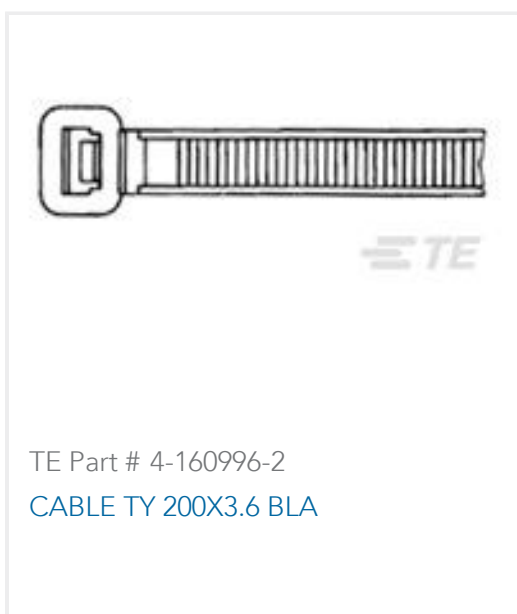
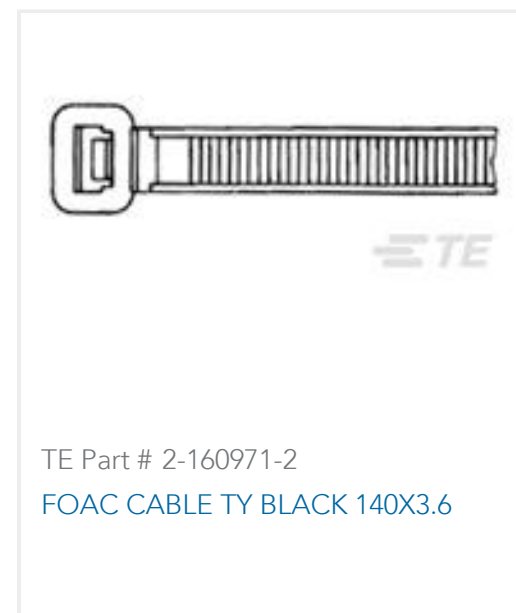
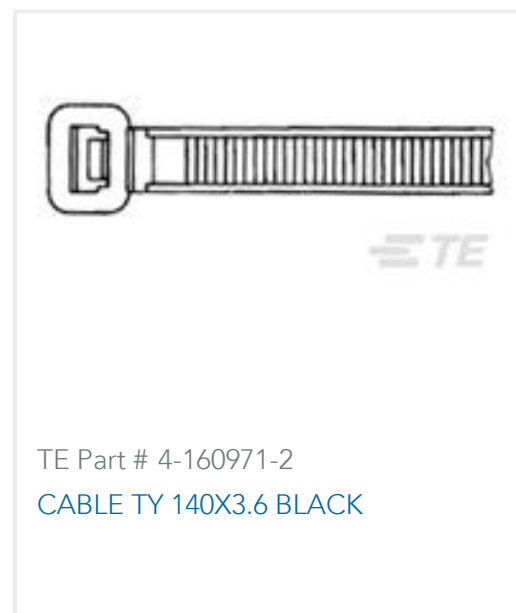
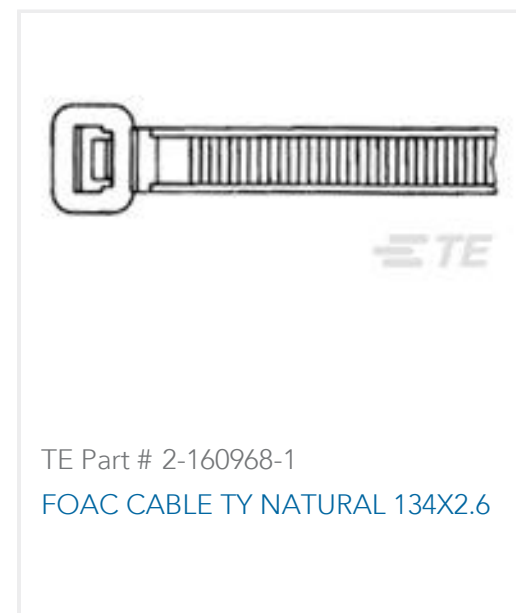
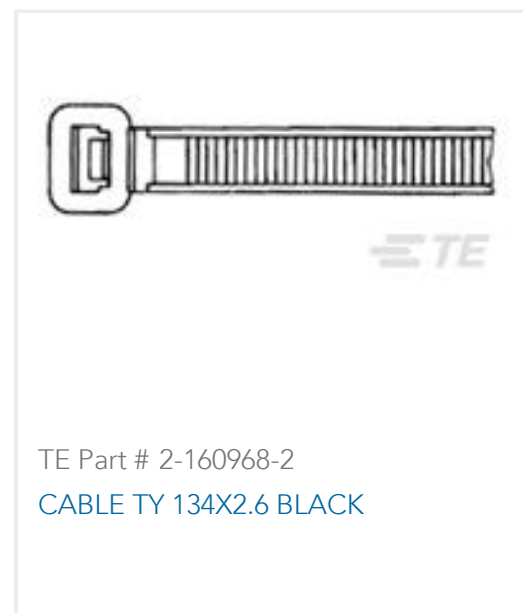
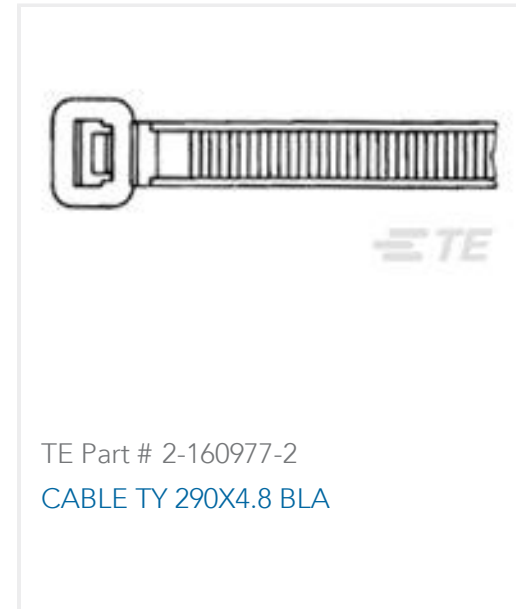
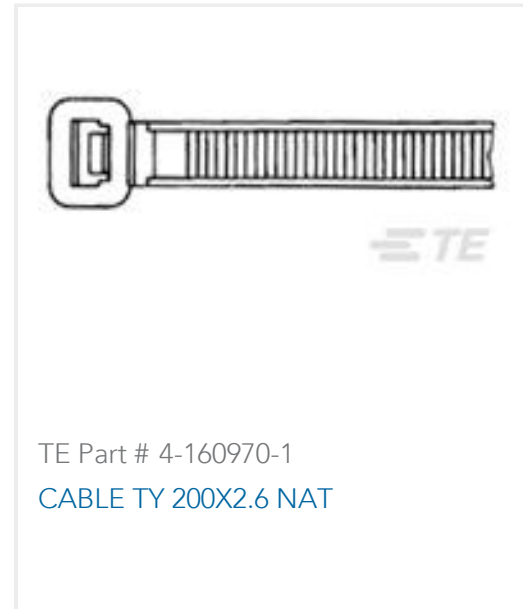
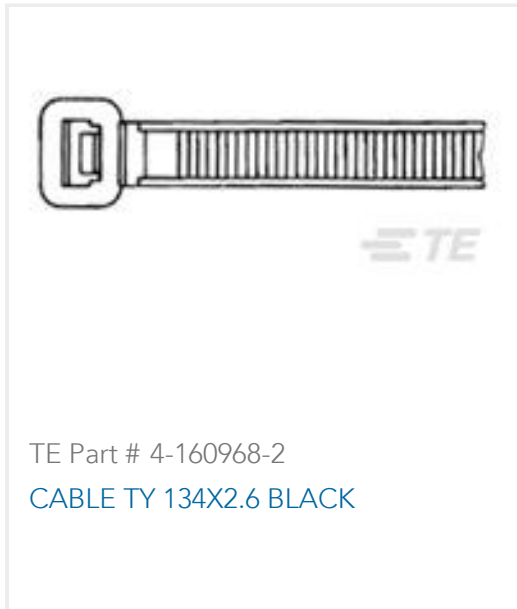
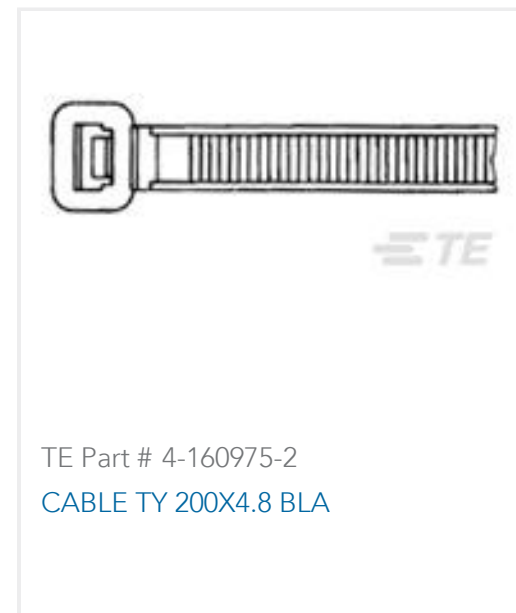
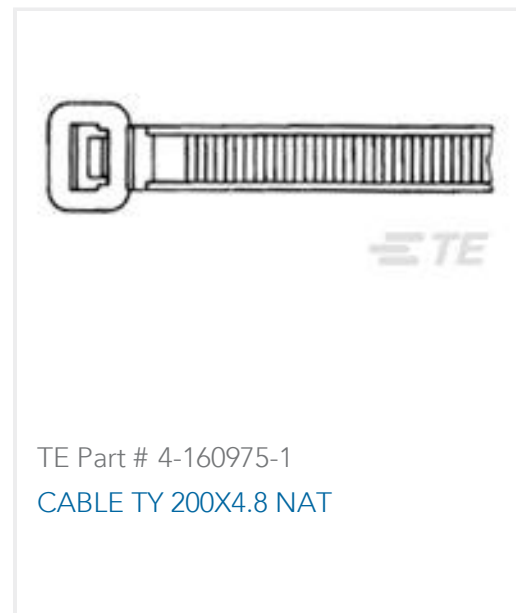
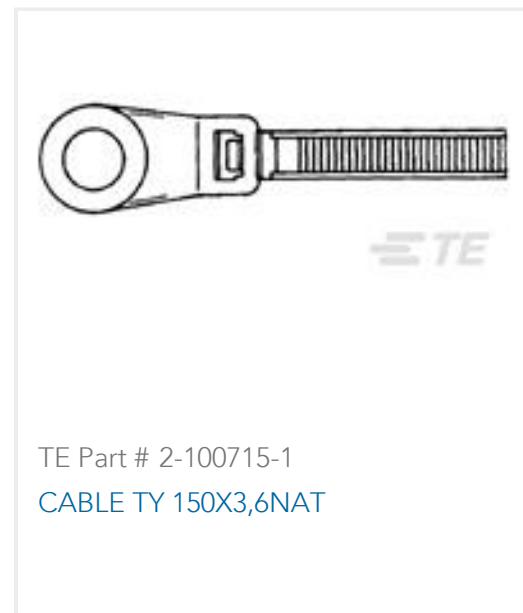
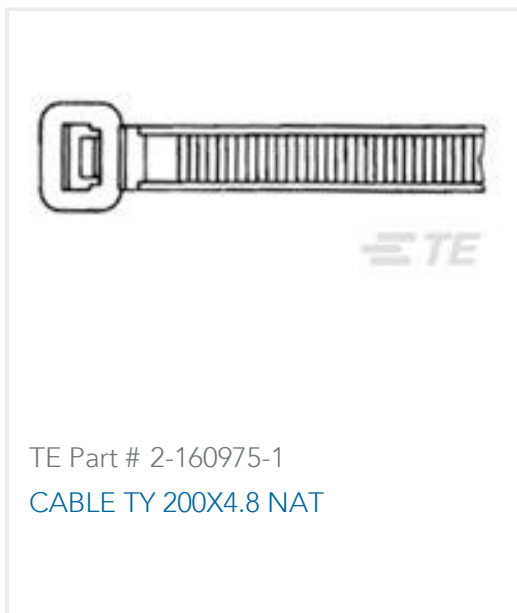

Also in the Series | [CM-SCE-TP](#)



Printable Tags(12)

Customers Also Bought

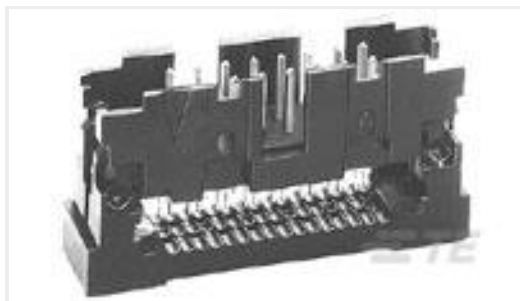

TE Part #111446-4
020 UNIV I/O 30DP NO EARS



TE Part #1-1609968-6
KEP 36A 1S HIGH PLUS SP WYE
440VAC



TE Part #0076930001
CM-SCE-1/2-4H-9



TE Part #821046-000
562A032-4/42-0

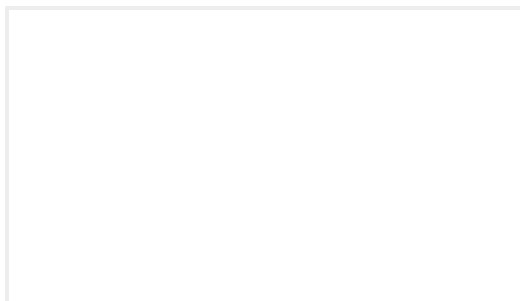

TE Part #YCTJ-3A-06C0160000
RAIL ASSY



TE Part #2-320569-6
TERMINAL,PIDG R IR 10 1/4

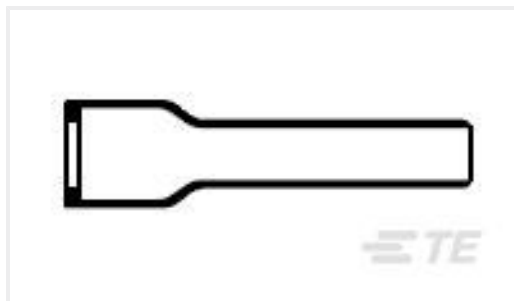

TE Part #808489-000
202D242-3-0



TE Part #CAT-HST-RNF100-BK
RNF-100-BK Heat Shrink Tubing



TE Part #3576550001
HTCM-SCE-1/4-4H-9

Documents

Datasheets & Catalog Pages

[CM-SCE Technical Datasheet](#)

English

Product Specifications

[CABLE MARKER INSTALLATION GUIDE](#)

English

[Product Specification](#)

English

