

61764-1 ✓ ACTIVE

TE Internal #: 61764-1

Closed Ring Tongue Terminal, 20 – 16 AWG, #6 / M3.5 Stud, 3.51 mm [.138 in] Stud Diameter, Open Barrel, Straight, Unplated Plating, Uninsulated

[View on TE.com >](#)



Terminals & Splices > Ring Terminals

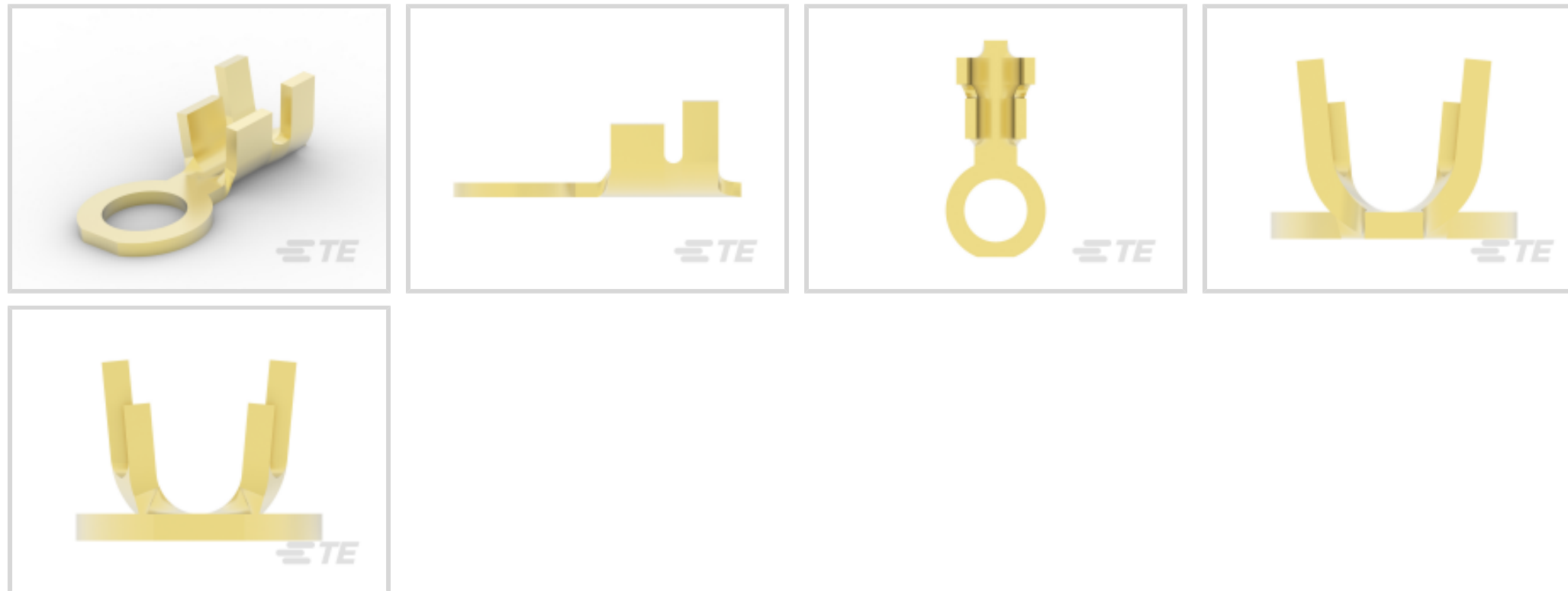

Ring Terminal Product Type: Closed Ring Tongue Terminal

Wire Size: 1021 – 2582 CMA

Stud Size: #6, M3.5

Features

Configuration Features

Number of Holes	1
-----------------	---

Mechanical Attachment

Wire Insulation Support	With
-------------------------	------

Industry Standards

Government Qualified Terminal	No
-------------------------------	----

Packaging Features

Packaging Quantity	20000
--------------------	-------

Packaging Method	Strip/Reel
------------------	------------

Contact Features

Contact Base Material	Brass
-----------------------	-------

Barrel Type	Open
-------------	------

Terminal Orientation	Straight
----------------------	----------

Terminal Plating Material	Unplated
---------------------------	----------

Contact Underplating Material	None
-------------------------------	------

Dimensions



	.09 in
Wire Size	1021 – 2582 CMA
Stud Diameter	3.51 mm [.138 in]
Tongue Thickness	.76 mm [.03 in]
Product Length	11.68 mm [.46 in]
Barrel Inside Diameter	2.92 mm, 2.03 mm [.08 in] [.115 in]
Compatible Insulation Diameter (Max)	3.05 mm [.12 in]
Compatible Insulation Diameter Range	2.29 – 3.05 mm [.09 – .12 in]

Product Type Features

Shape Description	Circular/Oval
Ring Terminal Product Type	Closed Ring Tongue Terminal
Stud Size	#6, M3.5
Sealable	No
Compatible With Discrete Wire Type	Stranded
Wire Insulation Support Retention Type	Insulation Support

Usage Conditions

Insulation Option	Uninsulated
Operating Temperature Range	-40 – 110 °C [-40 – 230 °F]

Operation/Application

Compatible With Wire Base Material	Copper
------------------------------------	--------

Other

EU RoHS Compliance	Compliant
EU ELV Compliance	Compliant

Product Compliance

[For compliance documentation, visit the product page on TE.com>](#)











EU RoHS Directive 2011/65/EU	Compliant
EU ELV Directive 2000/53/EC	Compliant
China RoHS 2 Directive MIIT Order No 32, 2016	No Restricted Materials Above Threshold
EU REACH Regulation (EC) No. 1907/2006	Current ECHA Candidate List: JUNE 2024 (241) Candidate List Declared Against: JUNE 2024 (241) Does not contain REACH SVHC

Halogen Content	Low Halogen - Br, Cl, F, I < 900 ppm per homogenous material. Also BFR/CFR/PVC Free
Solder Process Capability	Not applicable for solder process capability

Product Compliance Disclaimer

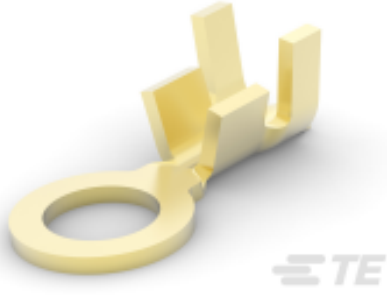
This information is provided based on reasonable inquiry of our suppliers and represents our current actual knowledge based on the information they provided. This information is subject to change. The part numbers that TE has identified as EU RoHS compliant have a maximum concentration of 0.1% by weight in homogenous materials for lead, hexavalent chromium, mercury, PBB, PBDE, DBP, BBP, DEHP, DIBP, and 0.01% for cadmium, or qualify for an exemption to these limits as defined in the Annexes of Directive 2011/65/EU (RoHS2). Finished electrical and electronic equipment products will be CE marked as required by Directive 2011/65/EU. Components may not be CE marked. Additionally, the part numbers that TE has identified as EU ELV compliant have a maximum concentration of 0.1% by weight in homogenous materials for lead, hexavalent chromium, and mercury, and 0.01% for cadmium, or qualify for an exemption to these limits as defined in the Annexes of Directive 2000/53/EC (ELV). Regarding the REACH Regulation, the information TE provides on SVHC in articles for this part number is based on the latest European Chemicals Agency (ECHA) 'Guidance on requirements for substances in articles' posted at this URL: <https://echa.europa.eu/guidance-documents/guidance-on-reach>

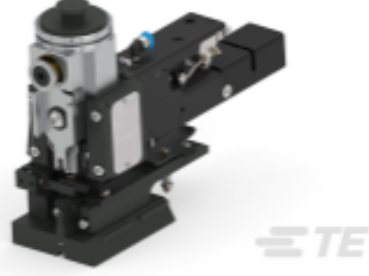
Compatible Parts

 <p>TE Part # 160101-7 RING TONGUE 20-16 AWG 0.0253 BR</p>	 <p>TE Part # 4150091-2 OCEAN-2.0-APPLICATOR-E-120F1500-REA</p>	 <p>KIT REPRESENTATION ONLY</p> <p>TE Part # 7-4150091-7 OCEAN_2.0_SPARE_PART_KIT-120F1500</p>	 <p>TE Part # 626235-1 TERMINAL RING TONG</p>
 <p>TE Part # 42721-1 RING TONGUE CRIMP 20-16 AWG BR</p>	 <p>TE Part # 60389-1 SPADE CRIMP 20-16 AWG BR</p>	 <p>TE Part # 41472 RING TERMINAL 20-16 AWG TPBR</p>	 <p>TE Part # 41471 RING IS 20-16 .156 .025BR</p>
 <p>TE Part # 60700-3 RING CRIMP 20-16 AWG BR</p>	 <p>TE Part # 4150091-1 OCEAN-2.0-APPLICATOR-E-120F1500-REM</p>	 <p>TE Part # 60700-2 RING CRIMP 20-16 AWG TPBR</p>	 <p>TE Part # 160101-1 RING TONGUE 20-16 AWG 0.0253 BR</p>



Customers Also Bought

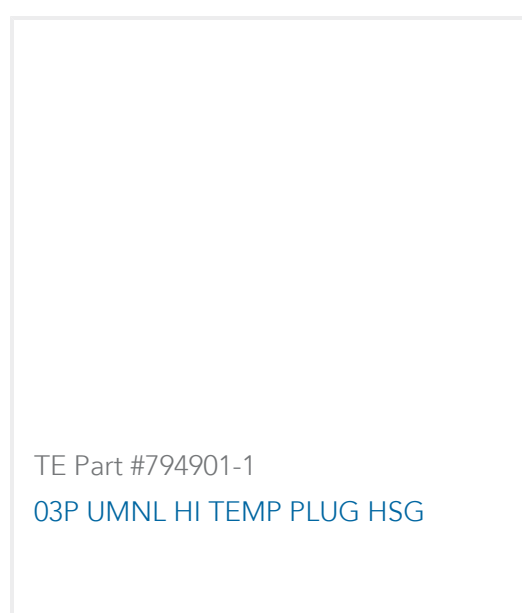
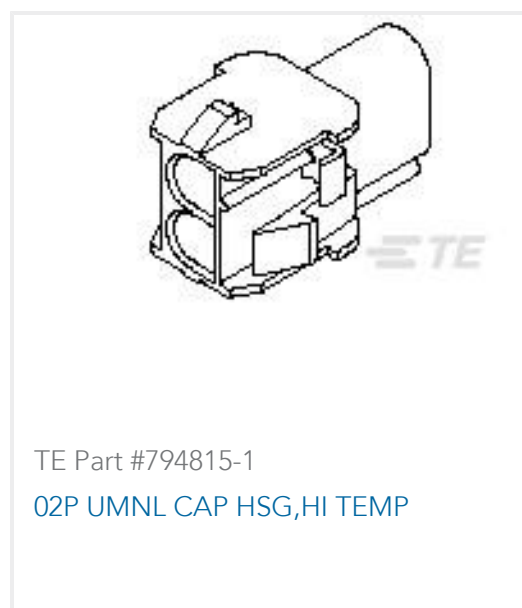

Documents

Product Drawings

[RING CRIMP 20-16 AWG BR](#)

English

CAD Files

[3D PDF](#)

3D

[Customer View Model](#)

[ENG_CVM_CVM_61764-1_E_c-61764-1-e.2d_dxf.zip](#)



English

Customer View Model

[ENG_CVM_CVM_61764-1_E_c-61764-1-e.3d_igs.zip](#)

English

Customer View Model

[ENG_CVM_CVM_61764-1_E_c-61764-1-e.3d_stp.zip](#)

English

By downloading the CAD file I accept and agree to the [Terms and Conditions](#) of use.

Product Specifications

[Application Specification](#)

English