

60843-1 ✓ ACTIVE

MATE-N-LOK | Commercial MATE-N-LOK

TE Internal #: 60843-1

TE Internal Description: 2P CMNL COMM TAB PTPBR

[View on TE.com >](#)



Product Compliance

[For compliance documentation, visit the product page on TE.com>](#)

EU RoHS Directive 2011/65/EU	Compliant
EU ELV Directive 2000/53/EC	Compliant
China RoHS 2 Directive MIIT Order No 32, 2016	No Restricted Materials Above Threshold
EU REACH Regulation (EC) No. 1907/2006	Current ECHA Candidate List: JUNE 2024 (241) Candidate List Declared Against: JUNE 2024 (241) Does not contain REACH SVHC
Halogen Content	Low Halogen - Br, Cl, F, I < 900 ppm per homogenous material. Also BFR/CFR/PVC Free
Solder Process Capability	Not applicable for solder process capability

Product Compliance Disclaimer

This information is provided based on reasonable inquiry of our suppliers and represents our current actual knowledge based on the information they provided. This information is subject to change. The part numbers that TE has identified as EU RoHS compliant have a maximum concentration of 0.1% by weight in homogenous materials for lead, hexavalent chromium, mercury, PBB, PBDE, DBP, BBP, DEHP, DIBP, and 0.01% for cadmium, or qualify for an exemption to these limits as defined in the Annexes of Directive 2011/65/EU (RoHS2). Finished electrical and electronic equipment products will be CE marked as required by Directive 2011/65/EU. Components may not be CE marked. Additionally, the part numbers that TE has identified as EU ELV compliant have a maximum concentration of 0.1% by weight in homogenous materials for lead, hexavalent chromium, and mercury, and 0.01% for cadmium, or qualify for an exemption to these limits as defined in the Annexes of Directive 2000/53/EC (ELV). Regarding the REACH Regulation, the information TE provides on SVHC in articles for this part number is based on the latest European Chemicals Agency (ECHA) 'Guidance on requirements for substances in articles' posted at this URL: <https://echa.europa.eu/guidance-documents/guidance-on-reach>

Also in the Series | [Commercial MATE-N-LOK](#)

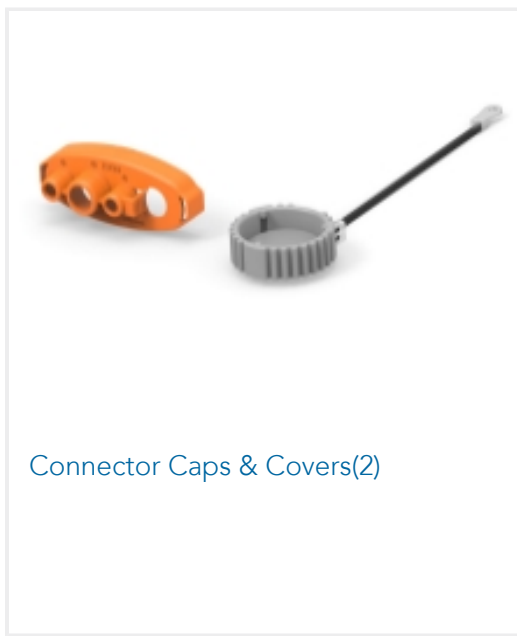

Connector Caps & Covers(2)

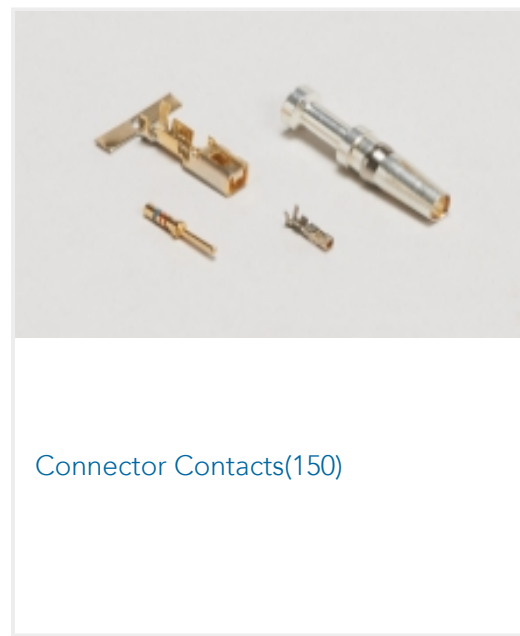

Connector Contacts(150)

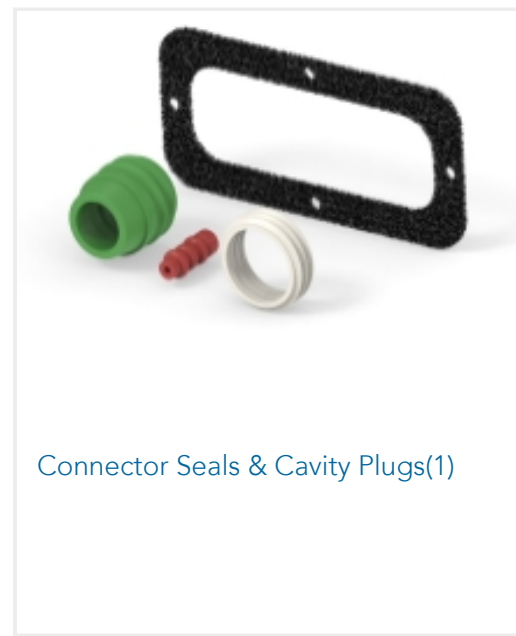

Connector Seals & Cavity Plugs(1)

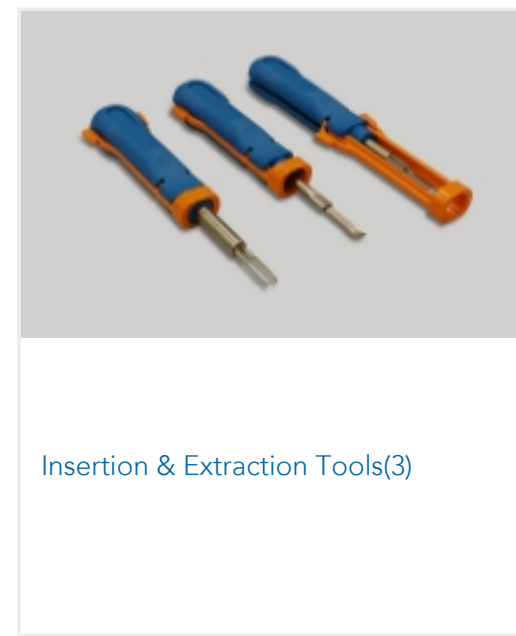

Insertion & Extraction Tools(3)



PCB Headers & Receptacles(56)

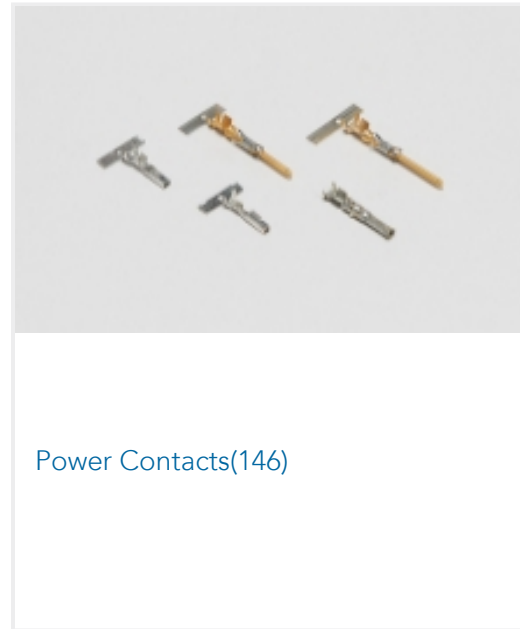

Power Contacts(146)

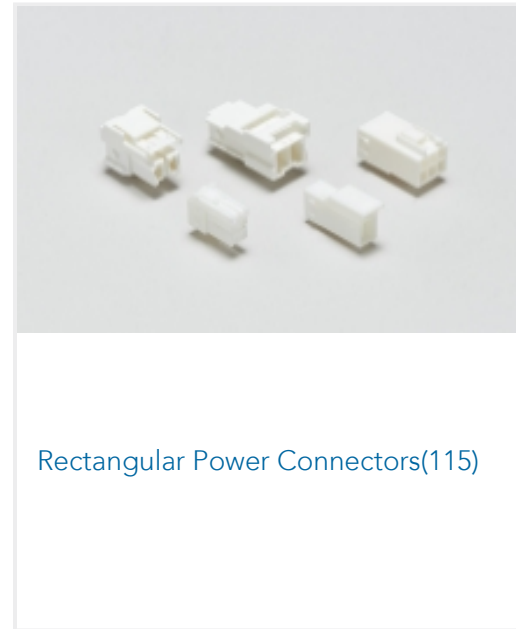

Rectangular Power Connectors(115)

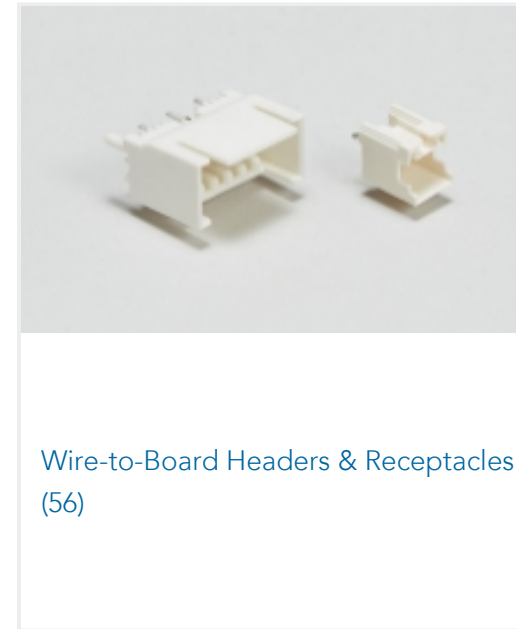

Wire-to-Board Headers & Receptacles (56)

Customers Also Bought



TE Part #2-380937-0
MR SPLT GROMET .312 DIA BLK LF



TE Part #346656-000
S01-04-R



TE Part #1-480273-0
06P CMNL PLUG HSG P/M NATL



TE Part #91514-1
CCII FASTON 250 REC 22-18 ASSY



TE Part #31884
PIDG R 22-16 COMM 22-18 MIL 10



TE Part #1-480305-0
03P CMNL CAP HSG F/H NATL

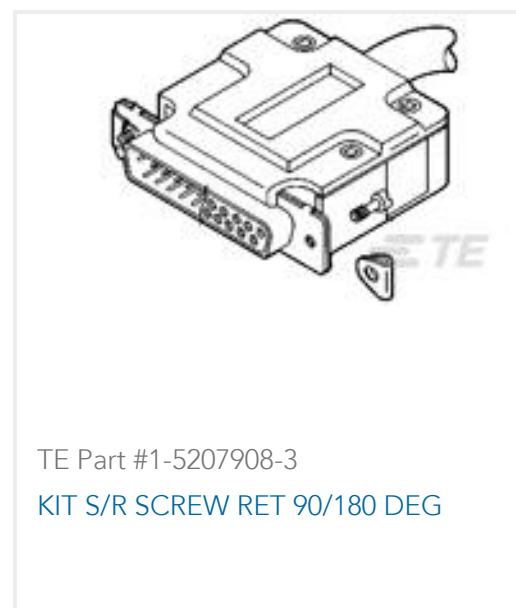

TE Part #1-5207908-3
KIT S/R SCREW RET 90/180 DEG



TE Part #1-480706-0
09P UMNL PLUG HSG NATL



TE Part #61116-5
CMNL PIN 24-18 AUNIBR



TE Part #1-480424-0
04P CMNL PLUG HSG F/H NATL

Documents



Product Drawings

2P CMNL COMM TAB PTPBR

English

CAD Files

Customer View Model

[ENG_CVM_60843-1_C.3d_igs.zip](#)

English

Customer View Model

[ENG_CVM_60843-1_C.3d_stp.zip](#)

English

Customer View Model

[ENG_CVM_60843-1_C.2d_dxf.zip](#)

English

3D PDF

English

By downloading the CAD file I accept and agree to the [Terms and Conditions](#) of use.

Datasheets & Catalog Pages

[SOFT_SHELL_PIN_SOCKET_CONNECTORS_STANDARD_DENSITY](#)

English

Instruction Sheets

[Instruction Sheet \(U.S.\)](#)

English