

Product Compliance

[For compliance documentation, visit the product page on TE.com>](#)

EU RoHS Directive 2011/65/EU	Compliant
EU ELV Directive 2000/53/EC	Compliant
China RoHS 2 Directive MIIT Order No 32, 2016	No Restricted Materials Above Threshold
EU REACH Regulation (EC) No. 1907/2006	Current ECHA Candidate List: JUNE 2024 (241) Candidate List Declared Against: JUNE 2024 (241) Does not contain REACH SVHC
Halogen Content	Not Low Halogen - contains Br or Cl > 900 ppm.
Solder Process Capability	Reflow solder capable to 260°C

Product Compliance Disclaimer

This information is provided based on reasonable inquiry of our suppliers and represents our current actual knowledge based on the information they provided. This information is subject to change. The part numbers that TE has identified as EU RoHS compliant have a maximum concentration of 0.1% by weight in homogenous materials for lead, hexavalent chromium, mercury, PBB, PBDE, DBP, BBP, DEHP, DIBP, and 0.01% for cadmium, or qualify for an exemption to these limits as defined in the Annexes of Directive 2011/65/EU (RoHS2). Finished electrical and electronic equipment products will be CE marked as required by Directive 2011/65/EU. Components may not be CE marked. Additionally, the part numbers that TE has identified as EU ELV compliant have a maximum concentration of 0.1% by weight in homogenous materials for lead, hexavalent chromium, and mercury, and 0.01% for cadmium, or qualify for an exemption to these limits as defined in the Annexes of Directive 2000/53/EC (ELV). Regarding the REACH Regulation, the information TE provides on SVHC in articles for this part number is based on the latest European Chemicals Agency (ECHA) 'Guidance on requirements for substances in articles' posted at this URL: <https://echa.europa.eu/guidance-documents/guidance-on-reach>

Compatible Parts



TE Part # 1-86479-6
08 MODII HDR DRRR UNSHRD .100

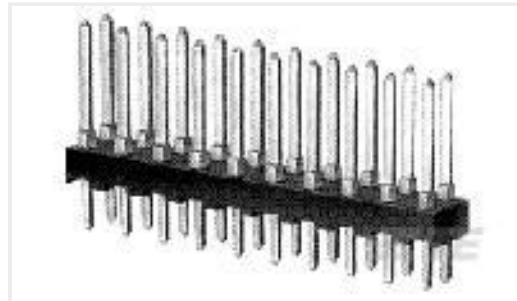

TE Part # 87215-1
08 MODII HDR DRST UNSHRD .100

Also in the Series | Modu Connector System

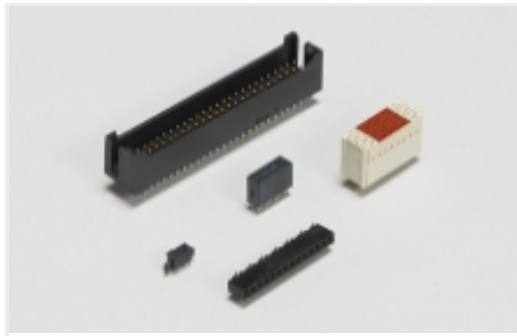

Board-to-Board Headers & Receptacles(814)

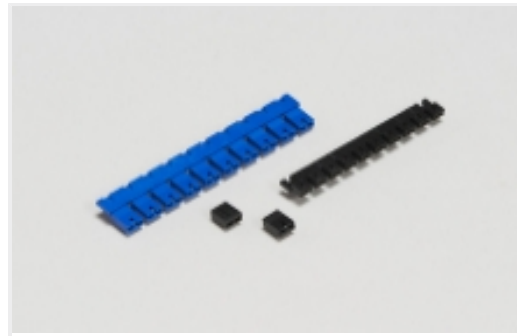

Board-to-Board Jumpers & Shunts(5)

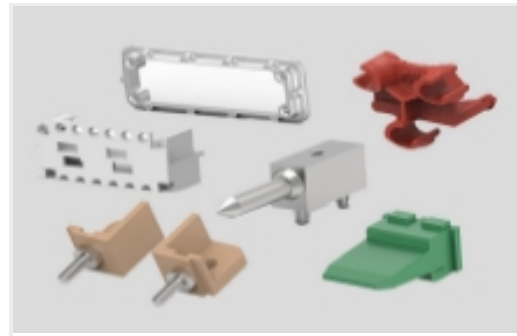

Connector Hardware(4)

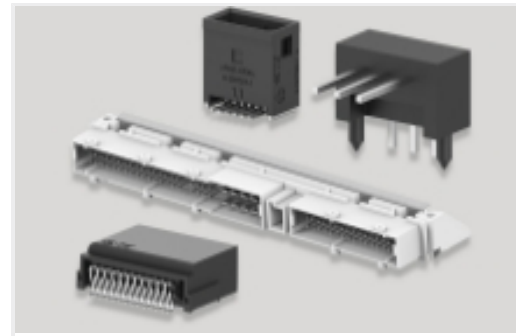

PCB Headers & Receptacles(814)

Customers Also Bought



TE Part #1617118-8
J1MAC-5XL = M39016/7-025L

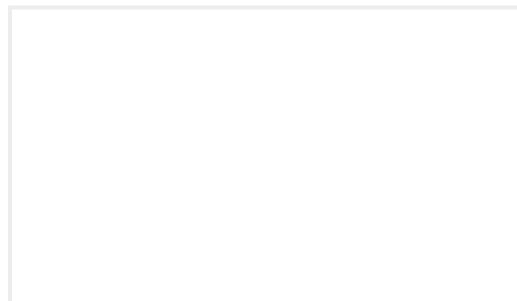

TE Part #RM54-106S
RECP ASSY

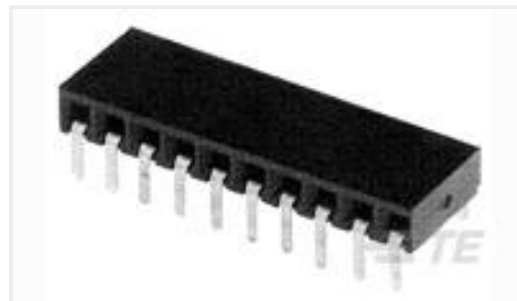

TE Part #1-216602-0
10P HV190 FEDERLEIS



TE Part #5569260-1
STK MJ ASSY,8POS,2X2,SHLD,CAT5



TE Part #1825190-7
DIP Shunt,8 pos

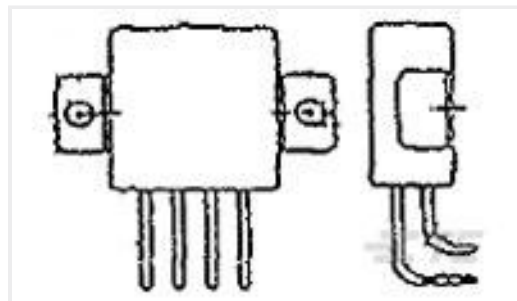

TE Part #5-1617758-3
FCB-205-0227M=M83536/2-027M



TE Part #1-770166-1
02P MINI UMNL ASSY VO SNAU LF



TE Part #87984-8
08 MODI BDMNT RCPT SR .156CL

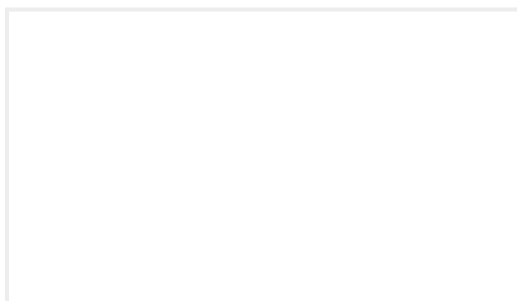

TE Part #1-1617037-8
HFW5A1201S501 = HFW5A RELAY

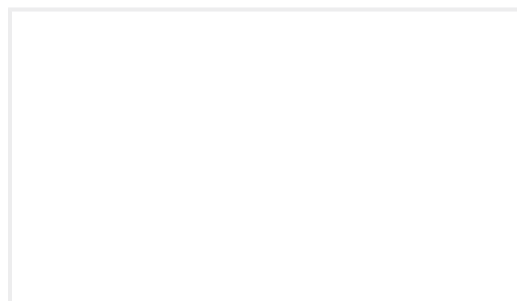

TE Part #923825-E
ERMEZT ADH ABC 9999 1 144 ***
ABDECKHA



Documents

Product Drawings

[08 MODII HORZ DR CE EESS .100](#)

English

CAD Files

[3D PDF](#)

English

Customer View Model

[ENG_CVM_6-535512-3_Y1.3d_stp.zip](#)

English

Customer View Model

[ENG_CVM_6-535512-3_Y1.3d_igs.zip](#)

English

Customer View Model

[ENG_CVM_6-535512-3_Y1.2d_dxf.zip](#)

English

By downloading the CAD file I accept and agree to the [Terms and Conditions](#) of use.

Product Specifications

[Application Specification](#)

English