

6-160449-6 ✓ ACTIVE

FASTIN-FASTON | FASTIN-FASTON 250

TE Internal #: 6-160449-6

Quick Disconnect Receptacle, 17 – 13 AWG, 1.03 – 2.62 mm² Wire, 6.35 mm [.25 in] Tab Width, Straight, Brass, Silver Plating, FASTIN-FASTON 250

[View on TE.com >](#)



Terminals & Splices > Quick Disconnects

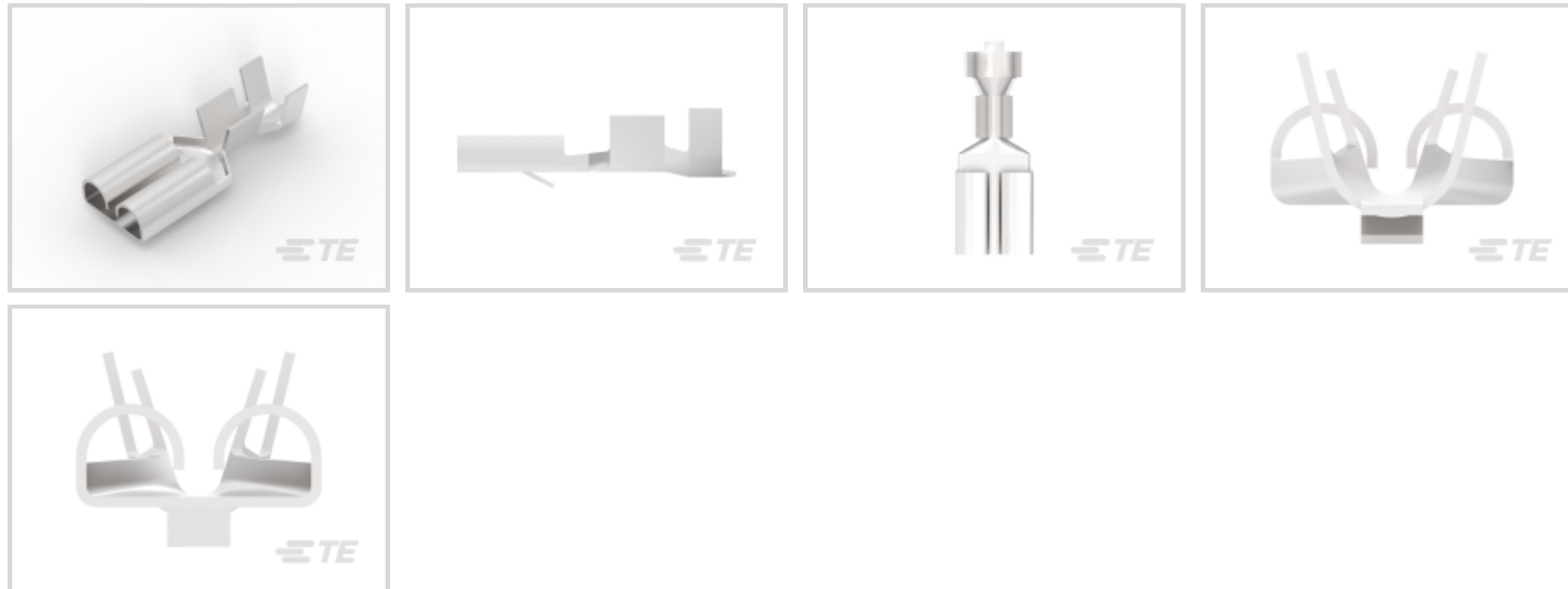

Quick Disconnect Terminal Type: **Receptacle**

Wire Size: 1.03 – 2.62 mm²

Mating Tab Width: 6.35 mm [.25 in]

Mating Tab Thickness: .81 mm [.032 in]

Features

Termination Features

Product Terminates To	Wire & Cable
-----------------------	--------------

Configuration Features

Compatible With Wire & Cable Type	Discrete Wire
-----------------------------------	---------------

Connection Capacity	Single
---------------------	--------

Mechanical Attachment

Locking Lance Height	1.2 mm[.05 in]
----------------------	----------------

Wire Insulation Support	With
-------------------------	------

Mating Retention Type	Locking Lance
-----------------------	---------------

Other

Line	FASTON .250
------	-------------

EU RoHS Compliance	Compliant
--------------------	-----------

EU ELV Compliance	Compliant
-------------------	-----------

Packaging Features

Packaging Quantity	500
--------------------	-----



Packaging Method

Loose Piece/Carton

Dimensions

Product Length

19.2 mm[.755 in]

Compatible Insulation Diameter Range

3.43 – 5.08 mm[.135 – .2 in]

Terminal Material Thickness

.33 mm[.013 in]

Wire Size

1.03 – 2.62 mm²

Product Type Features

Insertion Force

Normal

Contact Features

Quick Disconnect Terminal Type

Receptacle

Mating Tab Width

6.35 mm[.25 in]

Mating Tab Thickness

.81 mm[.032 in]

Terminal Orientation

Straight

Contact Base Material

Brass

Terminal Plating Material

Silver

Crimp Type

F-Crimp

Barrel Type

Open

Usage Conditions

Insulation Option

Uninsulated

Product Compliance

For compliance documentation, visit the product page on [TE.com](https://www.te.com)>

EU RoHS Directive 2011/65/EU

Compliant

EU ELV Directive 2000/53/EC

Compliant

China RoHS 2 Directive MIIT Order No 32, 2016

No Restricted Materials Above Threshold

EU REACH Regulation (EC) No. 1907/2006

Current ECHA Candidate List: JUNE 2024 (241)
Candidate List Declared Against: JUNE 2024 (241)
Does not contain REACH SVHC

Halogen Content

Low Halogen - Br, Cl, F, I < 900 ppm per homogenous material. Also BFR/CFR/PVC Free

Solder Process Capability

Not applicable for solder process capability

Product Compliance Disclaimer

This information is provided based on reasonable inquiry of our suppliers and represents our current actual knowledge based on the information they provided. This information is subject to change. The part numbers that TE has identified as EU RoHS compliant have a maximum concentration of 0.1% by weight in homogenous materials for lead, hexavalent chromium, mercury, PBB, PBDE, DBP, BBP, DEHP, DIBP, and 0.01% for cadmium, or qualify for an exemption to these limits as defined in the Annexes of Directive 2011/65/EU (RoHS2). Finished electrical and electronic equipment products will be CE marked as required by Directive 2011/65/EU. Components may not be CE marked. Additionally, the part numbers that TE has identified as EU ELV compliant have a maximum concentration of 0.1% by weight in homogenous materials for lead, hexavalent chromium, and mercury, and 0.01% for cadmium, or qualify for an exemption to these limits as defined in the Annexes of Directive 2000/53/EC (ELV). Regarding the REACH Regulation, the information TE provides on SVHC in articles for this part number is based on the latest European Chemicals Agency (ECHA) 'Guidance on requirements for substances in articles' posted at this URL: <https://echa.europa.eu/guidance-documents/guidance-on-reach>

Compatible Parts



Also in the Series | FASTIN-FASTON 250

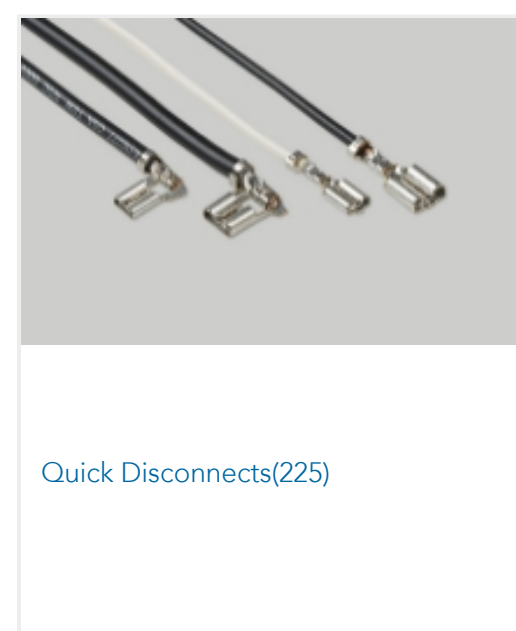
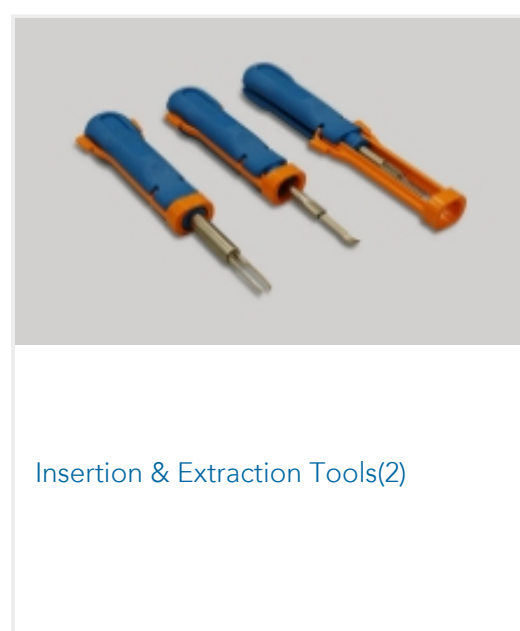
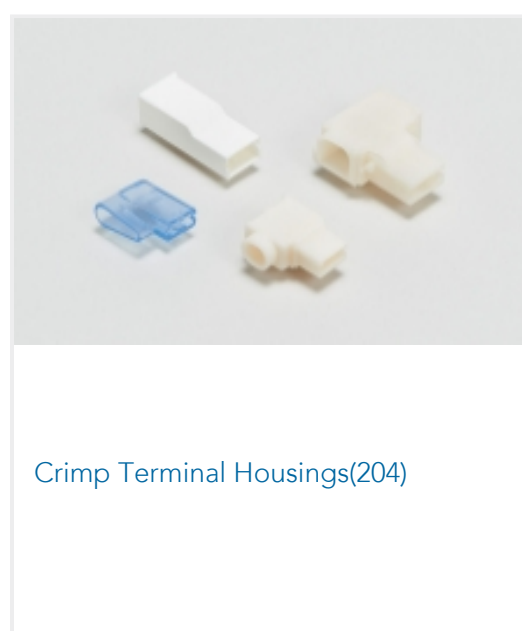

Customers Also Bought



TE Part #CB3127-000
D-1744-03-LF

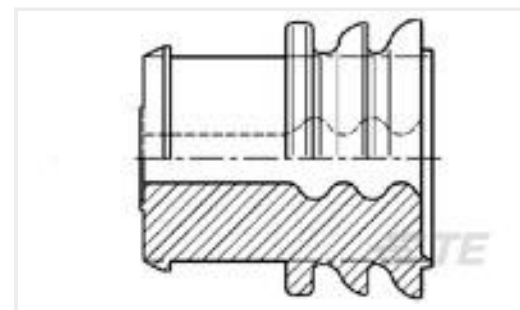

TE Part #963244-1
EINZELDRAHTDICHTUNG



TE Part #1241608-1
MQS1,5 Sn rec CB unseal. 0,75-1,5



TE Part #CB3125-000
D-1744-01-LF

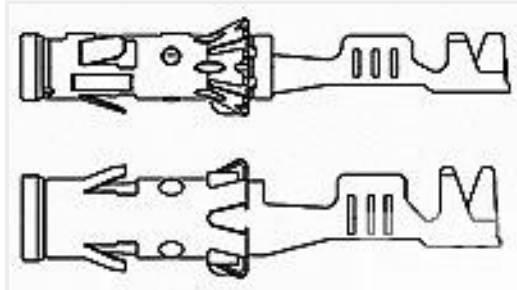

TE Part #929974-1
BU-KONTAKT 2,5MMD



TE Part #967398-000
D-406-0001



TE Part #1452409-2
SECONDARY LOCK FOR 58 POS
CONN

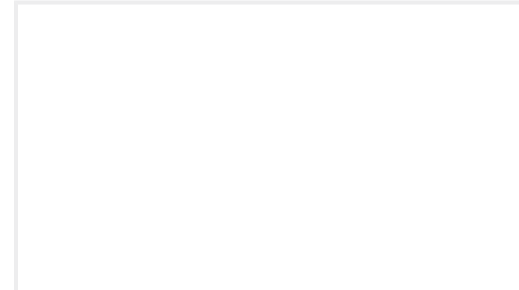

TE Part #ET0252-000
SGRS-2-96CS0064



TE Part #ET0251-000
SGRS-1-96CS0064



TE Part #160890-2
FF FLACHST 6,3 MIF

Documents

Product Drawings

[FF 250 REC 1-2.5MM2 BR SILVER PLATED LP](#)

English

CAD Files

[3D PDF](#)

3D

Customer View Model

[ENG_CVM_CVM_6-160449-6_U.2d_dxf.zip](#)

English

Customer View Model

[ENG_CVM_CVM_6-160449-6_U.3d_igs.zip](#)

English

Customer View Model

[ENG_CVM_CVM_6-160449-6_U.3d_stp.zip](#)

English

By downloading the CAD file I accept and agree to the [Terms and Conditions](#) of use.