

Product Compliance

[For compliance documentation, visit the product page on TE.com>](#)

EU RoHS Directive 2011/65/EU	Compliant
EU ELV Directive 2000/53/EC	Compliant
China RoHS 2 Directive MIIT Order No 32, 2016	No Restricted Materials Above Threshold
EU REACH Regulation (EC) No. 1907/2006	Current ECHA Candidate List: JUNE 2024 (241) Candidate List Declared Against: JUNE 2024 (241) Does not contain REACH SVHC
Halogen Content	Not Low Halogen - contains Br or Cl > 900 ppm.
Solder Process Capability	Reflow solder capable to 260°C

Product Compliance Disclaimer

This information is provided based on reasonable inquiry of our suppliers and represents our current actual knowledge based on the information they provided. This information is subject to change. The part numbers that TE has identified as EU RoHS compliant have a maximum concentration of 0.1% by weight in homogenous materials for lead, hexavalent chromium, mercury, PBB, PBDE, DBP, BBP, DEHP, DIBP, and 0.01% for cadmium, or qualify for an exemption to these limits as defined in the Annexes of Directive 2011/65/EU (RoHS2). Finished electrical and electronic equipment products will be CE marked as required by Directive 2011/65/EU. Components may not be CE marked. Additionally, the part numbers that TE has identified as EU ELV compliant have a maximum concentration of 0.1% by weight in homogenous materials for lead, hexavalent chromium, and mercury, and 0.01% for cadmium, or qualify for an exemption to these limits as defined in the Annexes of Directive 2000/53/EC (ELV). Regarding the REACH Regulation, the information TE provides on SVHC in articles for this part number is based on the latest European Chemicals Agency (ECHA) 'Guidance on requirements for substances in articles' posted at this URL: <https://echa.europa.eu/guidance-documents/guidance-on-reach>

Also in the Series | [Modu Connector System](#)

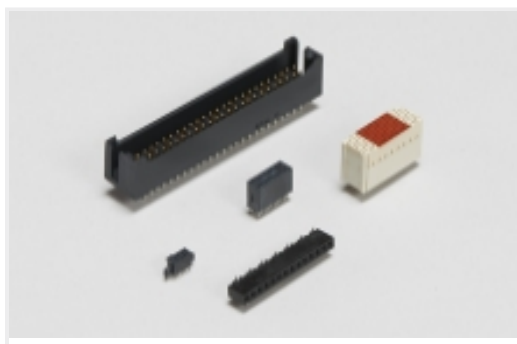

Board-to-Board Headers & Receptacles(814)

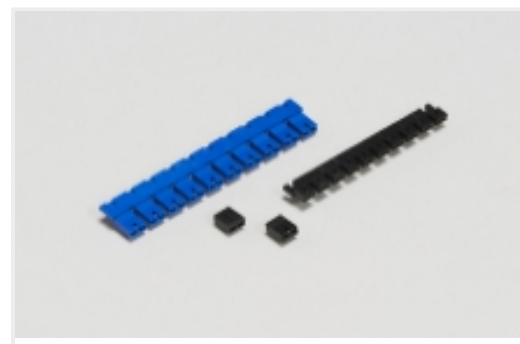

Board-to-Board Jumpers & Shunts(5)

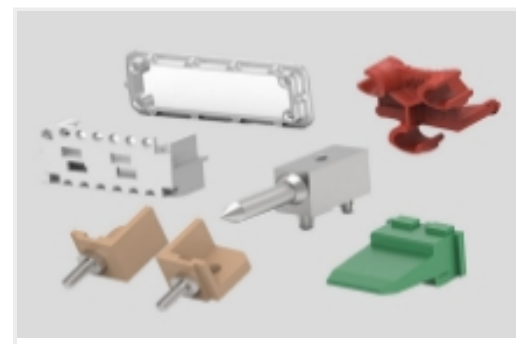

Connector Hardware(4)

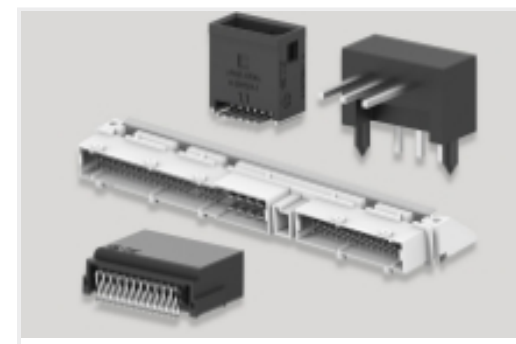

PCB Headers & Receptacles(814)

Customers Also Bought

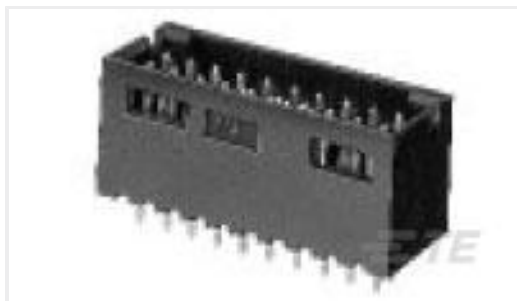

TE Part #6-103168-8
40 MODII HDR DRST SHRD .100CL

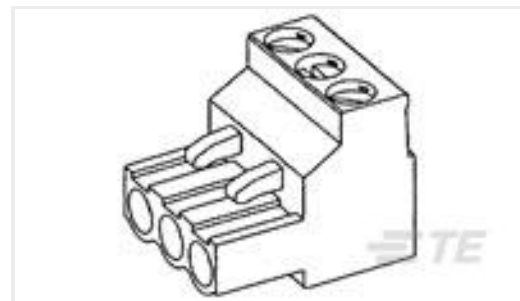

TE Part #796640-4
4 POS 5.0 MM R/A PLUG,TRM BLK



TE Part #1-66103-4
III+ PIN,24-20,30AU>10,SMPACK

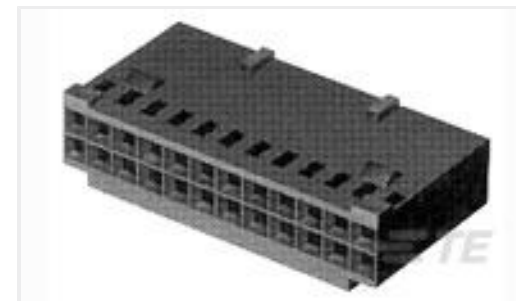

TE Part #3-87631-5
40 MODIV HSG COMP DR .100 POL



TE Part #1415898-1
RTS3T024



TE Part #1658649-1
KIT,HDP-20,OVRMLD,RCPT,SIZE 3,



TE Part #87230-4
08 MODII HDR DRRA UNSHRD .100



TE Part #826634-3
AMPMODU MOD II PIN HEADER



TE Part #2-1437569-0
164P2B11=RECT 2-POS SELECT INO



TE Part #8-324172-2
TERMINAL,PG SPD FLG 12-10 8

Documents

Product Drawings

[08 MODII HORZ DR CE EESS 100CL](#)

English

CAD Files

Customer View Model

[ENG_CVM_6-102084-2_Y.3d_igs.zip](#)

English

Customer View Model



[ENG_CVM_6-102084-2_Y.3d_stp.zip](#)

English

Customer View Model

[ENG_CVM_6-102084-2_Y.2d_dxf.zip](#)

English

3D PDF

English

By downloading the CAD file I accept and agree to the [Terms and Conditions](#) of use.

Product Specifications

Application Specification

English