



EUROCARD

TE Internal #: 5535034-4

Receptacle, Board-to-Board, 48 Position, 2.54 mm [.1 in] Centerline,
Printed Circuit Board, 3 Row, Vertical, 16 Column, Eurocard
Connectors

[View on TE.com >](#)

Connectors > PCB Connectors > Backplane Connectors > Eurocard Connectors

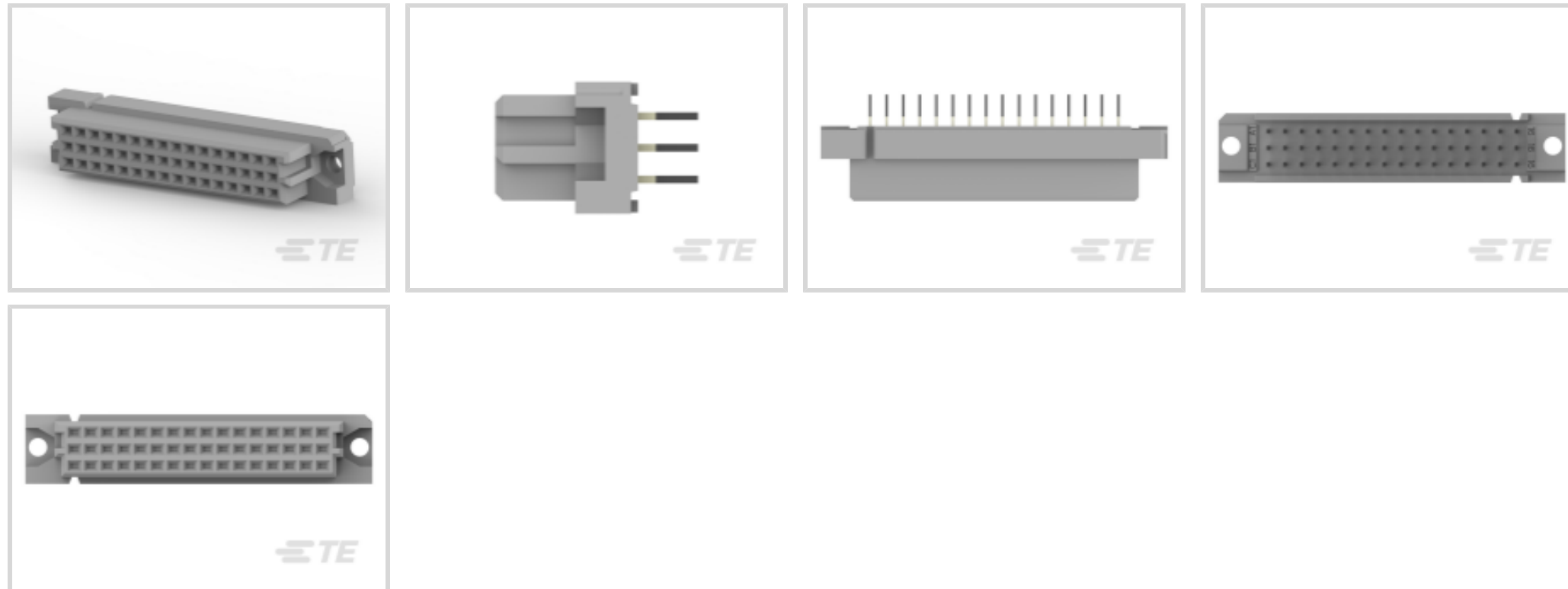

Connector & Housing Type: **Receptacle**

Connector System: **Board-to-Board**

Termination Post & Tail Length: **4.83 mm [.19 in]**

Number of Positions: **48**

Centerline (Pitch): **2.54 mm [.1 in]**

Features

Mechanical Attachment

Connector Mounting Type	Board Mount
-------------------------	-------------

Product Type Features

Connector & Housing Type	Receptacle
Connector System	Board-to-Board
Connector & Contact Terminates To	Printed Circuit Board
DIN Size	Half
DIN Level	II

Configuration Features

Number of Positions	48
Number of Rows	3
PCB Mount Orientation	Vertical
Number of Columns	16
Rows Loaded	A, B, C
Number of Signal Positions	48



Termination Features

Termination Post & Tail Length	4.83 mm[.19 in]
--------------------------------	-----------------

Housing Features

Centerline (Pitch)	2.54 mm[.1 in]
--------------------	----------------

Dimensions

Row-to-Row Spacing	2.54 mm[.1 in]
--------------------	----------------

Usage Conditions

Operating Temperature Range	-55 – 105 °C[-67 – 221 °F]
-----------------------------	----------------------------

Operation/Application

Circuit Application	Signal
---------------------	--------

Other

EU RoHS Compliance	Compliant
--------------------	-----------

EU ELV Compliance	Compliant
-------------------	-----------

Product Compliance

[For compliance documentation, visit the product page on TE.com>](#)

EU RoHS Directive 2011/65/EU	Compliant
------------------------------	-----------

EU ELV Directive 2000/53/EC	Compliant
-----------------------------	-----------

China RoHS 2 Directive MIIT Order No 32, 2016	No Restricted Materials Above Threshold
---	---

EU REACH Regulation (EC) No. 1907/2006	Current ECHA Candidate List: JUNE 2024 (241) Candidate List Declared Against: JUNE 2024 (241) Does not contain REACH SVHC
--	---

Halogen Content	Not Low Halogen - contains Br or Cl > 900 ppm.
-----------------	--

Solder Process Capability	Not applicable for solder process capability
---------------------------	--

Product Compliance Disclaimer

This information is provided based on reasonable inquiry of our suppliers and represents our current actual knowledge based on the information they provided. This information is subject to change. The part numbers that TE has identified as EU RoHS compliant have a maximum concentration of 0.1% by weight in homogenous materials for lead, hexavalent chromium, mercury, PBB, PBDE, DBP, BBP, DEHP, DIBP, and 0.01% for cadmium, or qualify for an exemption to these limits as defined in the Annexes of Directive 2011/65/EU (RoHS2). Finished electrical and electronic equipment products will be CE marked as required by Directive 2011/65/EU. Components may not be CE marked. Additionally, the part numbers that TE has identified as EU ELV compliant have a maximum concentration of 0.1% by weight in homogenous materials for lead, hexavalent chromium, and mercury, and 0.01% for cadmium, or qualify for an exemption to these limits as defined in the Annexes of Directive 2000/53/EC (ELV). Regarding the REACH Regulation, the information TE provides on SVHC in articles for this part number is based on the latest European Chemicals Agency (ECHA) 'Guidance on

requirements for substances in articles' posted at this URL: <https://echa.europa.eu/guidance-documents/guidance-on-reach>

Compatible Parts

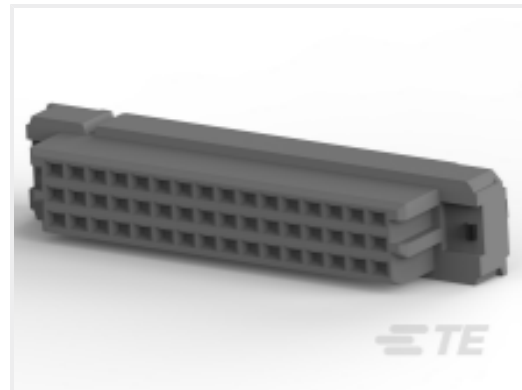

TE Part # 5536397-5
ASSY,RECEPT,EURO,TYPE C/2,LEAD

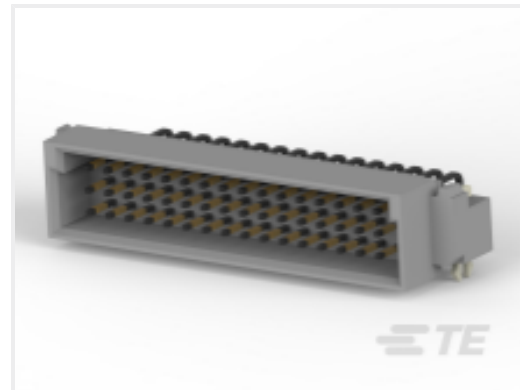

TE Part # 5650916-5
ASSY,PIN,EUROCARD,TYPE C/2,LEA



TE Part # 650948-5
048 EURO TYPE C PIN ST ASSY

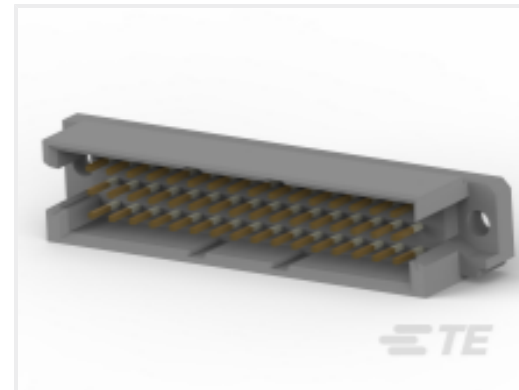

TE Part # 5650479-5
ASSY,PIN,EUROCARD,TYPE R/2,LEAD-FREE,48



TE Part # 536407-5
048 EURO TYPE C PIN BL ASSY



TE Part # 148020-5
048 EURO TYPE C PIN BL ASSY



TE Part # 650916-5
048 EURO TYPE C PIN BL ASSY



TE Part # 7-1393644-4
V42254B1200C410=PC612 MESSERLE

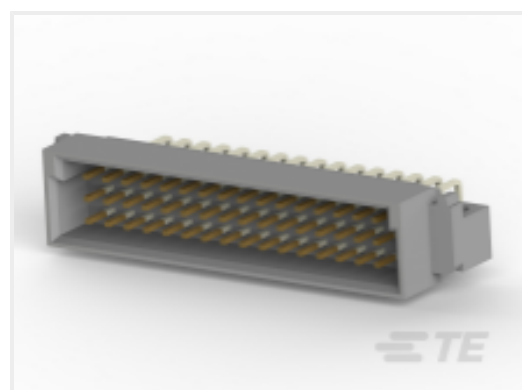

TE Part # 650478-5
048 EURO TYPE C PIN ST ASSY

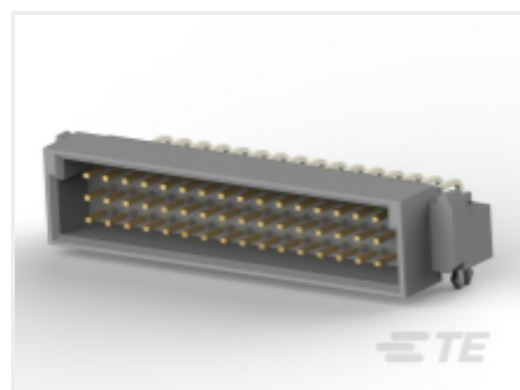

TE Part # 5148020-5
ASSY,PIN,EURO,"C/2",L-FREE,48



TE Part # 1393644-9
V42254B1100C480=PC612 MESSERLE



TE Part # 5536407-5
ASSY,PIN,EUROCARD,TYPE C/2,LEAD-FREE,48

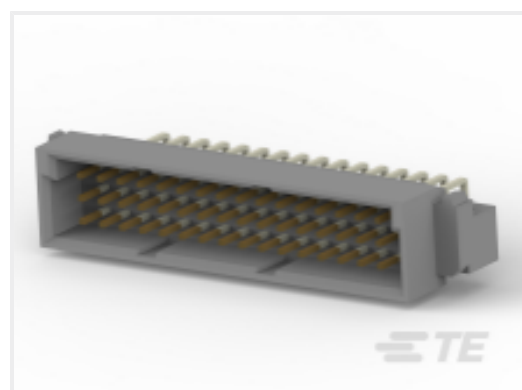

TE Part # 5650478-5
ASSY,PIN,EUROCARD,TYPE C/2,LEA

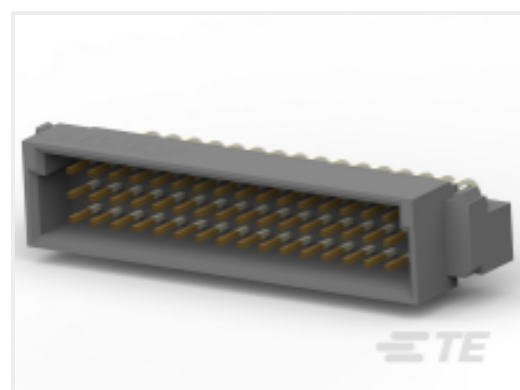

TE Part # 5650948-5
ASSY,PIN,EUROCARD,TYPE C/2,LEA



TE Part # 5535070-5
ASSY,RECEPTACLE,EUROCARD,TYPE



TE Part # 8-1393644-0
V42254B1200C480=PC612 MESSERLE

Customers Also Bought



TE Part #1775441-5
EMIX CONN., 1.5MM PITCH, RCPT,
HSG, 5P



TE Part #2199119-4
M.2 0.5PITCH 3.2H KEY E 15U" AU

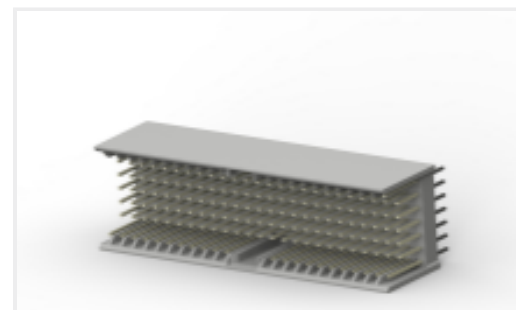

TE Part #5646529-1
Z-PACK 2MM HM TYPE A/B 169P



TE Part #1469374-1
ATCA GUIDE RIGHT ANGLE FEMALE



TE Part #2-1462038-1
IM43NS=IM RELAY 100mW 5V BIS



TE Part #3-1879334-9
CPF 0603 4R99 1% 50PPM 1K RL



TE Part #328970
BUDG R 22-16 COMM 22-18MIL 1/2



TE Part #6-6609107-9
PS0SXSS3B=C1176



TE Part #6469081-1
HMZD 3PR, RECEPTACLE ASSEMBLY

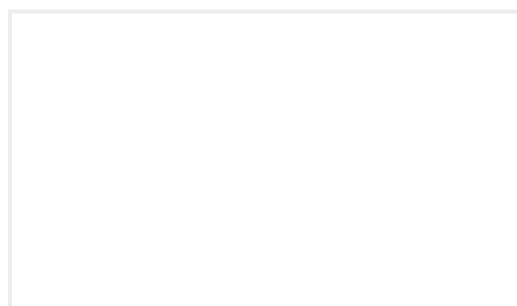

TE Part #2274073-1
HM ZD 3 PR HEADER, SEQ, LF

Documents

Product Drawings

[ASSY,RECEPTACLE,EUROCARD,TYPE C/2,L-FREE](#)

English

CAD Files

[3D PDF](#)

3D

Customer View Model

[ENG_CVM_CVM_5535034-4_A.2d_dxf.zip](#)

English

Customer View Model

[ENG_CVM_CVM_5535034-4_A.3d_igs.zip](#)

English

Customer View Model

[ENG_CVM_CVM_5535034-4_A.3d_stp.zip](#)

English

By downloading the CAD file I accept and agree to the [Terms and Conditions](#) of use.

Product Specifications



Application Specification

English

Agency Approvals

UL

English