

521488-1 ✓ ACTIVE

FASTON | FASTON 250, FASTON 187

TE Internal #: 521488-1

Receptacle, Receptacle, 3 Position, Straight, UL 94V-0, Natural, Nylon, Cable Mount (Free-Hanging), Carton, FASTON 187, Crimp Terminal Housings

[View on TE.com >](#)



Terminals & Splices > Terminal Housings, Insulation Sleeves & Blocks > Crimp Terminal Housings



Terminal Type: **Receptacle**

Connector & Housing Type: **Receptacle**

Number of Positions: **3**

Terminal Orientation: **Straight**

UL Flammability Rating: **UL 94V-0**

Features

Dimensions

.915 in

Packaging Features

Packaging Quantity

1

Packaging Method

Carton

Product Type Features

Sealable

No

Connector & Housing Type

Receptacle

Configuration Features

Number of Positions

3

Body Features

Primary Product Color

Natural

Contact Features

Terminal Type

Receptacle



Terminal Orientation	Straight
----------------------	----------

Contact Mating Retention	Without
--------------------------	---------

Mechanical Attachment

Mating Alignment	With
------------------	------

Connector Mounting Type	Cable Mount (Free-Hanging)
-------------------------	----------------------------

Housing Features

Housing Material	Nylon
------------------	-------

Centerline (Pitch)	8.63 mm, 45.87 mm[1.806 in][.34 in]
--------------------	-------------------------------------

Usage Conditions

Operating Temperature Range	-40 – 105 °C[-40 – 221 °F]
-----------------------------	----------------------------

Industry Standards

UL Flammability Rating	UL 94V-0
------------------------	----------

Other

EU RoHS Compliance	Compliant
--------------------	-----------

EU ELV Compliance	Compliant
-------------------	-----------

Product Compliance

[For compliance documentation, visit the product page on TE.com>](#)

EU RoHS Directive 2011/65/EU	Compliant
------------------------------	-----------

EU ELV Directive 2000/53/EC	Compliant
-----------------------------	-----------

China RoHS 2 Directive MIIT Order No 32, 2016	No Restricted Materials Above Threshold
---	---

EU REACH Regulation (EC) No. 1907/2006	Current ECHA Candidate List: JUNE 2024 (241) Candidate List Declared Against: JUNE 2024 (241) Does not contain REACH SVHC
--	---

Halogen Content	Low Halogen - Br, Cl, F, I < 900 ppm per homogenous material. Also BFR/CFR/PVC Free
-----------------	---

Solder Process Capability	Not applicable for solder process capability
---------------------------	--

Product Compliance Disclaimer

This information is provided based on reasonable inquiry of our suppliers and represents our current actual knowledge based on the information they provided. This information is subject to change. The part numbers that TE has identified as EU RoHS compliant have a maximum concentration of 0.1% by weight in homogenous materials for lead, hexavalent chromium, mercury, PBB, PBDE, DBP, BBP, DEHP, DIBP, and 0.01% for cadmium, or qualify for an exemption to these limits as defined in the Annexes of Directive 2011/65/EU (RoHS2). Finished electrical and electronic equipment products will be CE marked as required by Directive 2011/65/EU. Components may not be CE marked. Additionally, the part

numbers that TE has identified as EU ELV compliant have a maximum concentration of 0.1% by weight in homogenous materials for lead, hexavalent chromium, and mercury, and 0.01% for cadmium, or qualify for an exemption to these limits as defined in the Annexes of Directive 2000/53/EC (ELV). Regarding the REACH Regulation, the information TE provides on SVHC in articles for this part number is based on the latest European Chemicals Agency (ECHA) 'Guidance on requirements for substances in articles' posted at this URL: <https://echa.europa.eu/guidance-documents/guidance-on-reach>

Compatible Parts



Also in the Series | FASTON 187

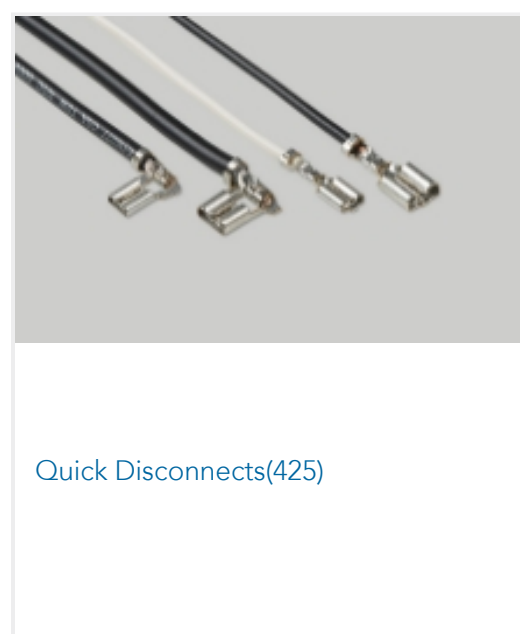
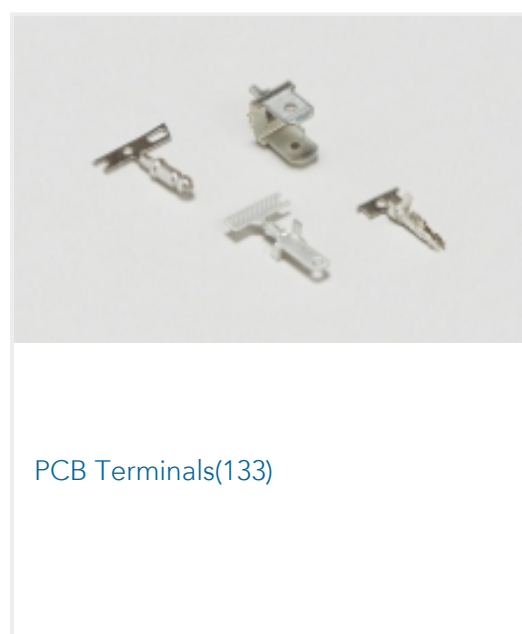
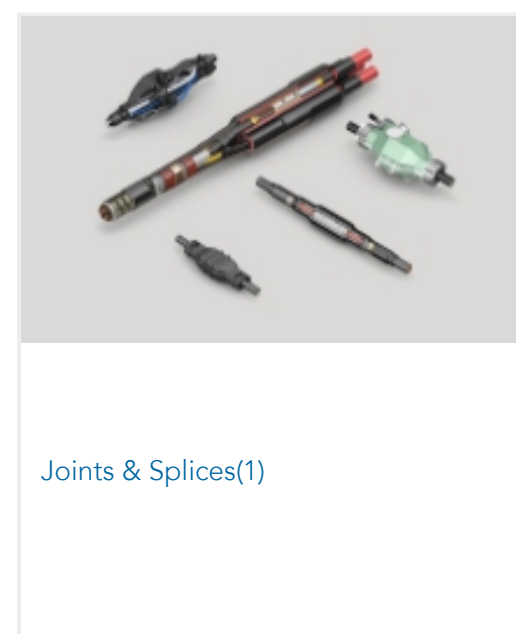
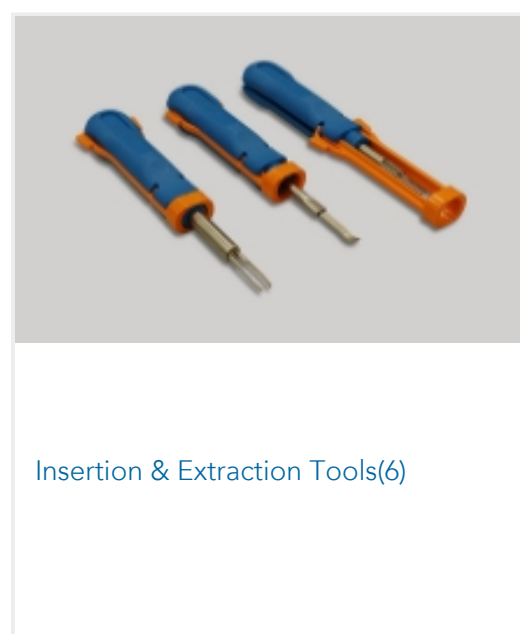
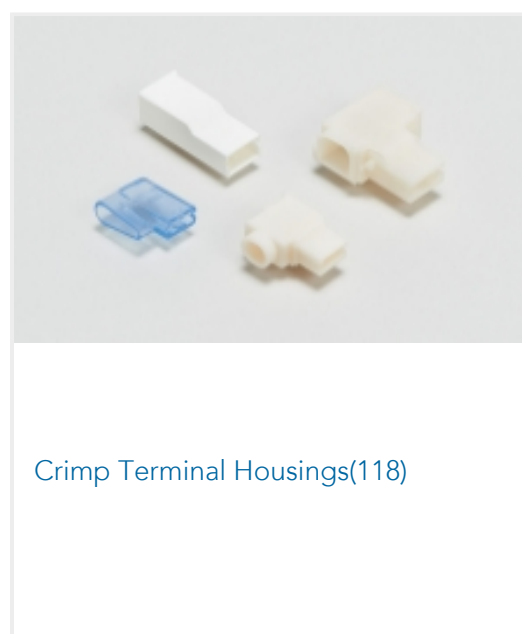

Also in the Series | FASTON 250

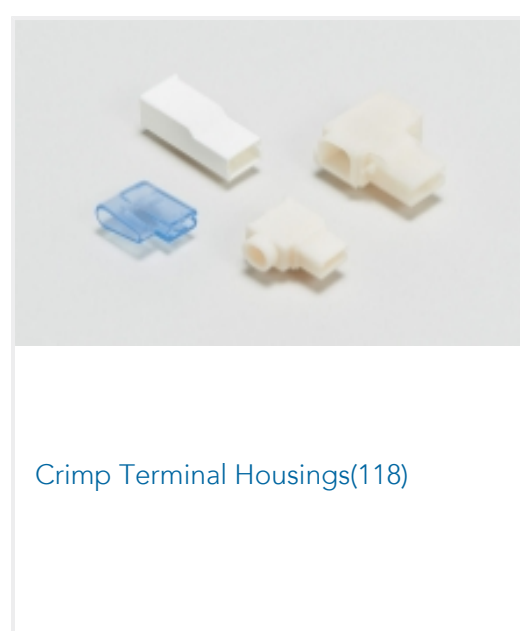
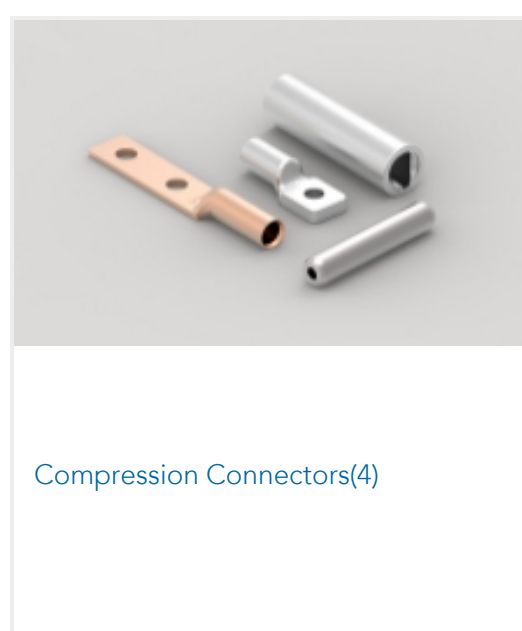



PCB Terminals(133)



Quick Disconnects(425)



Splices(4)

Customers Also Bought



TE Part #CAT-AM71-CH8172
AMP SUPERSEAL 1.5MM,
CONNECTOR HOUSING



TE Part #114017-ZZ
SEALING PLUG, SIZE 12/16, WHT



TE Part #DT04-2P
REC, 2P, GRY, N



TE Part #DT06-2S
PLG, 2P, GRY, N



TE Part #CAT-D487-W416
Wedgelocks: DEUTSCH DT



TE Part #CAT-D48-ST273
DEUTSCH Solid Contacts

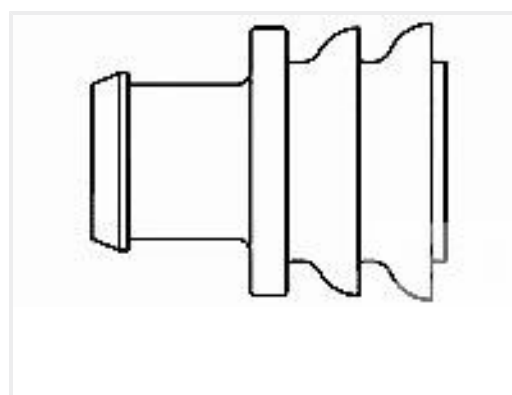

TE Part #281934-2
SINGLE WIRE SEAL

Documents

Product Drawings

[250/187 FASTON HSG. REC 3P NATURAL](#)

English

CAD Files

[3D PDF](#)

3D

Customer View Model

[ENG_CVM_CVM_521488-1_J_c-521488-1-j.2d_dxf.zip](#)

English

Customer View Model

[ENG_CVM_CVM_521488-1_J_c-521488-1-j.3d_igs.zip](#)

English

Customer View Model

[ENG_CVM_CVM_521488-1_J_c-521488-1-j.3d_stp.zip](#)

English

By downloading the CAD file I accept and agree to the [Terms and Conditions](#) of use.



[Agency Approvals](#)

[UL Report](#)

English