

521207-3 ✓ ACTIVE

RAST | RAST 5 IDC Connectors

TE Internal #: 521207-3

Housing, Receptacle, Wire-to-Wire, 5 Position, 5 mm [.197 in]  
Centerline, Crimp, 1 Row, Blue, Wire & Cable, Power & Signal,  
RAST 5 IDC Connectors

[View on TE.com >](#)



Connectors > PCB Connectors > Wire-to-Board Connectors > Wire-to-Board Connector Assemblies & Housings

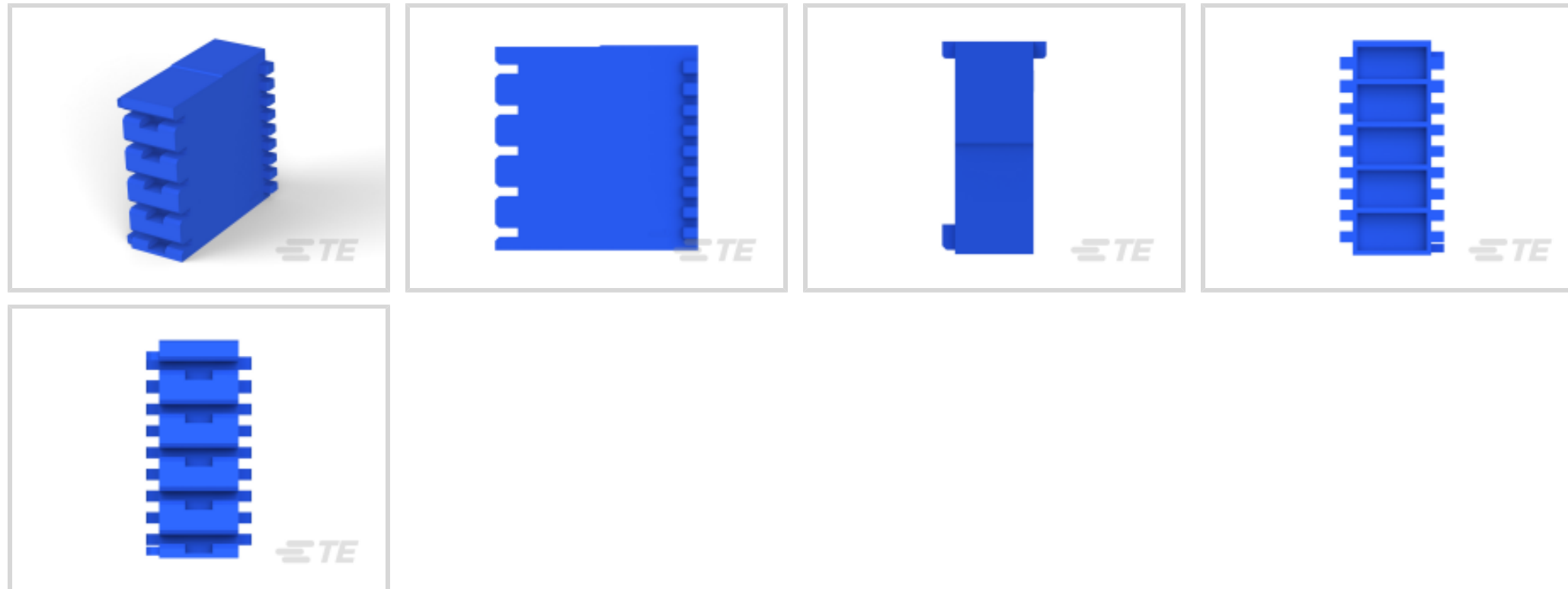

Connector Product Type: **Housing**

Connector & Housing Type: **Receptacle**

Connector System: **Wire-to-Wire**

Number of Positions: **5**

Centerline (Pitch): **5 mm [.197 in]**

## Features

### Contact Features

Contact Layout	Inline
Contact Base Material	Brass
Contact Type	Socket

### Industry Standards

UL Flammability Rating	UL 94V-0
Glow Wire Rating	Standard Part - Not Glow Wire

### Packaging Features

Packaging Method	Package
Packaging Quantity	1

### Mechanical Attachment

Strain Relief	Without
Panel Mount Feature	Without
Mating Retention Type	Latch
PCB Mount Retention	Without



Mating Retention	With
Connector Mounting Type	Cable Mount (Free-Hanging)

### Dimensions

Connector Height	12.2 mm [.48 in]
Connector Length	9.2 mm [.362 in]
Row-to-Row Spacing	5 mm [.197 in]

### Housing Features

Housing Material	Nylon 6/66
Housing Entry Configuration	Both Ends Closed
Centerline (Pitch)	5 mm [.197 in]

### Configuration Features

Keying & Polarized Position Locations	1C, 5D
Number of Positions	5
Number of Rows	1

### Product Type Features

Connector Product Type	Housing
Connector & Housing Type	Receptacle
Connector System	Wire-to-Wire
Sealable	No
Connector & Contact Terminates To	Wire & Cable

### Body Features

Primary Product Color	Blue
-----------------------	------

### Termination Features

Termination Method to Wire & Cable	Crimp
------------------------------------	-------

### Usage Conditions

Operating Temperature Range	-40 – 110 °C [-40 – 230 °F]
-----------------------------	-----------------------------

### Operation/Application

Circuit Application	Power & Signal
---------------------	----------------

### Other

EU RoHS Compliance	Compliant
EU ELV Compliance	Compliant



## Product Compliance

[For compliance documentation, visit the product page on TE.com>](#)

EU RoHS Directive 2011/65/EU	Compliant
EU ELV Directive 2000/53/EC	Compliant
China RoHS 2 Directive MIIT Order No 32, 2016	No Restricted Materials Above Threshold
EU REACH Regulation (EC) No. 1907/2006	Current ECHA Candidate List: JUNE 2024 (241) Candidate List Declared Against: JUNE 2024 (241) Does not contain REACH SVHC
Halogen Content	Low Halogen - Br, Cl, F, I < 900 ppm per homogenous material. Also BFR/CFR/PVC Free
Solder Process Capability	Not applicable for solder process capability

### Product Compliance Disclaimer

This information is provided based on reasonable inquiry of our suppliers and represents our current actual knowledge based on the information they provided. This information is subject to change. The part numbers that TE has identified as EU RoHS compliant have a maximum concentration of 0.1% by weight in homogenous materials for lead, hexavalent chromium, mercury, PBB, PBDE, DBP, BBP, DEHP, DIBP, and 0.01% for cadmium, or qualify for an exemption to these limits as defined in the Annexes of Directive 2011/65/EU (RoHS2). Finished electrical and electronic equipment products will be CE marked as required by Directive 2011/65/EU. Components may not be CE marked. Additionally, the part numbers that TE has identified as EU ELV compliant have a maximum concentration of 0.1% by weight in homogenous materials for lead, hexavalent chromium, and mercury, and 0.01% for cadmium, or qualify for an exemption to these limits as defined in the Annexes of Directive 2000/53/EC (ELV). Regarding the REACH Regulation, the information TE provides on SVHC in articles for this part number is based on the latest European Chemicals Agency (ECHA) 'Guidance on requirements for substances in articles' posted at this URL: <https://echa.europa.eu/guidance-documents/guidance-on-reach>

## Compatible Parts



TE Part # 521210-4  
HSG, POSILOCK, MKIII, 8 POS, 250



TE Part # 521206-4  
HSG, POSI-LOCK MKIII RAST, 4P



TE Part # 521209-1  
POSI-LOK HSG.250-7 POS RAST5



TE Part # 521209-2  
HSG POSI-LOCK MARK III



Also in the Series | **RAST 5 IDC Connectors**

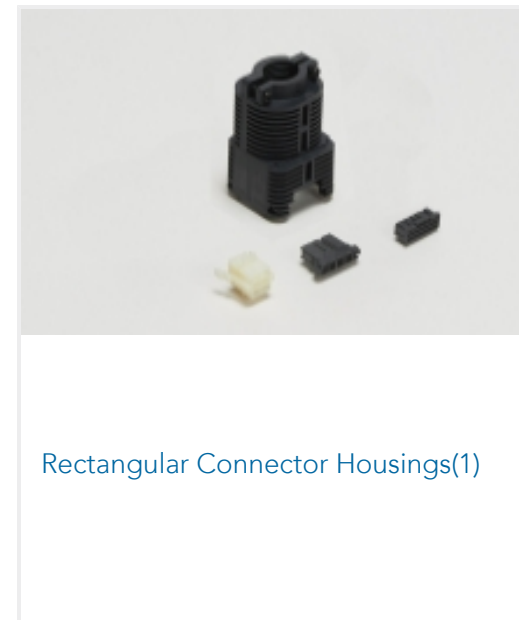
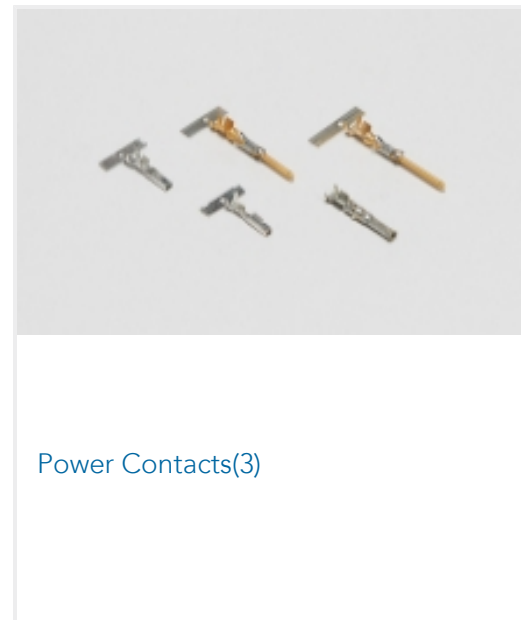
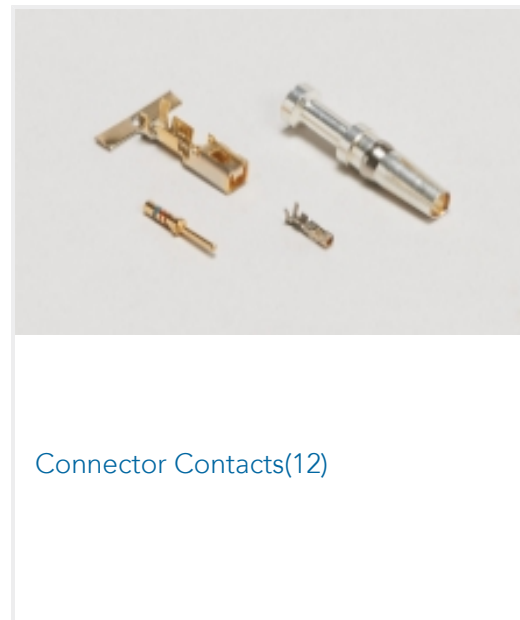
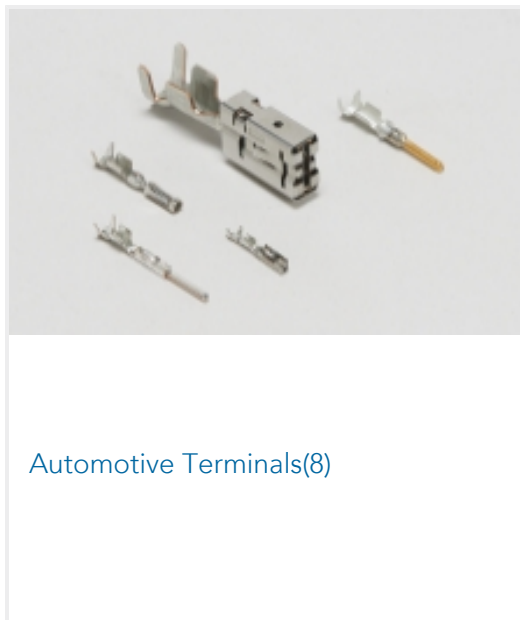

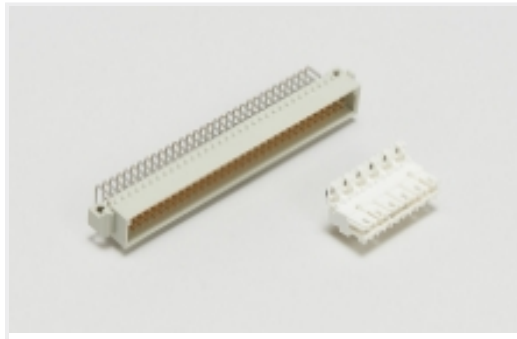

Standard Edge Connectors(31)

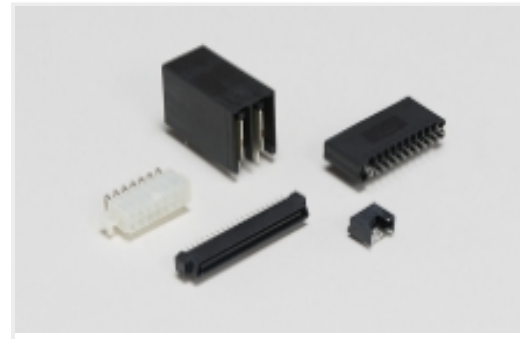

Standard Rectangular Connectors(64)

## Customers Also Bought

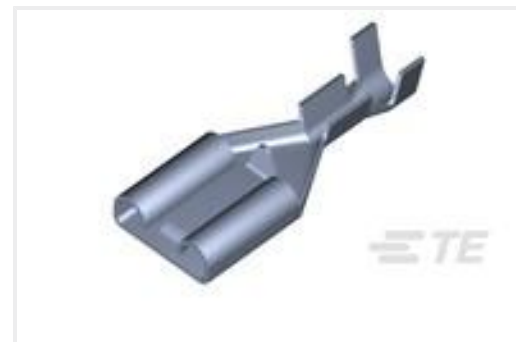
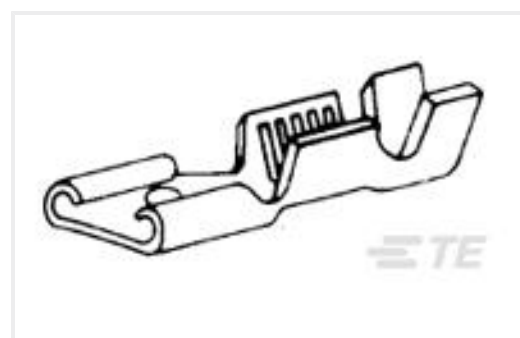
TE Part #1-1393210-2  
T9AS1D12-110TE Part #1-1393239-6  
RT114110TE Part #1217095-2  
RCPT 250 POS-LOCK 16-12 TPBRTE Part #521205-9  
RAST 5 HSG,3PTE Part #4-1565085-2  
GIC 3.5W 2P CAP FTE Part #1801179-1  
3W RECEPTACLE HPSL CONNECTOR  
BLACKTE Part #1217378-2  
RCPT 250POS-LOC 22-18 0126TPBRTE Part #1558671-7  
T9GV1L24-24TE Part #1217094-2  
RCPT 250 POS-LOCK 18-14 TPBRTE Part #60384-2  
.250 FAST REC IS 1000 TPBR

## Documents

### Product Drawings

[HSG POSI-LOCK MARK III](#)

English

### CAD Files

[3D PDF](#)

3D

[Customer View Model](#)

[ENG\\_CVM\\_CVM\\_521207-3\\_P.2d\\_dxf.zip](#)



English

**Customer View Model**

[ENG\\_CVM\\_CVM\\_521207-3\\_P.3d\\_igs.zip](#)

English

**Customer View Model**

[ENG\\_CVM\\_CVM\\_521207-3\\_P.3d\\_stp.zip](#)

English

By downloading the CAD file I accept and agree to the [Terms and Conditions](#) of use.

---

**Datasheets & Catalog Pages**

[RAST Connector System Catalog](#)

English

---

**Agency Approvals**

[UL Report](#)

English