

4-1825059-1 ✓ ACTIVE

[Alcoswitch](#) | [Alcoswitch DIP ADF](#), [Alcoswitch DIP](#)

TE Internal #: 4-1825059-1

DIP Switch, Gold Flash Contact Plating, Black, Polyphenylene Sulfide (PPS), Sealed, 8 Switch, -30 – 85 °C, Alcoswitch DIP

[View on TE.com >](#)



Switches > DIP & SIP Switches

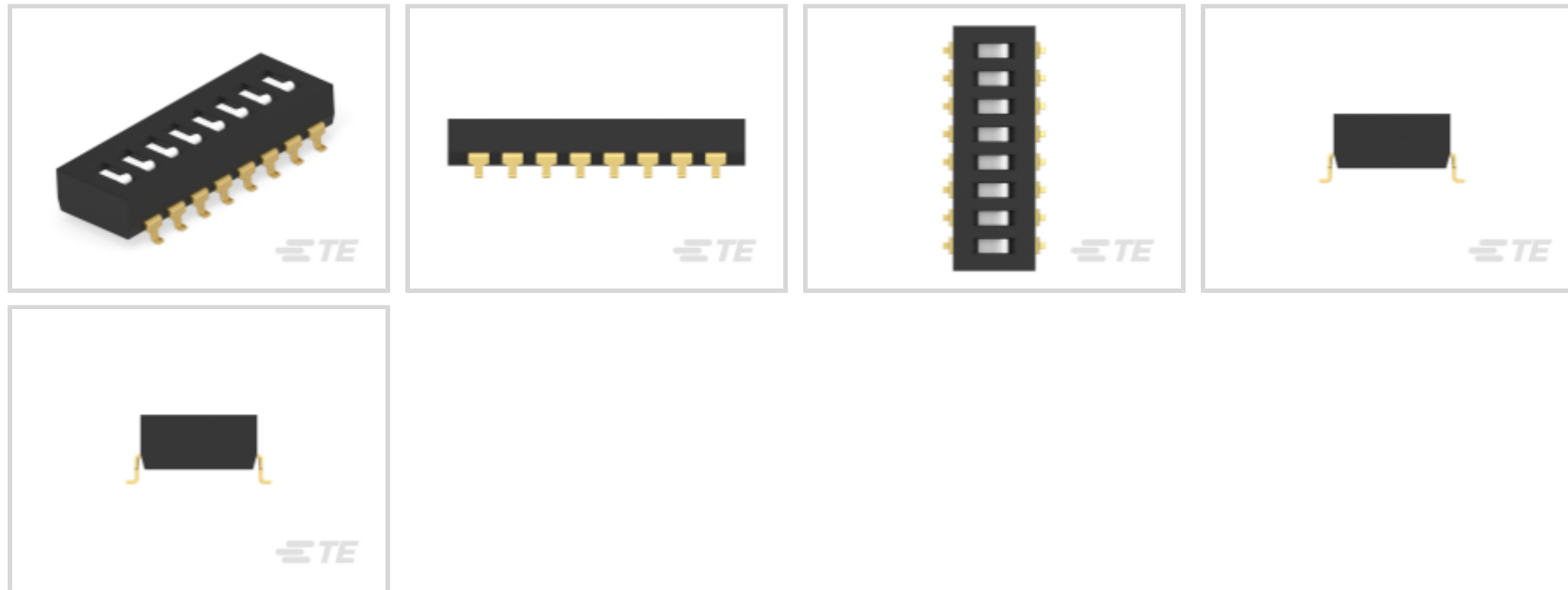

DIP & SIP Switch Type: **DIP**

Switch Contact Plating Material: **Gold Flash**

Case Color: **Black**

Case Material: **Polyphenylene Sulfide (PPS)**

Sealed Device: **Yes**

## Features

### Operation/Application

Assembly Process Feature	Auto-Insert Packaging
--------------------------	-----------------------

### Industry Standards

UL Flammability Rating	UL 94V-0
------------------------	----------

### Dimensions

Product Length	22.3 mm[.878 in]
----------------	------------------

Product Height	3.5 mm[.138 in]
----------------	-----------------

### Packaging Features

Packaging Method	Tube
------------------	------

Packaging Quantity	20
--------------------	----

### Configuration Features

Number of Positions	8
---------------------	---

Number of Switches	8
--------------------	---

Configuration (Pole-Throw)	Single Pole - Single Throw
----------------------------	----------------------------

### Body Features



Sealing Method	Sealing Tape
Actuator Color	White
Case Color	Black
Case Material	Polyphenylene Sulfide (PPS)

### Contact Features

Contact Underplating Material	Nickel
	1.2 µin
PCB Contact Termination Area Plating Material	Gold Flash
Switch Contact Plating Material	Gold Flash
Contact Base Material	Copper Alloy

### Product Type Features

Leg Style	Gull Wing
DIP & SIP Switch Type	DIP
Sealed Device	Yes
Actuator Style	Flush Actuator, Slide Actuator

### Usage Conditions

Operating Temperature Range	-30 – 85 °C
-----------------------------	-------------

### Electrical Characteristics

Contact Current Rating	1 A
Operating Voltage	5 VDC

### Termination Features

Termination Method to PCB	Surface Mount
---------------------------	---------------

### Housing Features

Centerline (Pitch)	2.54 mm [.1 in]
--------------------	-----------------

### Other

EU RoHS Compliance	Compliant
EU ELV Compliance	Compliant

### Product Compliance

For compliance documentation, visit the product page on [TE.com](https://www.te.com)>

EU RoHS Directive 2011/65/EU	Compliant
EU ELV Directive 2000/53/EC	Compliant



China RoHS 2 Directive MIIT Order No 32, 2016	No Restricted Materials Above Threshold
EU REACH Regulation (EC) No. 1907/2006	Current ECHA Candidate List: JUNE 2024 (241) Candidate List Declared Against: JUNE 2024 (241) Does not contain REACH SVHC
Halogen Content	Not Low Halogen - contains Br or Cl > 900 ppm.
Solder Process Capability	Reflow solder capable to 260°C

Product Compliance Disclaimer

This information is provided based on reasonable inquiry of our suppliers and represents our current actual knowledge based on the information they provided. This information is subject to change. The part numbers that TE has identified as EU RoHS compliant have a maximum concentration of 0.1% by weight in homogenous materials for lead, hexavalent chromium, mercury, PBB, PBDE, DBP, BBP, DEHP, DIBP, and 0.01% for cadmium, or qualify for an exemption to these limits as defined in the Annexes of Directive 2011/65/EU (RoHS2). Finished electrical and electronic equipment products will be CE marked as required by Directive 2011/65/EU. Components may not be CE marked. Additionally, the part numbers that TE has identified as EU ELV compliant have a maximum concentration of 0.1% by weight in homogenous materials for lead, hexavalent chromium, and mercury, and 0.01% for cadmium, or qualify for an exemption to these limits as defined in the Annexes of Directive 2000/53/EC (ELV). Regarding the REACH Regulation, the information TE provides on SVHC in articles for this part number is based on the latest European Chemicals Agency (ECHA) 'Guidance on requirements for substances in articles' posted at this URL: <https://echa.europa.eu/guidance-documents/guidance-on-reach>

## Compatible Parts

TE Part # 1814425-2 ADF08STTR04900	TE Part # 5-1825059-4 ADF10STTR04=DIP S,FLUSH,SMT-GW	TE Part # 4-1825059-2 ADF08STTR04=DIP S,FLUSH,SMT-GW	TE Part # 6-1825059-3 ADF06STR04
TE Part # 1-1825059-8 ADF04STTR04=DIP S,FLUSH,SMT-GW	TE Part # 1-1825059-3 ADF04S04=DIP SWT,FLUSH,SMT-GW		

Also in the Series | [Alcoswitch DIP ADF](#)

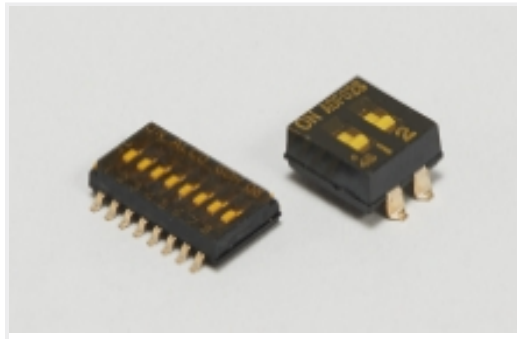

DIP & SIP Switches(160)

### Also in the Series | Alcoswitch DIP

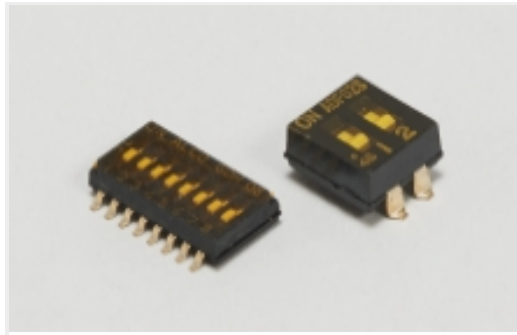

DIP & SIP Switches(160)



Rotary Switches(16)

### Customers Also Bought



TE Part #1-177662-2  
D3100 HDR,5POS SINGLE ROW SMT HORIZONTAL

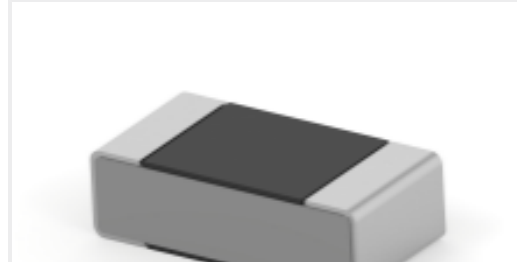

TE Part #6-1879216-1  
CPF 0402 226K 0.1% 25PPM 1K RL



TE Part #1473149-1  
SEMI-HARD TRAY ASSY DDR 200P 5



TE Part #2-34117-2  
SOLIS SPD 22-16COMM 22-18MIL 8



TE Part #414026-3  
JACK ASSY,SMB,RT ANG

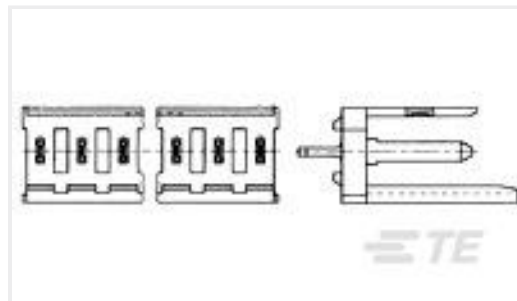

TE Part #280617-1  
06P MOD 1 P.S.ASSY



TE Part #3-111196-3  
80 RCPT SYSTEM 50 30 DPLX

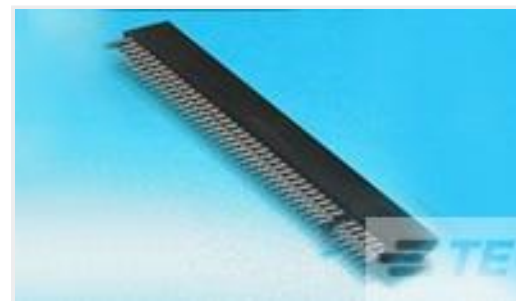

TE Part #6-5530843-5  
CONN SEC II 31 POS 100C/L

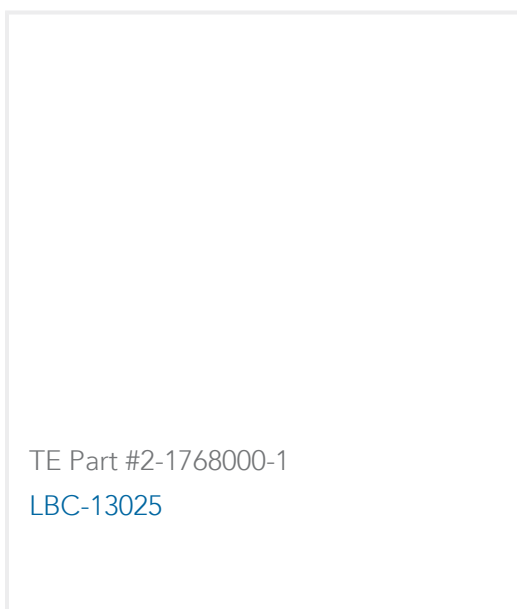

TE Part #2-1768000-1  
LBC-13025



TE Part #1977263-2  
FSM1LPSTR=ESD GND SMD TACT SWITCH



## Documents

### Product Drawings

[ADF08ST04=DIP SWT,FLUSH,SMT-GW](#)

English

---

### CAD Files

[3D PDF](#)

3D

Customer View Model

[ENG\\_CVM\\_CVM\\_4-1825059-1\\_B.2d\\_dxf.zip](#)

English

Customer View Model

[ENG\\_CVM\\_CVM\\_4-1825059-1\\_B.3d\\_igs.zip](#)

English

Customer View Model

[ENG\\_CVM\\_CVM\\_4-1825059-1\\_B.3d\\_stp.zip](#)

English

By downloading the CAD file I accept and agree to the [Terms and Conditions](#) of use.

---

### Datasheets & Catalog Pages

[SWITCHES\\_CORE\\_PROGRAM\\_CATALOG](#)

English

[ADE\\_ADP\\_ADF\\_Datasheet](#)

English