

3-644020-3 ✓ ACTIVE

MTA 100

TE Internal #: 3-644020-3

Connector Assembly, Receptacle, Insulation Displacement (IDC),  
Wire-to-Board, MTA 100, Standard Rectangular Connectors

[View on TE.com >](#)



Connectors > Rectangular Connectors > Standard Rectangular Connectors >

Nylon Gold Plated Receptacle: 2.54 mm, with Mating Alignment, MTA 100



Connector Product Type: **Connector Assembly**

Connector & Housing Type: **Receptacle**

Mating Alignment: **With**

Mating Alignment Type: **Polarization**

Mating Retention: **With**

[All Nylon Gold Plated Receptacle: 2.54 mm, with Mating Alignment, MTA 100 \(74\)](#)

## Features

### Body Features

Primary Product Color	White
-----------------------	-------

### Packaging Features

Packaging Quantity	500
Packaging Method	Bag/Box

### Dimensions

Connector Width	6.99 mm[.275 in]
Connector Height	13.21 mm[.52 in]
Wire Size	24 AWG
Connector Length	7.62 mm[.3 in]

### Housing Features

Housing Material	Nylon 6/6
Centerline (Pitch)	2.54 mm[.1 in]



### Configuration Features

Number of Cavities	3
Contacts Preloaded	Yes
Number of Positions	3
Number of Rows	1

### Industry Standards

Compatible With Agency/Standards Products	UL, CSA
UL Rating	Recognized
Compatible With Approved Standards Products	UL E28476
CSA Rating	LR 7189
UL Flammability Rating	UL 94V-2

### Contact Features

Contact Underplating Material	Nickel
Wire Contact Termination Area Plating Material	Tin
Contact Type	Receptacle
Contact Mating Area Plating Material	Gold Flash over Palladium Nickel, Gold
Contact Retention Within Housing	With
Contact Current Rating (Max)	5 A

### Mechanical Attachment

Contact Retention Type Within Housing	Locking Lance
Mating Alignment	With
Mating Alignment Type	Polarization
Mating Retention	With
Mating Retention Type	Locking Ramp
Connector Mounting Type	Cable Mount (Free-Hanging)

### Product Type Features

Compatible With Discrete Wire Type	Stranded
Connector Product Type	Connector Assembly
Connector & Housing Type	Receptacle
Connector System	Wire-to-Board
Insertion Force Type	Normal
Sealable	No



Connector & Contact Terminates To	Wire & Cable
-----------------------------------	--------------

### Termination Features

Termination Method to Wire & Cable	Insulation Displacement (IDC)
------------------------------------	-------------------------------

### Electrical Characteristics

Operating Voltage	250 VAC
-------------------	---------

### Usage Conditions

Operating Temperature Range	-55 – 105 °C[-67 – 221 °F]
-----------------------------	----------------------------

### Operation/Application

Shielded	No
----------	----

Circuit Application	Signal
---------------------	--------

### Other

EU RoHS Compliance	Compliant
--------------------	-----------

EU ELV Compliance	Compliant
-------------------	-----------

### Product Compliance

[For compliance documentation, visit the product page on TE.com>](#)

EU RoHS Directive 2011/65/EU	Compliant
------------------------------	-----------

EU ELV Directive 2000/53/EC	Compliant
-----------------------------	-----------

China RoHS 2 Directive MIIT Order No 32, 2016	No Restricted Materials Above Threshold
---	---

EU REACH Regulation (EC) No. 1907/2006	Current ECHA Candidate List: JUNE 2024 (241) Candidate List Declared Against: JUNE 2024 (241) Does not contain REACH SVHC
--	---

Halogen Content	Low Halogen - Br, Cl, F, I < 900 ppm per homogenous material. Also BFR/CFR/PVC Free
-----------------	---

Solder Process Capability	Not applicable for solder process capability
---------------------------	--

#### Product Compliance Disclaimer

This information is provided based on reasonable inquiry of our suppliers and represents our current actual knowledge based on the information they provided. This information is subject to change. The part numbers that TE has identified as EU RoHS compliant have a maximum concentration of 0.1% by weight in homogenous materials for lead, hexavalent chromium, mercury, PBB, PBDE, DBP, BBP, DEHP, DIBP, and 0.01% for cadmium, or qualify for an exemption to these limits as defined in the Annexes of Directive 2011/65/EU (RoHS2). Finished electrical and electronic equipment products will be CE marked as required by Directive 2011/65/EU. Components may not be CE marked. Additionally, the part numbers that TE has identified as EU ELV compliant have a maximum concentration of 0.1% by weight in homogenous materials for lead, hexavalent chromium, and mercury, and 0.01% for cadmium, or qualify for an exemption to these limits as defined in the Annexes of Directive 2000/53/EC (ELV). Regarding the REACH Regulation, the information TE provides on SVHC in articles for this part number is based on the latest European Chemicals Agency (ECHA) 'Guidance on

requirements for substances in articles' posted at this URL: <https://echa.europa.eu/guidance-documents/guidance-on-reach>

## Compatible Parts



TE Part # CAT-104MTA-NYLCC  
Nylon PCB Connector Covers: 2.54 mm, MTA 100



TE Part # 58074-1  
MTA 50/100/156 MANUAL TOOL FRAME



TE Part # 3-647117-3  
03P MTA100 HDR HT FL 30AU LF

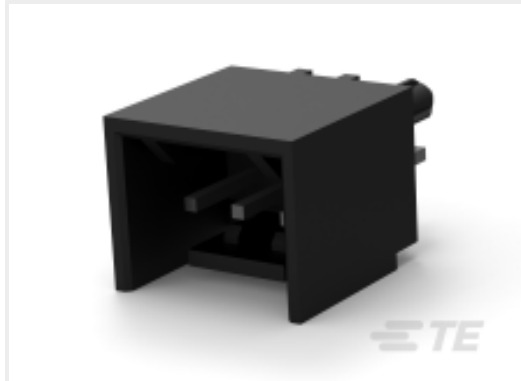

TE Part # 2-644487-3  
03P MTA100 SHRD HDR ASSY 30AU

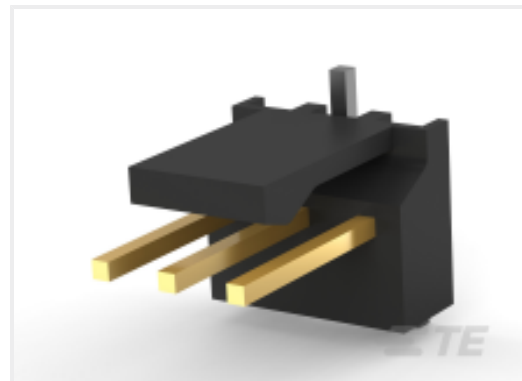

TE Part # 3-647168-3  
03P MTA100 HDR ASSY SM 30AU LF



TE Part # 3-641213-3  
03P MTA100 HDR ASSY PO/ST LF



TE Part # CAT-104MTA-PVUNH  
PCB Header: Polyester, Vertical, Unshrouded, No Mating Alignment



TE Part # 58579-1  
MTA 100 MANUAL TOOL ASSEMBLY DISCRETE



TE Part # 58246-3  
MTA 100 CRIMP HEAD PRODUCTION RBBN CABLE

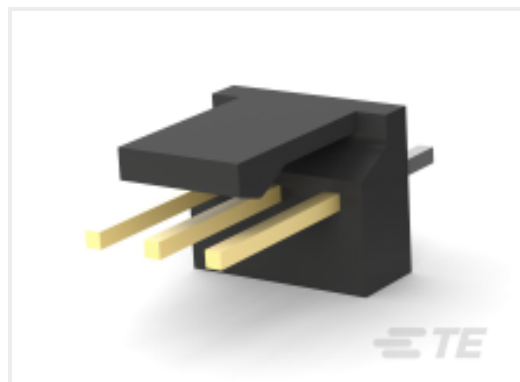

TE Part # 3-647116-3  
03P MTA100 HDR HT FL 30AU LF



TE Part # 58246-2  
MTA 100 CRIMP HEAD PRODUCTION DISCRETE



TE Part # CAT-104MTA-PVBRH  
Polyester Vertical PCB Header: 2.54 mm, Breakaway, MTA 100



TE Part # 2-644489-3  
03P MTA100 SHRD HDR R/A 30AU L



TE Part # 3-641216-3  
03P MTA100 HDR ASSY FL/RA LF



TE Part # CAT-104MTA-PLSCC  
Polyester PCB Connector Covers: 2.54 mm, MTA 100

## Also in the Series | MTA 100

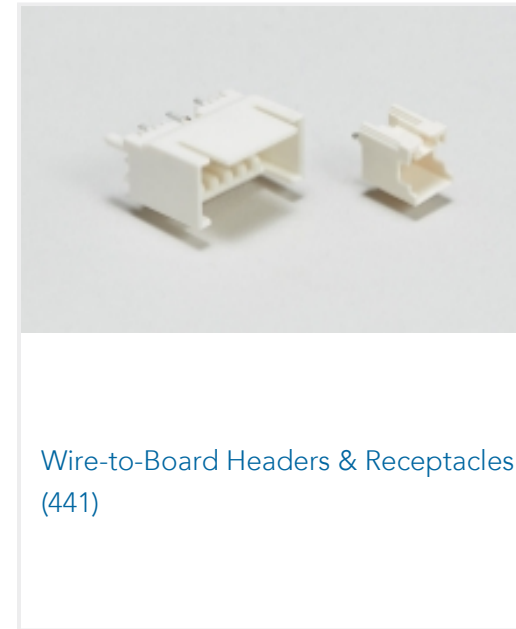
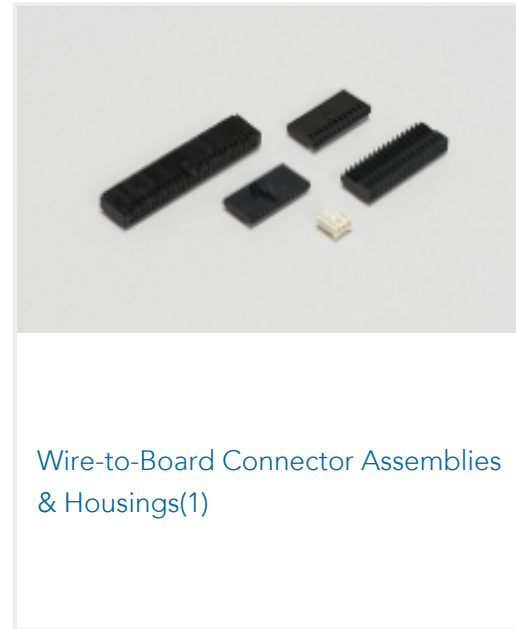
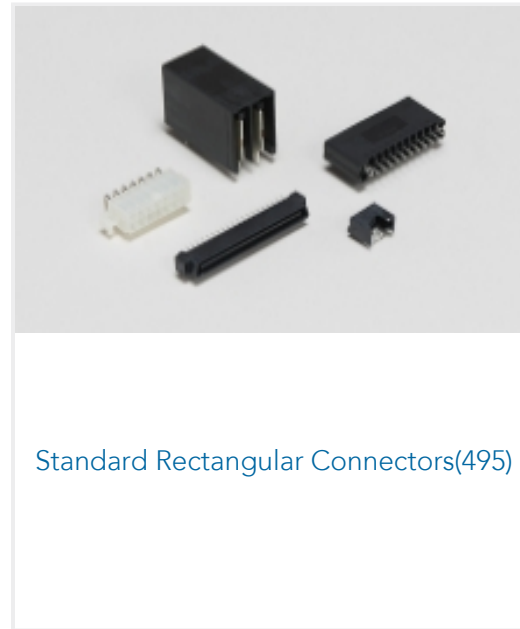
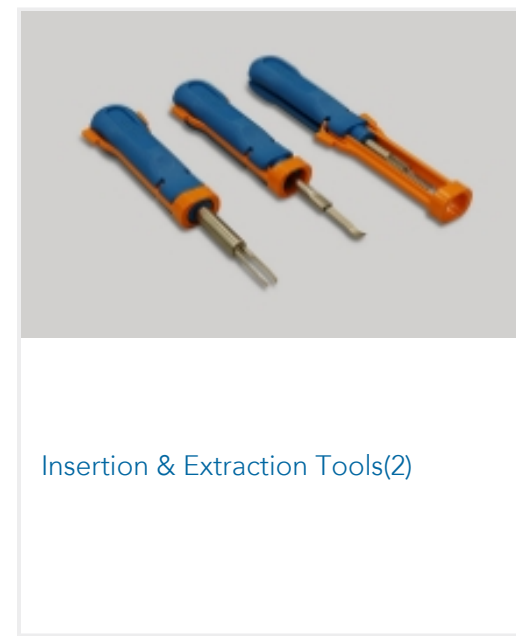
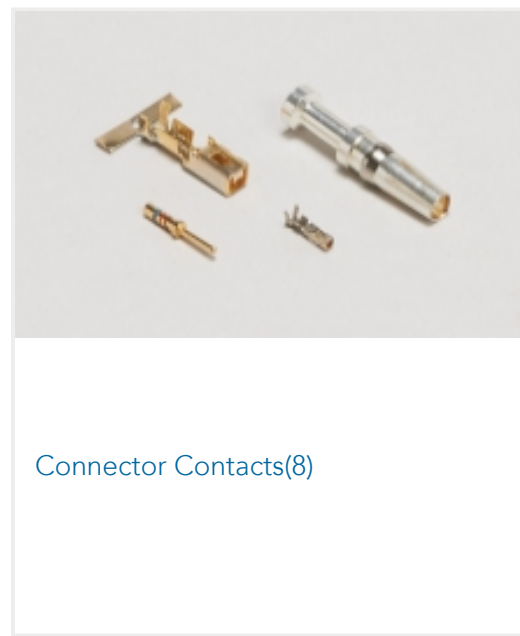

### Customers Also Bought

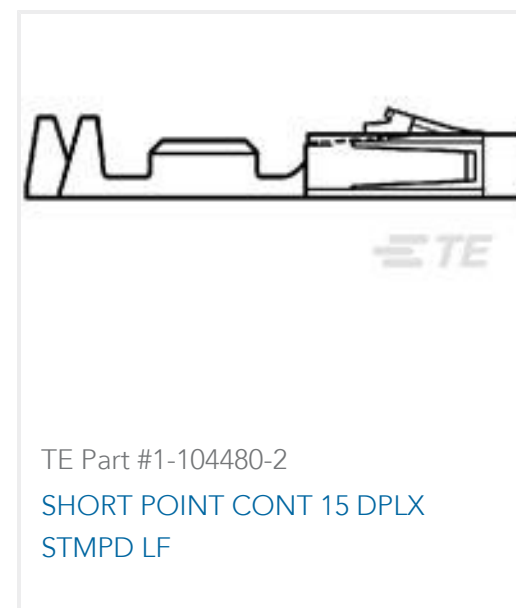
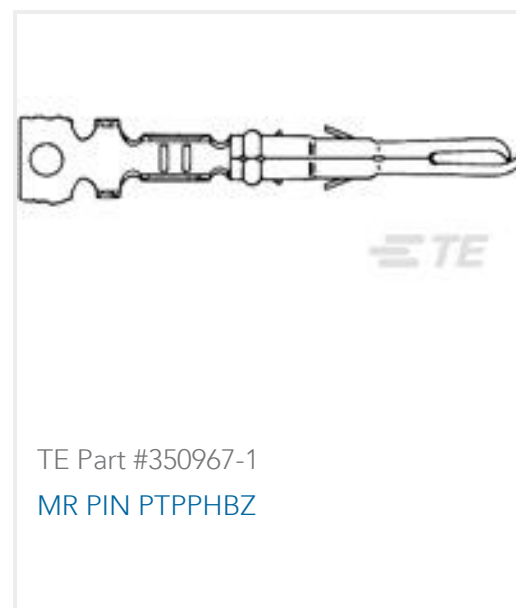

### Documents



### Product Drawings

[03P MTA100 CONN ASSY 30AU](#)

English

---

### CAD Files

[3D PDF](#)

3D

Customer View Model

[ENG\\_CVM\\_CVM\\_3-644020-3\\_M.2d\\_dxf.zip](#)

English

Customer View Model

[ENG\\_CVM\\_CVM\\_3-644020-3\\_M.3d\\_igs.zip](#)

English

Customer View Model

[ENG\\_CVM\\_CVM\\_3-644020-3\\_M.3d\\_stp.zip](#)

English

By downloading the CAD file I accept and agree to the [Terms and Conditions](#) of use.

---

### Product Specifications

[Application Specification](#)

English

---

### Agency Approvals

[Agency Approval Document](#)

English