

3-640600-7 ✓ ACTIVE



MTA 156

TE Internal #: 3-640600-7

7 Position, Receptacle, Connector Assembly, Insulation

Displacement (IDC), Wire-to-Board, Tin (Sn), Normal, UL 94V-2,

MTA 156

[View on TE.com >](#)

Connectors > Rectangular Connectors > Standard Rectangular Connectors

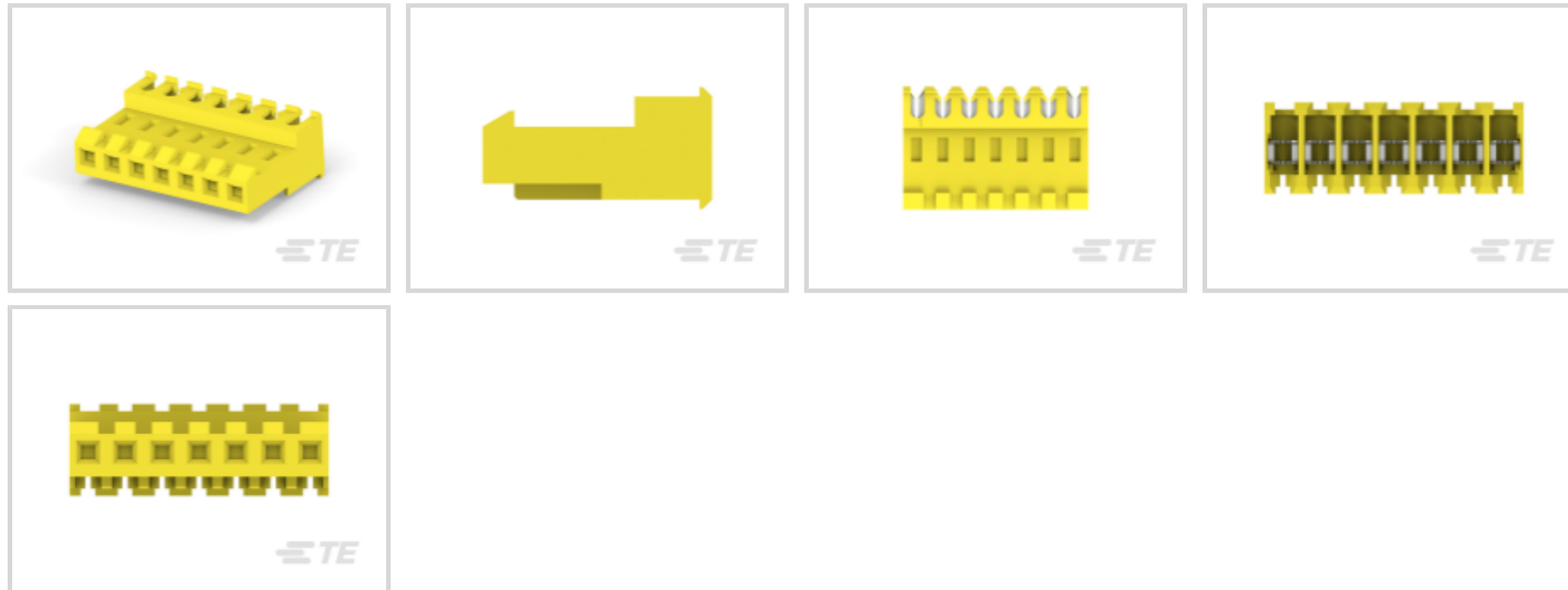

Connector Product Type: **Connector Assembly**

Mating Alignment: **Without**

Connector & Housing Type: **Receptacle**

Mating Retention Type: **Locking Ramp**

Connector System: **Wire-to-Board**

Features

Product Type Features

Compatible With Discrete Wire Type	Stranded
Connector Product Type	Connector Assembly
Connector & Housing Type	Receptacle
Connector System	Wire-to-Board
Insertion Force Type	Normal
Sealable	No
Connector & Contact Terminates To	Wire & Cable

Configuration Features

Number of Cavities	7
Contacts Preloaded	Yes
Number of Positions	7
Number of Rows	1

Electrical Characteristics

Operating Voltage	600 VAC
-------------------	---------



Body Features

Primary Product Color	Yellow
-----------------------	--------

Contact Features

Contact Underplating Material	Nickel
Wire Contact Termination Area Plating Material	Tin
Contact Type	Receptacle
Contact Mating Area Plating Material	Tin (Sn)
Contact Retention Within Housing	With
Contact Current Rating (Max)	7 A

Termination Features

Termination Method to Wire & Cable	Insulation Displacement (IDC)
------------------------------------	-------------------------------

Mechanical Attachment

Contact Retention Type Within Housing	Locking Lance
Mating Alignment	Without
Mating Retention Type	Locking Ramp
Mating Retention	With
Connector Mounting Type	Cable Mount (Free-Hanging)

Housing Features

Housing Material	Nylon
Centerline (Pitch)	3.96 mm[.156 in]

Dimensions

Connector Width	9.78 mm[.385 in]
Connector Height	18.42 mm[.725 in]
Wire Size	20 AWG
Connector Length	27.74 mm[1.092 in]

Usage Conditions

Operating Temperature Range	-55 – 105 °C[-67 – 221 °F]
-----------------------------	----------------------------

Operation/Application

Shielded	No
Circuit Application	Signal

Industry Standards

--	--



Compatible With Agency/Standards Products	CSA, UL
UL Rating	Recognized
Compatible With Approved Standards Products	UL E28476
CSA Rating	LR 7189
UL Flammability Rating	UL 94V-2

Packaging Features

Packaging Quantity	250
Packaging Method	Bag/Box

Product Compliance

[For compliance documentation, visit the product page on TE.com>](#)

EU RoHS Directive 2011/65/EU	Compliant
EU ELV Directive 2000/53/EC	Compliant
China RoHS 2 Directive MIIT Order No 32, 2016	有害物质含量符合标准要求 No Restricted Substance(s) Above Threshold
EU REACH Regulation (EC) No. 1907/2006	Current ECHA Candidate List: JUNE 2025 (250) Candidate List Declared Against: JUNE 2025 (250) Does not contain REACH SVHC
Halogen Content	Low Halogen - Br, Cl, F < 900 ppm per homogenous material. Also BFR/CFR/PVC Free
Solder Process Capability	Not applicable for solder process capability

Product Compliance Disclaimer

This information is provided based on reasonable inquiry of our suppliers and represents our current actual knowledge based on the information they provided. This information is subject to change. The part numbers that TE has identified as EU RoHS compliant have a maximum concentration of 0.1% by weight in homogenous materials for lead, hexavalent chromium, mercury, PBB, PBDE, DBP, BBP, DEHP, DIBP, and 0.01% for cadmium, or qualify for an exemption to these limits as defined in the Annexes of Directive 2011/65/EU (RoHS2). Finished electrical and electronic equipment products will be CE marked as required by Directive 2011/65/EU. Components may not be CE marked. Additionally, the part numbers that TE has identified as EU ELV compliant have a maximum concentration of 0.1% by weight in homogenous materials for lead, hexavalent chromium, and mercury, and 0.01% for cadmium, or qualify for an exemption to these limits as defined in the Annexes of Directive 2000/53/EC (ELV). Regarding the REACH Regulation, the information TE provides on SVHC in articles for this part number is based on the latest European Chemicals Agency (ECHA) 'Guidance on requirements for substances in articles' posted at this URL: <https://echa.europa.eu/guidance-documents/guidance-on-reach>

Compatible Parts



Also in the Series | [MTA 156](#)



Connector Caps & Covers(89)

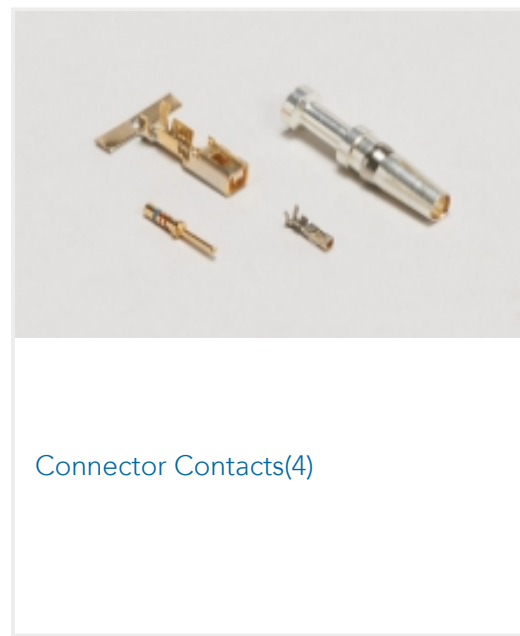

Connector Contacts(4)



Connector Hardware(2)

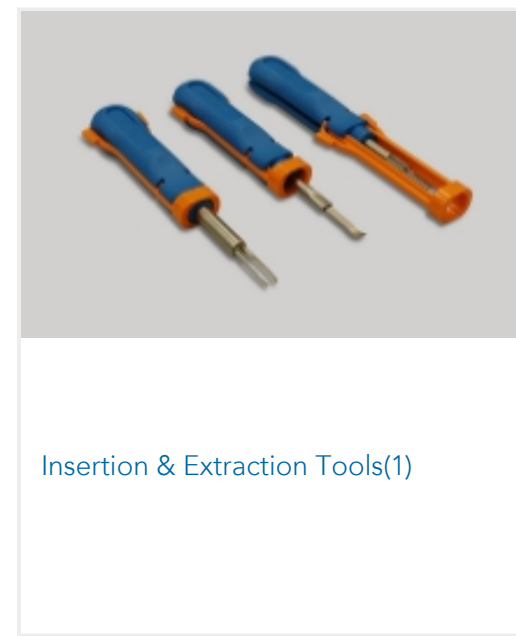

Insertion & Extraction Tools(1)



PCB Headers & Receptacles(677)

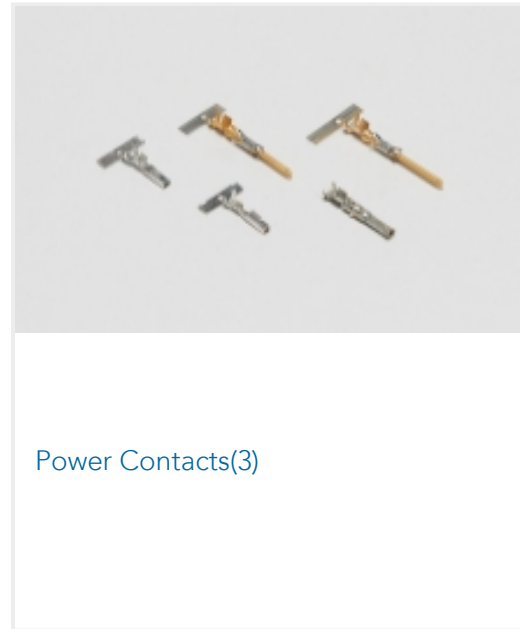

Power Contacts(3)



Rectangular Power Connectors(1178)



Wire-to-Board Headers & Receptacles (677)

Customers Also Bought



TE Part #31807
TERMINAL,SOLIS R 8 10



TE Part #3-640600-2
02P MTA156 CONN ASSY 20AWG LF



TE Part #3-640600-5
05P MTA156 CONN ASSY 20AWG LF

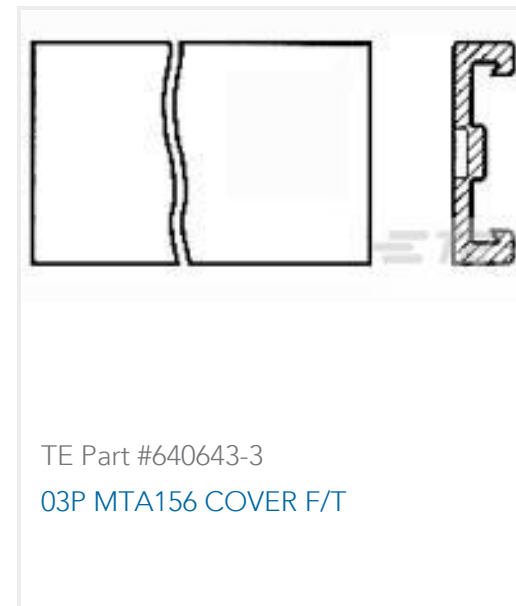

TE Part #640643-3
03P MTA156 COVER F/T

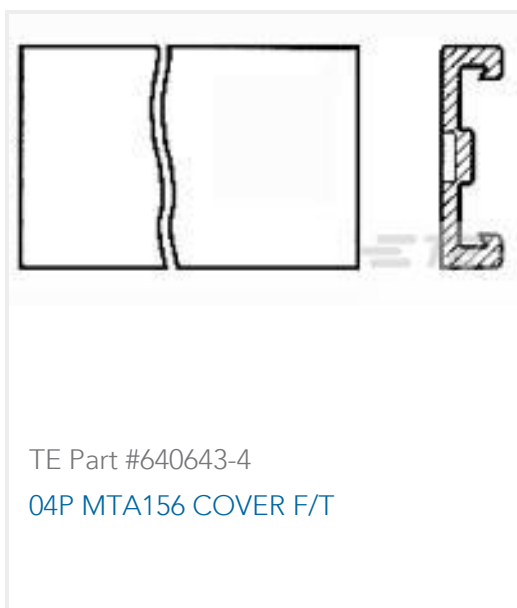

TE Part #640643-4
04P MTA156 COVER F/T

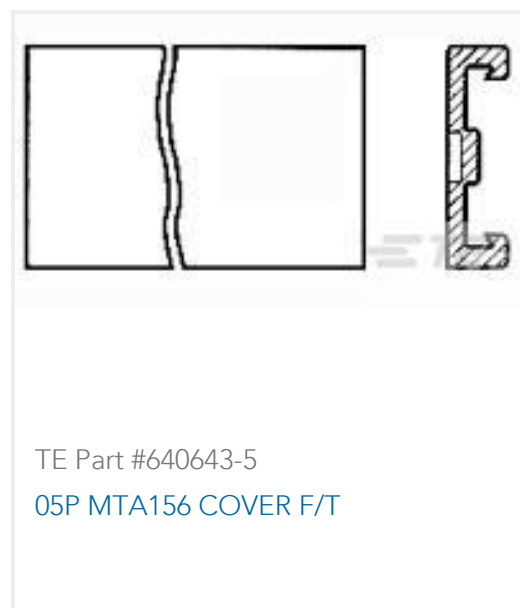

TE Part #640643-5
05P MTA156 COVER F/T



TE Part #3-644466-3
03P MTA156 CONN ASSY 20AWG YEL



TE Part #770246-3
UMNL II PIN PTPPHBZ LP 12-10



TE Part #917981-2
HYBRID MK-2 PLUG HSG ASSY 16P

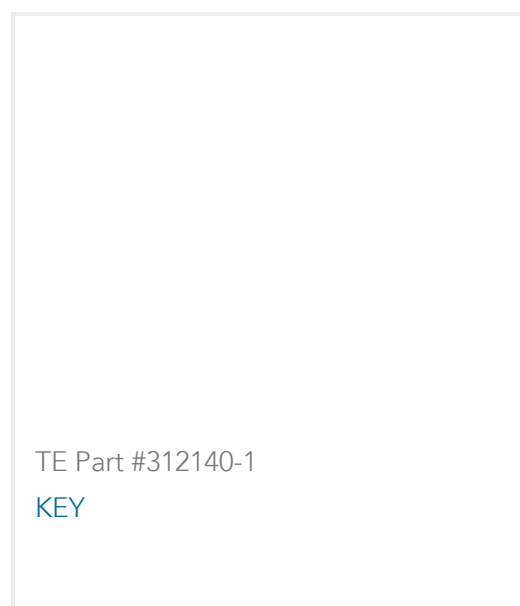

TE Part #312140-1
KEY

Documents



Product Drawings

[07P MTA156 CONN ASSY 20AWG LF](#)

English

CAD Files

[3D PDF](#)

3D

Customer View Model

[ENG_CVM_CVM_3-640600-7_S.2d_dxf.zip](#)

English

Customer View Model

[ENG_CVM_CVM_3-640600-7_S.3d_igs.zip](#)

English

Customer View Model

[ENG_CVM_CVM_3-640600-7_S.3d_stp.zip](#)

English

By downloading the CAD file I accept and agree to the [Terms and Conditions](#) of use.

Product Specifications

[Application Specification](#)

English

[Application Specification](#)

Japanese

[Application Specification](#)

English

[MTA 156 Ribbon Cable Connector Assemblies \(English And Spanish\)](#)

English

[MTA 156 Ribbon Cable Connector Assemblies \(English And Spanish\)](#)

Japanese

Agency Approvals

[Agency Approval Document](#)

English