

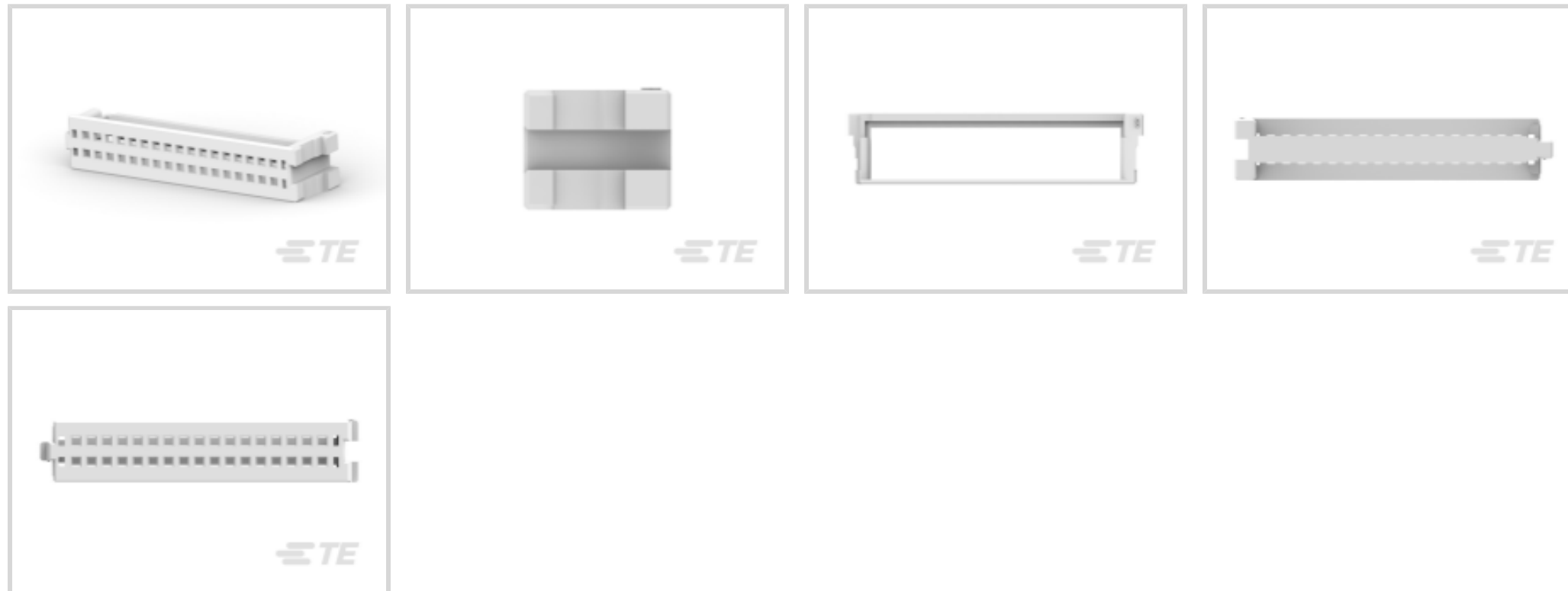

Connectors > Connector Accessories > Connector Hardware



Connector Hardware Accessory Type: **Holder**

Primary Product Color: **Natural**

Number of Positions: **34**

Operating Temperature (Max): **105 °C [221 °F]**

Operating Temperature Range: **-30 – 105 °C [-22 – 221 °F]**

Features

Industry Standards

UL Flammability Rating	UL 94V-0
------------------------	----------

Housing Features

Centerline (Pitch)	1.5 mm [.059 in]
--------------------	------------------

Packaging Features

Packaging Method	Box
Packaging Quantity	400

Product Type Features

Connector Hardware Accessory Type	Holder
Hardware Accessory Function	Mounting

Configuration Features

Number of Positions	34
---------------------	----

Body Features

Primary Product Color	Natural
-----------------------	---------

Usage Conditions

--	--



Operating Temperature (Max)	105 °C[221 °F]
Operating Temperature Range	-30 – 105 °C[-22 – 221 °F]

Other

EU RoHS Compliance	Compliant
EU ELV Compliance	Compliant

Product Compliance

[For compliance documentation, visit the product page on TE.com>](#)

EU RoHS Directive 2011/65/EU	Compliant
EU ELV Directive 2000/53/EC	Compliant
China RoHS 2 Directive MIIT Order No 32, 2016	No Restricted Materials Above Threshold
EU REACH Regulation (EC) No. 1907/2006	Current ECHA Candidate List: JUNE 2024 (241) Candidate List Declared Against: JUNE 2024 (241) Does not contain REACH SVHC
Halogen Content	Low Halogen - Br, Cl, F, I < 900 ppm per homogenous material. Also BFR/CFR/PVC Free
Solder Process Capability	Not applicable for solder process capability

Product Compliance Disclaimer

This information is provided based on reasonable inquiry of our suppliers and represents our current actual knowledge based on the information they provided. This information is subject to change. The part numbers that TE has identified as EU RoHS compliant have a maximum concentration of 0.1% by weight in homogenous materials for lead, hexavalent chromium, mercury, PBB, PBDE, DBP, BBP, DEHP, DIBP, and 0.01% for cadmium, or qualify for an exemption to these limits as defined in the Annexes of Directive 2011/65/EU (RoHS2). Finished electrical and electronic equipment products will be CE marked as required by Directive 2011/65/EU. Components may not be CE marked. Additionally, the part numbers that TE has identified as EU ELV compliant have a maximum concentration of 0.1% by weight in homogenous materials for lead, hexavalent chromium, and mercury, and 0.01% for cadmium, or qualify for an exemption to these limits as defined in the Annexes of Directive 2000/53/EC (ELV). Regarding the REACH Regulation, the information TE provides on SVHC in articles for this part number is based on the latest European Chemicals Agency (ECHA) 'Guidance on requirements for substances in articles' posted at this URL: <https://echa.europa.eu/guidance-documents/guidance-on-reach>

Compatible Parts

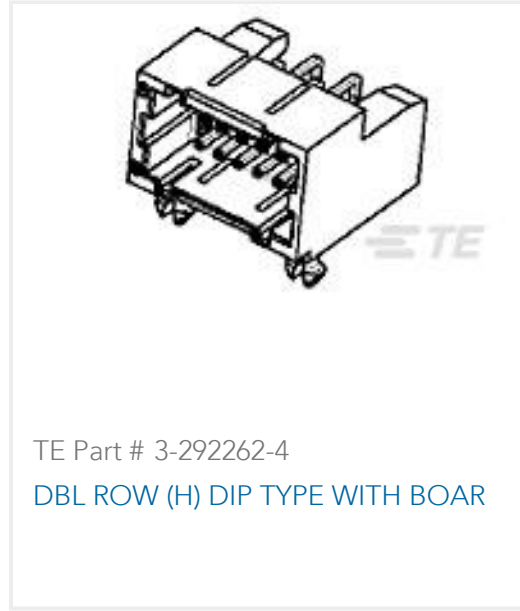
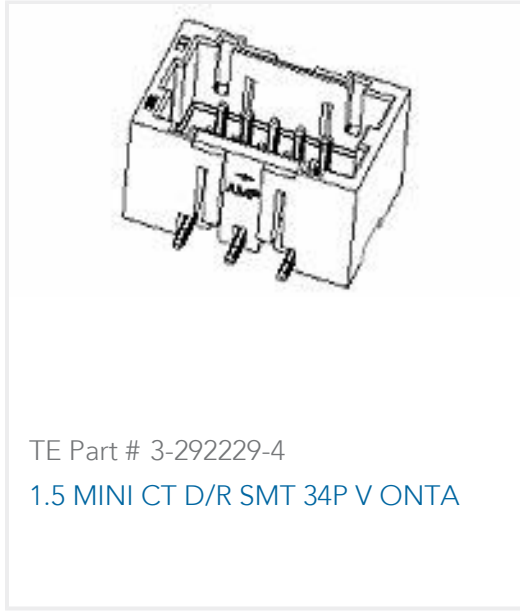

Also in the Series | AMP Mini CT

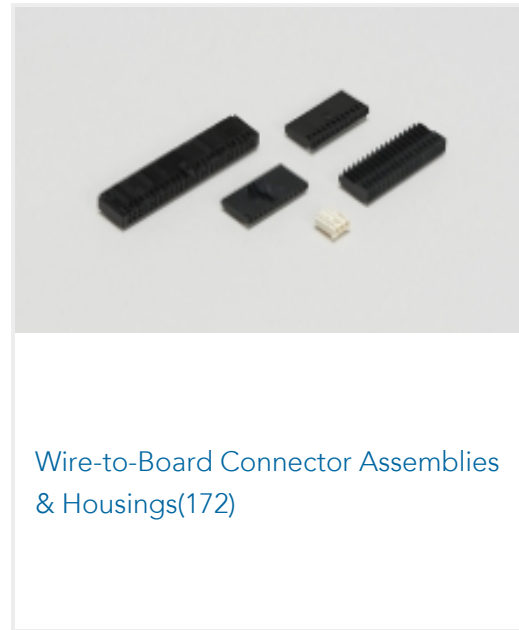
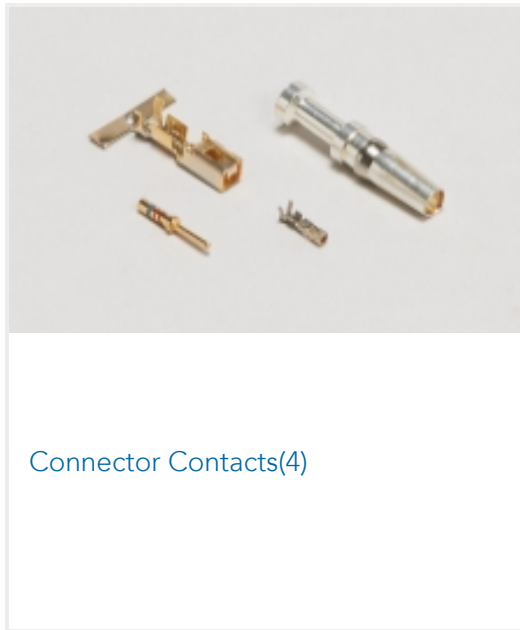

Customers Also Bought





Documents

Product Drawings

[AMP MINI D/R HDR HSG 34P NATU](#)

English

CAD Files

[3D PDF](#)

English

Customer View Model

[ENG_CVM_3-353294-4_E.3d_igs.zip](#)

English

Customer View Model

[ENG_CVM_3-353294-4_E.3d_stp.zip](#)

English

Customer View Model

[ENG_CVM_3-353294-4_E.2d_dxf.zip](#)

English

By downloading the CAD file I accept and agree to the [Terms and Conditions](#) of use.

Product Specifications

[Application Specification](#)

English