



### Product Compliance

[For compliance documentation, visit the product page on TE.com>](#)

EU RoHS Directive 2011/65/EU	Compliant
EU ELV Directive 2000/53/EC	Compliant
China RoHS 2 Directive MIIT Order No 32, 2016	有害物质含量符合标准要求 No Restricted Substance(s) Above Threshold
EU REACH Regulation (EC) No. 1907/2006	Current ECHA Candidate List: JUNE 2025 (250) Candidate List Declared Against: JAN 2025 (247) Does not contain REACH SVHC
Halogen Content	BFR/CFR/PVC Free, but Br/Cl >900 ppm in other sources.
Solder Process Capability	Not reviewed for solder process capability

#### Product Compliance Disclaimer

This information is provided based on reasonable inquiry of our suppliers and represents our current actual knowledge based on the information they provided. This information is subject to change. The part numbers that TE has identified as EU RoHS compliant have a maximum concentration of 0.1% by weight in homogenous materials for lead, hexavalent chromium, mercury, PBB, PBDE, DBP, BBP, DEHP, DIBP, and 0.01% for cadmium, or qualify for an exemption to these limits as defined in the Annexes of Directive 2011/65/EU (RoHS2). Finished electrical and electronic equipment products will be CE marked as required by Directive 2011/65/EU. Components may not be CE marked. Additionally, the part numbers that TE has identified as EU ELV compliant have a maximum concentration of 0.1% by weight in homogenous materials for lead, hexavalent chromium, and mercury, and 0.01% for cadmium, or qualify for an exemption to these limits as defined in the Annexes of Directive 2000/53/EC (ELV). Regarding the REACH Regulation, the information TE provides on SVHC in articles for this part number is based on the latest European Chemicals Agency (ECHA) 'Guidance on requirements for substances in articles' posted at this URL: <https://echa.europa.eu/guidance-documents/guidance-on-reach>

### Compatible Parts



TE Part # 1-2141154-2  
2POS,8MM HV,REC HSG,90DEG,ASSY,SEALED



TE Part # 2141153-1  
LEVER,2POS,90DEG



TE Part # 2141156-5  
SINGLE WIRE SEAL,8MM HV,90DEG

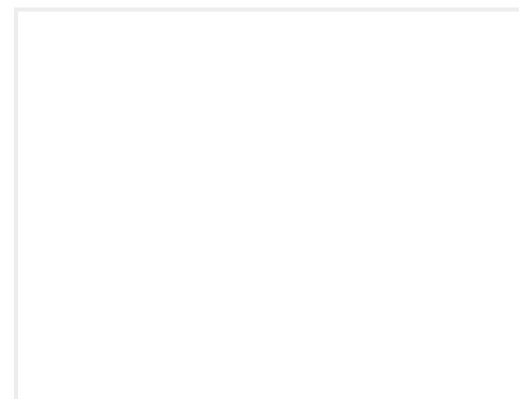

TE Part # 2177597-1  
INSULATION INSERT,SLEEVE,ASSY



TE Part # 2141155-1  
PROTEC. COVER 8MM HV,90DEG

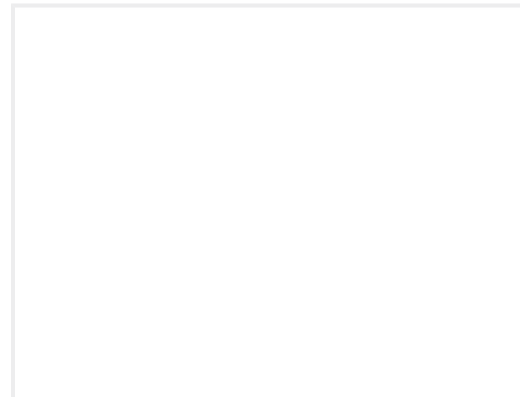

TE Part # 2141147-2  
2POS,8MM HV,REC HSG,90DEG,SEALED



TE Part # 9-2141158-2  
CU ALLOY,SHIELD,8MM HV,CONN HSG,90 DEG

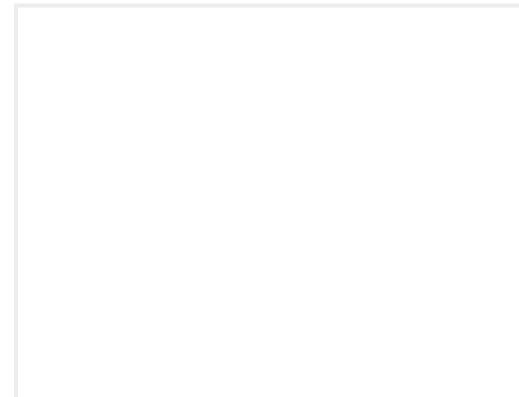

TE Part # 2208243-1  
CPA,HVP 800

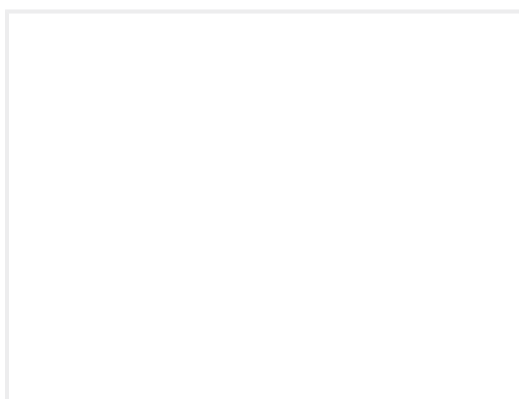

TE Part # 2208242-1  
CPA, ADAPTER, HVP800

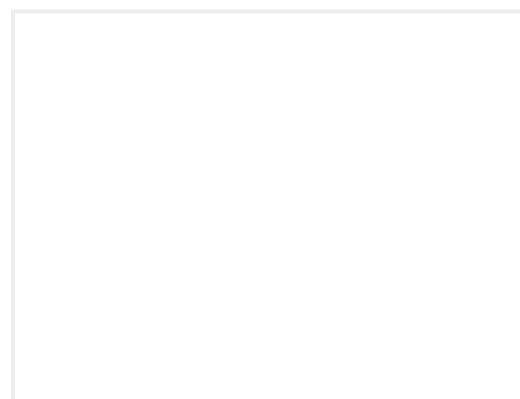

TE Part # 2177596-1  
INSULATION INSERT,SHIELDING,ASSY



TE Part # 2141156-1  
SWS,8MM HV,WHT,50 SQMM

### Customers Also Bought



TE Part #CAT-D48-ST273  
DEUTSCH Connector Solid Contacts



TE Part #CAT-D487-W416  
Wedglocks: DEUTSCH DT



TE Part #DT04-2P  
REC, 2P, GRY, N



TE Part #DT06-2S  
PLG, 2P, GRY, N



TE Part #206070-8  
CABLE CLAMP KIT #17

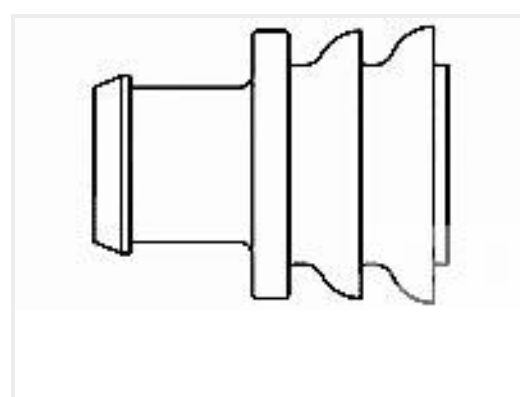

TE Part #281934-2  
SINGLE WIRE SEAL



TE Part #CAT-AM71-CH8172  
AMP SUPERSEAL 1.5MM, CONNECTOR HOUSING

### Documents



### Product Drawings

2POS,8MM HV,REC HSG,90DEG,ASSY,SEALED

English

---

### CAD Files

3D PDF

3D

Customer View Model

[ENG\\_CVM\\_CVM\\_3-2286713-2\\_A.2d\\_dxf.zip](#)

English

Customer View Model

[ENG\\_CVM\\_CVM\\_3-2286713-2\\_A.3d\\_igs.zip](#)

English

Customer View Model

[ENG\\_CVM\\_CVM\\_3-2286713-2\\_A.3d\\_stp.zip](#)

English

By downloading the CAD file I accept and agree to the [Terms and Conditions](#) of use.

---

### Product Specifications

[Application Specification](#)

English