

8136-652P4 ✓ ACTIVE

Alcoswitch | Alcoswitch DIP, Alcoswitch DIP JUMPER PLUG

TE Internal #: 3-1437507-0

DIP Switch, Black, Polyester, -65 – 125 °C, Single Pole - Single Throw Configuration (Pole-Throw), 500 VDC, 2.54 mm [.1 in] Centerline, Alcoswitch DIP

[View on TE.com >](#)



Switches > DIP & SIP Switches

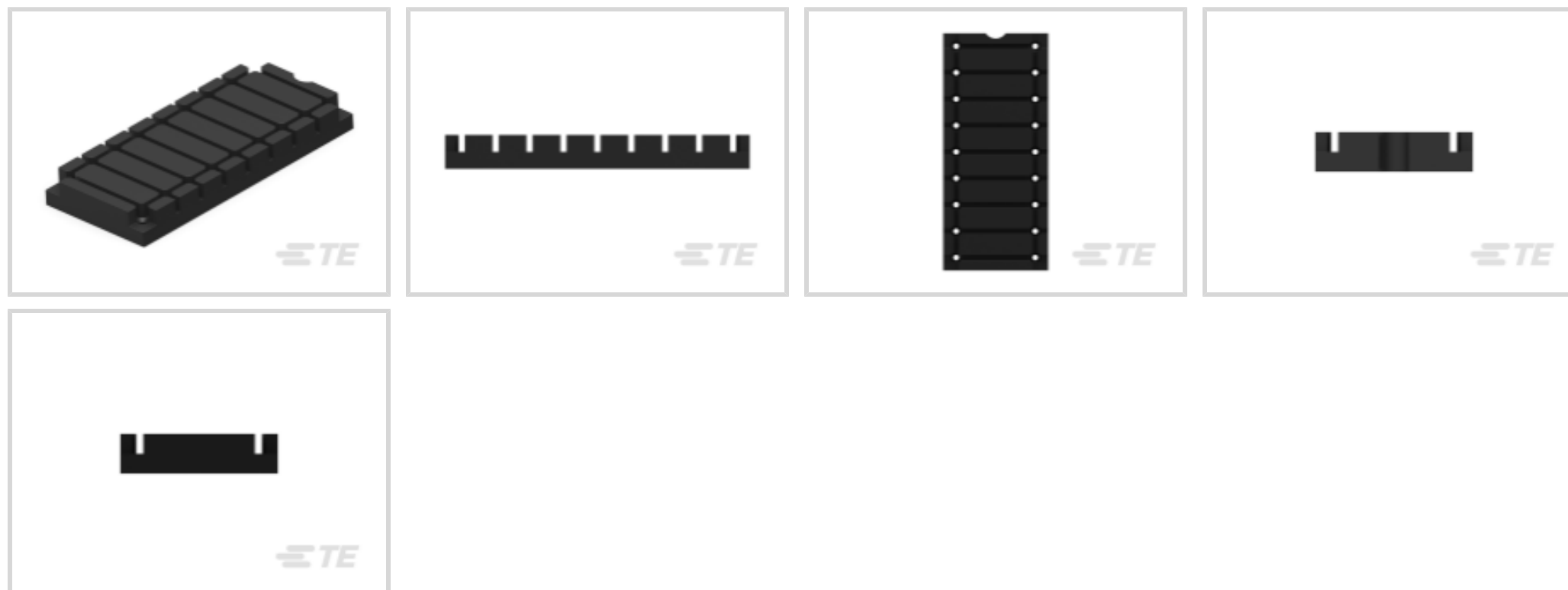

DIP & SIP Switch Type: **DIP**

Case Color: **Black**

Case Material: **Polyester**

Sealed Device: **No**

Operating Temperature Range: **-65 – 125 °C**

Features

Product Type Features

| | |
|-----------------------|-----|
| DIP & SIP Switch Type | DIP |
| Sealed Device | No |

Body Features

| | |
|---------------|-----------|
| Case Color | Black |
| Case Material | Polyester |

Usage Conditions

| | |
|-----------------------------|--------------|
| Operating Temperature Range | -65 – 125 °C |
|-----------------------------|--------------|

Configuration Features

| | |
|----------------------------|----------------------------|
| Configuration (Pole-Throw) | Single Pole - Single Throw |
|----------------------------|----------------------------|

Electrical Characteristics

| | |
|-------------------|---------|
| Operating Voltage | 500 VDC |
|-------------------|---------|

Housing Features

| | |
|--------------------|-----------------|
| Centerline (Pitch) | 2.54 mm [.1 in] |
|--------------------|-----------------|



Contact Features

| | |
|-----------------------|-----------------|
| Contact Base Material | Phosphor Bronze |
|-----------------------|-----------------|

Other

| | |
|--------------------|-----------|
| EU RoHS Compliance | Compliant |
| EU ELV Compliance | Compliant |

Product Compliance

[For compliance documentation, visit the product page on TE.com>](#)

| | |
|---|---|
| EU RoHS Directive 2011/65/EU | Compliant |
| EU ELV Directive 2000/53/EC | Compliant |
| China RoHS 2 Directive MIIT Order No 32, 2016 | No Restricted Materials Above Threshold |
| EU REACH Regulation (EC) No. 1907/2006 | Current ECHA Candidate List: JUNE 2024 (241) Candidate List Declared Against: JUNE 2024 (241) Does not contain REACH SVHC |
| Halogen Content | Not Low Halogen - contains Br or Cl > 900 ppm. |
| Solder Process Capability | Wave solder capable to 265°C |

Product Compliance Disclaimer

This information is provided based on reasonable inquiry of our suppliers and represents our current actual knowledge based on the information they provided. This information is subject to change. The part numbers that TE has identified as EU RoHS compliant have a maximum concentration of 0.1% by weight in homogenous materials for lead, hexavalent chromium, mercury, PBB, PBDE, DBP, BBP, DEHP, DIBP, and 0.01% for cadmium, or qualify for an exemption to these limits as defined in the Annexes of Directive 2011/65/EU (RoHS2). Finished electrical and electronic equipment products will be CE marked as required by Directive 2011/65/EU. Components may not be CE marked. Additionally, the part numbers that TE has identified as EU ELV compliant have a maximum concentration of 0.1% by weight in homogenous materials for lead, hexavalent chromium, and mercury, and 0.01% for cadmium, or qualify for an exemption to these limits as defined in the Annexes of Directive 2000/53/EC (ELV). Regarding the REACH Regulations, TE's information on SVHC in articles for this part number is still based on the European Chemical Agency (ECHA) 'Guidance on requirements for substances in articles' (Version: 2, April 2011), applying the 0.1% weight on weight concentration threshold at the finished product level. TE is aware of the European Court of Justice ruling of September 10th, 2015 also known as O5A (Once An Article Always An Article) stating that, in case of 'complex object', the threshold for a SVHC must be applied to both the product as a whole and simultaneously to each of the articles forming part of its composition. TE has evaluated this ruling based on the new ECHA "Guidance on requirements for substances in articles" (June 2017, version 4.0) and will be updating its statements accordingly.

Compatible Parts



Also in the Series | Alcoswitch DIP

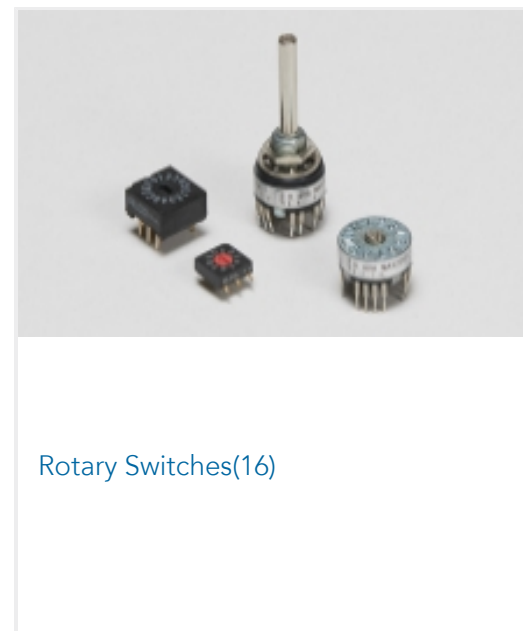
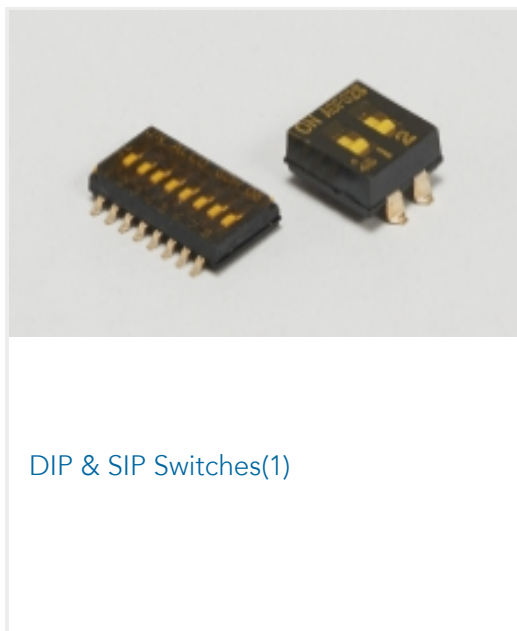

Also in the Series | Alcoswitch DIP JUMPER PLUG

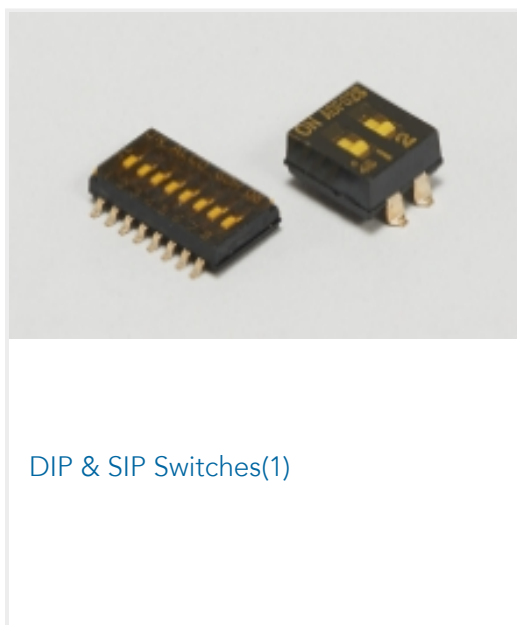

Customers Also Bought

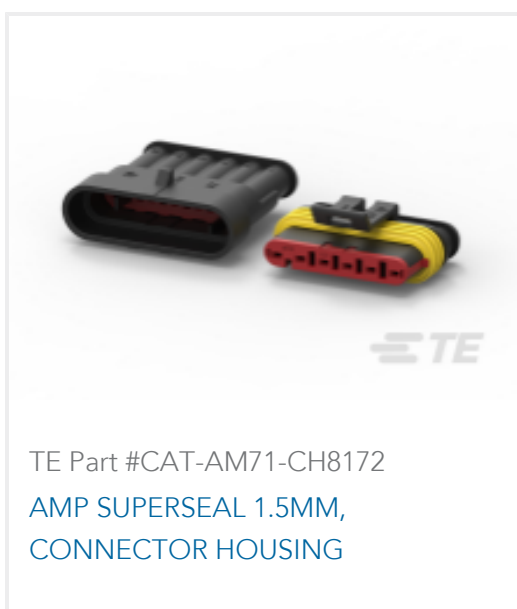

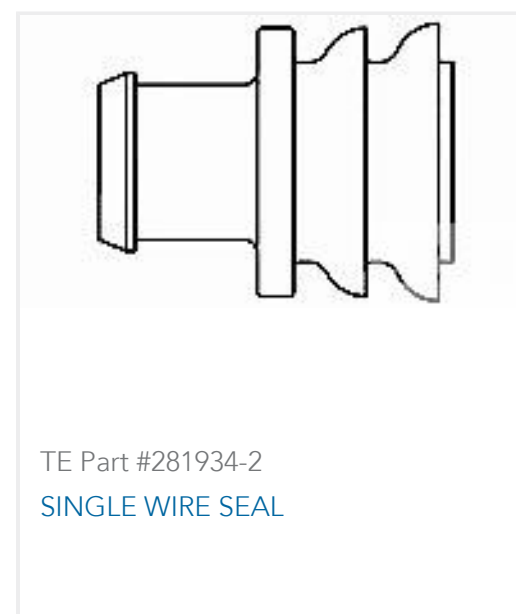
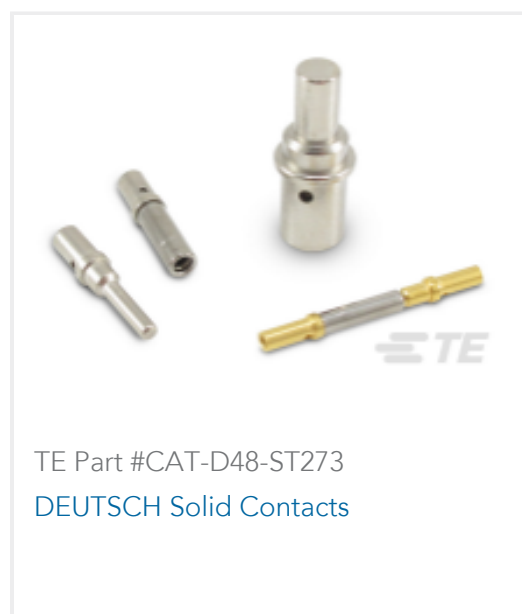

Documents

CAD Files

3D PDF

3D

Customer View Model

[ENG_CVM_CVM_3-1437507-0_A_c-3-1437507-0-a.2d_dxf.zip](#)

English

Customer View Model

[ENG_CVM_CVM_3-1437507-0_A_c-3-1437507-0-a.3d_igs.zip](#)

English

Customer View Model

[ENG_CVM_CVM_3-1437507-0_A_c-3-1437507-0-a.3d_stp.zip](#)

English

By downloading the CAD file I accept and agree to the [Terms and Conditions](#) of use.

Datasheets & Catalog Pages

[SWITCHES_CORE_PROGRAM_CATALOG](#)

English