

2842114-4 ✓ ACTIVE

AMPMODU | AMPMODU 2 mm

TE Internal #: 2842114-4

PCB Mount Header, Right Angle, Board-to-Board, 4 Position, 2 mm

[.079 in] Centerline, Breakaway, Gold, Through Hole - Solder,

Signal, AMPMODU 2 mm

[View on TE.com >](#)



Connectors > PCB Connectors > PCB Headers & Receptacles

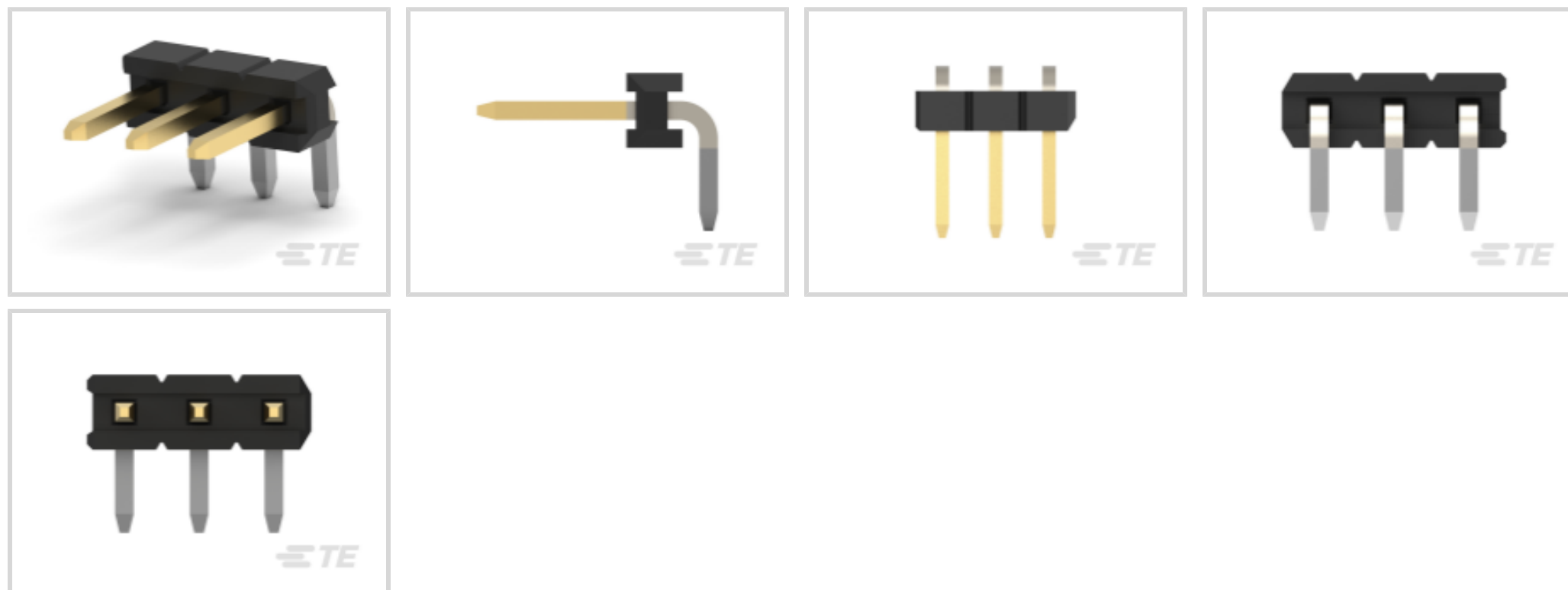

PCB Connector Assembly Type: **PCB Mount Header**

PCB Mount Orientation: **Right Angle**

Connector System: **Board-to-Board**

Number of Positions: **4**

Number of Rows: **1**

Features

Electrical Characteristics

Operating Voltage	125 VAC
Dielectric Withstanding Voltage (Max)	500 VAC

Dimensions

Connector Width	2 mm[.079 in]
PCB Thickness (Recommended)	1.6 mm[.063 in]
Connector Length	8 mm[.315 in]

Industry Standards

Compatible With Agency/Standards Products	UL
UL Rating	Recognized
Compatible With Approved Standards Products	UL E28476
UL Flammability Rating	UL 94V-0

Usage Conditions

Housing Temperature Rating	High
Operating Temperature Range	-40 – 125 °C[-40 – 257 °F]



Body Features

Assembly Process Feature Material	Thermoplastic
Connector Profile	Standard
Primary Product Color	Black

Operation/Application

Assembly Process Feature	Pick and Place Cover, Plastic Cap
Circuit Application	Signal

Termination Features

Termination Post & Tail Length	2.8 mm[.11 in]
Square Termination Post & Tail Dimension	.5 mm[.02 in]
Termination Method to PCB	Through Hole - Solder

Contact Features

Contact Underplating Material	Nickel
Contact Underplating Material Thickness	.5 μm [19.69 μin]
PCB Contact Termination Area Plating Material Finish	Bright
Contact Mating Area Plating Material Thickness	.1 μm [3.94 μin]
Mating Square Post Dimension	.5 mm[.02 in]
Contact Shape & Form	Square
PCB Contact Termination Area Plating Material Thickness	2 μm [78.74 μin]
Contact Layout	Inline
Contact Mating Area Length	4 mm[.157 in]
Contact Base Material	Brass
PCB Contact Termination Area Plating Material	Tin
Contact Mating Area Plating Material	Gold
Contact Type	Pin
Contact Current Rating (Max)	2 A

Housing Features

Housing Material	PA9T GF
Centerline (Pitch)	2 mm[.079 in]

Configuration Features

Stackable	No
PCB Mount Orientation	Right Angle



Number of Positions	4
Number of Rows	1

Product Type Features

PCB Connector Assembly Type	PCB Mount Header
Connector System	Board-to-Board
Header Type	Breakaway
Connector & Contact Terminates To	Printed Circuit Board

Packaging Features

Packaging Method	Tube
------------------	------

Other

EU RoHS Compliance	Compliant
EU ELV Compliance	Compliant

Product Compliance

[For compliance documentation, visit the product page on TE.com>](#)

EU RoHS Directive 2011/65/EU	Compliant
EU ELV Directive 2000/53/EC	Compliant
China RoHS 2 Directive MIIT Order No 32, 2016	No Restricted Materials Above Threshold
EU REACH Regulation (EC) No. 1907/2006	Current ECHA Candidate List: JUNE 2024 (241) Candidate List Declared Against: JUNE 2024 (241) Does not contain REACH SVHC
Halogen Content	Not Low Halogen - contains Br or Cl > 900 ppm.
Solder Process Capability	Reflow solder capable to 260°C

Product Compliance Disclaimer

This information is provided based on reasonable inquiry of our suppliers and represents our current actual knowledge based on the information they provided. This information is subject to change. The part numbers that TE has identified as EU RoHS compliant have a maximum concentration of 0.1% by weight in homogenous materials for lead, hexavalent chromium, mercury, PBB, PBDE, DBP, BBP, DEHP, DIBP, and 0.01% for cadmium, or qualify for an exemption to these limits as defined in the Annexes of Directive 2011/65/EU (RoHS2). Finished electrical and electronic equipment products will be CE marked as required by Directive 2011/65/EU. Components may not be CE marked. Additionally, the part numbers that TE has identified as EU ELV compliant have a maximum concentration of 0.1% by weight in homogenous materials for lead, hexavalent chromium, and mercury, and 0.01% for cadmium, or qualify for an exemption to these limits as defined in the Annexes of Directive 2000/53/EC (ELV). Regarding the REACH Regulation, the information TE provides on SVHC in articles for this part number is based on the latest European Chemicals Agency (ECHA) 'Guidance on requirements for substances in articles' posted at this URL: <https://echa.europa.eu/guidance-documents/guidance-on-reach>

Compatible Parts



TE Part # 2314848-4
4P,2MM,BB,REC,SRVT,SMD,0.1AU,TB,W/CP

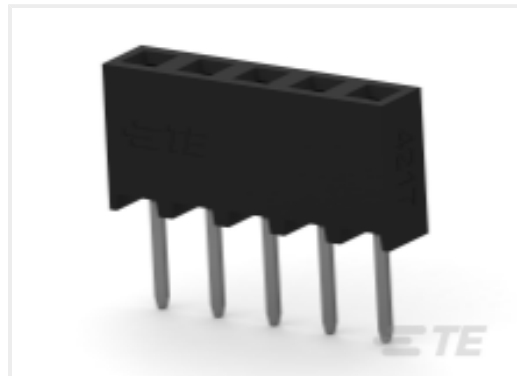

TE Part # 2307768-4
4P,2MM,BB,REC,SRVT,2.7,0.1AU,TR,W/CP

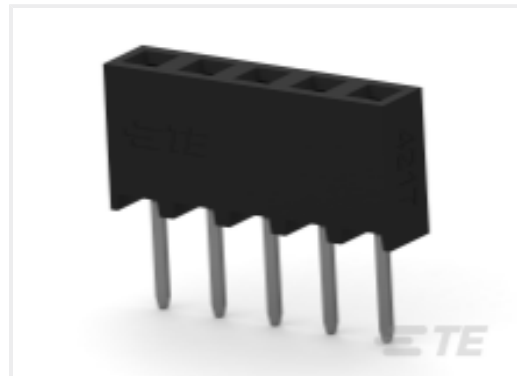

TE Part # 2307769-4
4P,2MM,B-B,REC,SRVT,3.2,0.1AU,TUBE

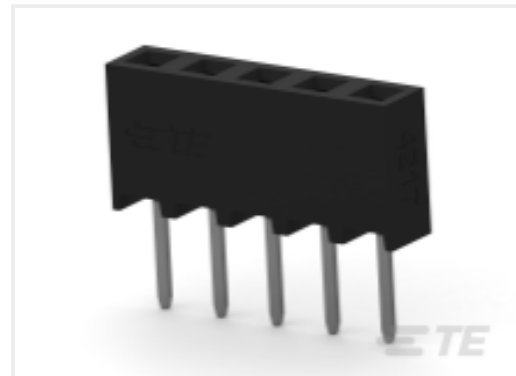

TE Part # 2307767-4
4P,2MM,BB,REC,SRVT,2.0,0.1AU,TR,W/CP



TE Part # 2317204-4
4P,2MM,REC,IDC,PLAIN,26-30,STRIP,Au0.1



TE Part # 2316102-4
4P,2MM,REC,HSG,SR,CRIMP,PLAIN,BOX

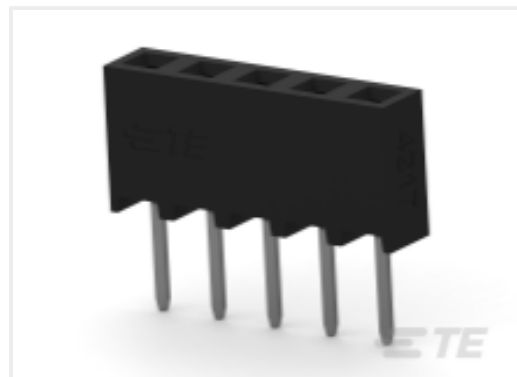

TE Part # 2314880-4
4P,2MM,BB,REC,SRVT,2.7,0.1AU,TB,W/CP

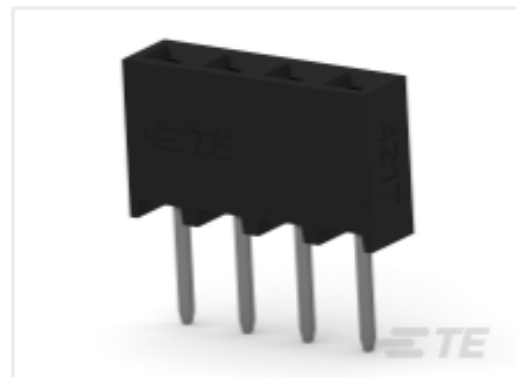

TE Part # 2314868-4
4P,2MM,BB,REC,SRVT,2.0,0.1AU,TB,W/CP



TE Part # 2307813-4
4P,2MM,BB,REC,SRVT,SMD,0.1AU,TR,W/CP

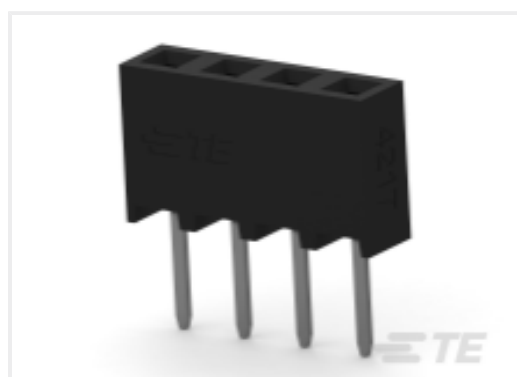

TE Part # 2314876-4
4P,2MM,B-B,REC,SRVT,2.7,0.1AU,TB

Also in the Series | AMPMODU 2 mm



Board-to-Board Headers & Receptacles(8161)



Connector Contacts(27)

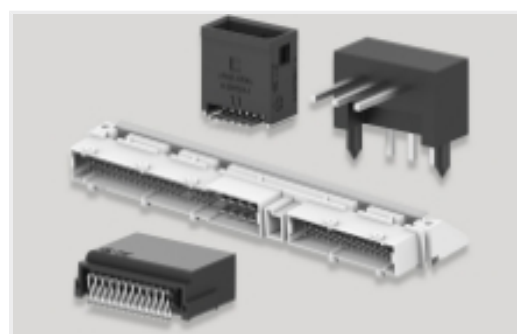

PCB Headers & Receptacles(8190)

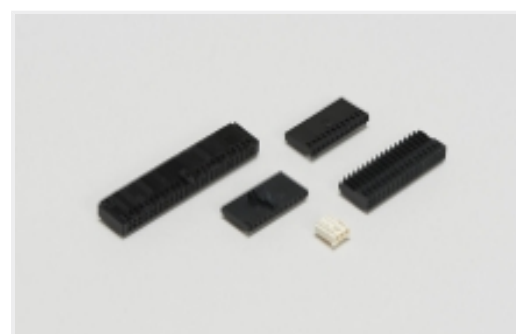

Wire-to-Board Connector Assemblies & Housings(202)

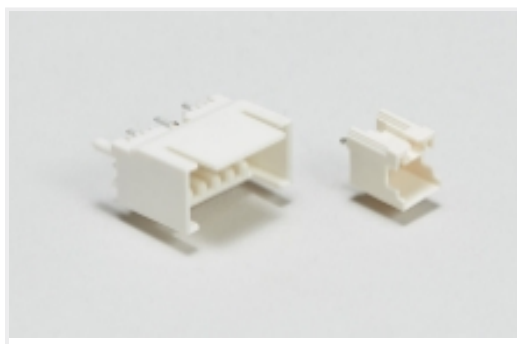
Wire-to-Board Headers & Receptacles
(1037)

Customers Also Bought

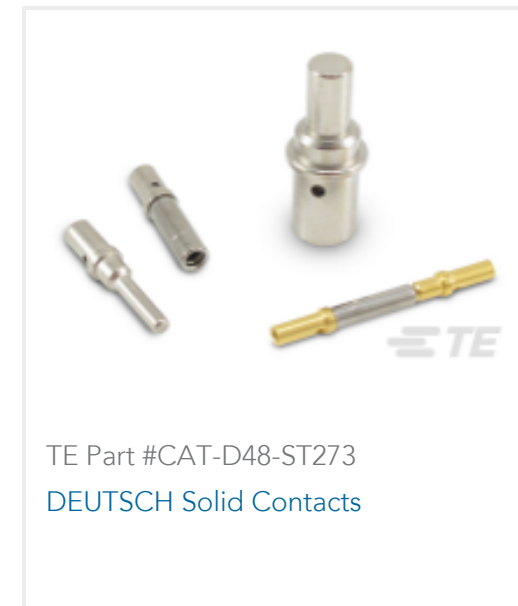
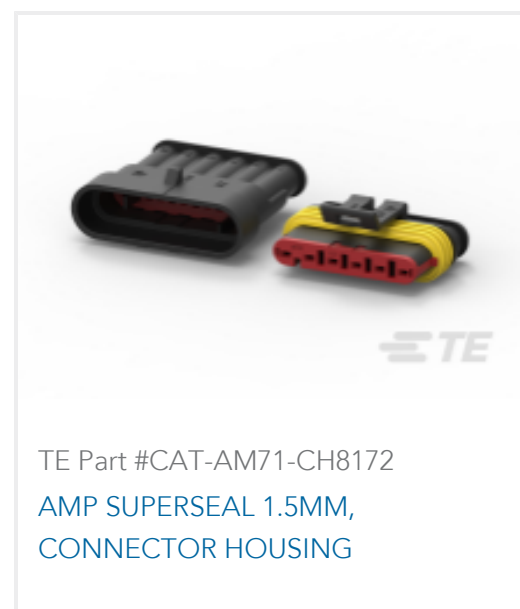
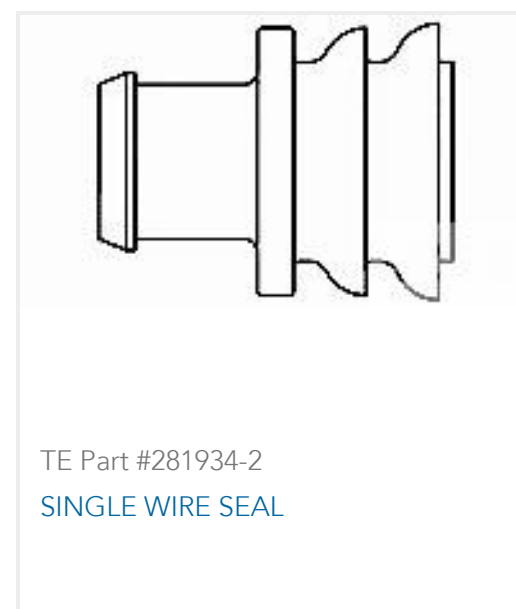
TE Part #DT04-2P
REC, 2P, GRY, NTE Part #DT06-2S
PLG, 2P, GRY, NTE Part #CAT-D487-W416
Wedgelocks: DEUTSCH DTTE Part #CAT-D48-ST273
DEUTSCH Solid ContactsTE Part #114017-ZZ
SEALING PLUG, SIZE 12/16, WHTTE Part #CAT-AM71-CH8172
AMP SUPERSEAL 1.5MM,
CONNECTOR HOUSINGTE Part #281934-2
SINGLE WIRE SEAL

Documents

CAD Files

3D PDF

3D

Customer View Model

[ENG_CVM_CVM_2842114-4_A.2d_dxf.zip](#)

English

Customer View Model

[ENG_CVM_CVM_2842114-4_A.3d_igs.zip](#)

English

Customer View Model

[ENG_CVM_CVM_2842114-4_A.3d_stp.zip](#)

English

By downloading the CAD file I accept and agree to the [Terms and Conditions](#) of use.

Product Specifications

Application Specification

English

2842114-4

PCB Mount Header, Right Angle, Board-to-Board, 4 Position, 2 mm [.079 in]
Centerline, Breakaway, Gold, Through Hole - Solder, Signal, AMPMODU 2 mm

