

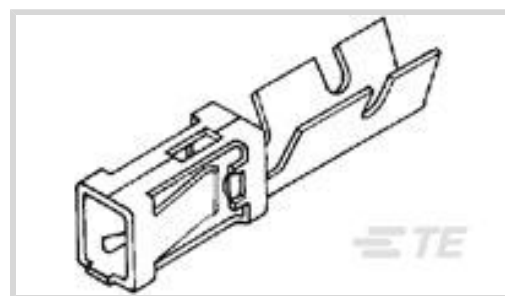

Connectors > Contacts > Connector Contacts



Contact Type: **Socket**

Contact Mating Area Plating Material: **Tin**

Wire Size: **.5 – 1 mm<sup>2</sup>**

Contact Base Material: **Phosphor Bronze**

## Features

### Product Type Features

Applied Pressure	High
------------------	------

### Mechanical Attachment

Wire Insulation Support	With
PCB Mount Retention	Without

### Packaging Features

Packaging Method	Reel
Packaging Quantity	5000

### Dimensions

Compatible Insulation Diameter Range	2.2 – 2.8 mm [.086 – .11 in]
Wire Size	.5 – 1 mm <sup>2</sup>

### Contact Features

PCB Contact Termination Area Plating Material Thickness	.8 μm [31.496 μin]
Contact Orientation	Straight
PCB Contact Termination Area Plating Material	Tin
Contact Mating Area Plating Material Thickness	.8 μm [31.496 μin]
Contact Type	Socket
Contact Mating Area Plating Material	Tin
Contact Base Material	Phosphor Bronze
Contact Current Rating (Max)	5 A



### Termination Features

Product Terminates To	Wire & Cable
-----------------------	--------------

### Usage Conditions

Operating Temperature Range	-40 – 105 °C[-40 – 221 °F]
-----------------------------	----------------------------

### Operation/Application

Circuit Application	Signal
---------------------	--------

### Other

EU RoHS Compliance	Compliant
EU ELV Compliance	Compliant

### Product Compliance

[For compliance documentation, visit the product page on TE.com>](#)

EU RoHS Directive 2011/65/EU	Compliant
EU ELV Directive 2000/53/EC	Compliant
China RoHS 2 Directive MIIT Order No 32, 2016	No Restricted Materials Above Threshold
EU REACH Regulation (EC) No. 1907/2006	Current ECHA Candidate List: JUNE 2024 (241) Candidate List Declared Against: JUNE 2024 (241) Does not contain REACH SVHC
Halogen Content	Low Halogen - Br, Cl, F, I < 900 ppm per homogenous material. Also BFR/CFR/PVC Free
Solder Process Capability	Not applicable for solder process capability

#### Product Compliance Disclaimer

This information is provided based on reasonable inquiry of our suppliers and represents our current actual knowledge based on the information they provided. This information is subject to change. The part numbers that TE has identified as EU RoHS compliant have a maximum concentration of 0.1% by weight in homogenous materials for lead, hexavalent chromium, mercury, PBB, PBDE, DBP, BBP, DEHP, DIBP, and 0.01% for cadmium, or qualify for an exemption to these limits as defined in the Annexes of Directive 2011/65/EU (RoHS2). Finished electrical and electronic equipment products will be CE marked as required by Directive 2011/65/EU. Components may not be CE marked. Additionally, the part numbers that TE has identified as EU ELV compliant have a maximum concentration of 0.1% by weight in homogenous materials for lead, hexavalent chromium, and mercury, and 0.01% for cadmium, or qualify for an exemption to these limits as defined in the Annexes of Directive 2000/53/EC (ELV). Regarding the REACH Regulation, the information TE provides on SVHC in articles for this part number is based on the latest European Chemicals Agency (ECHA) 'Guidance on requirements for substances in articles' posted at this URL: <https://echa.europa.eu/guidance-documents/guidance-on-reach>

### Compatible Parts



## Also in the Series | AMPMODU MOD 1

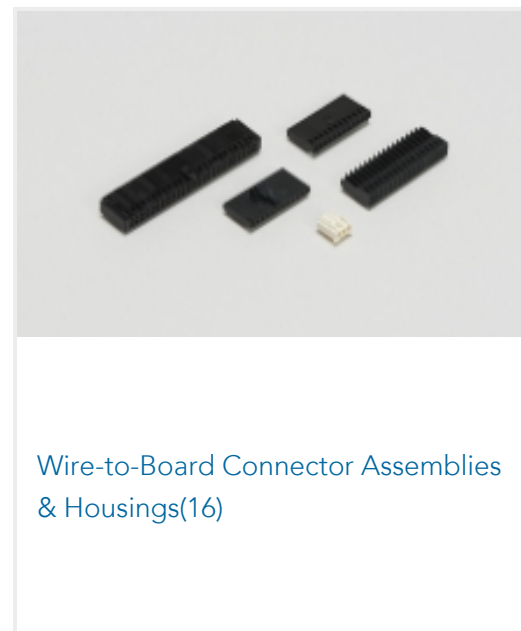
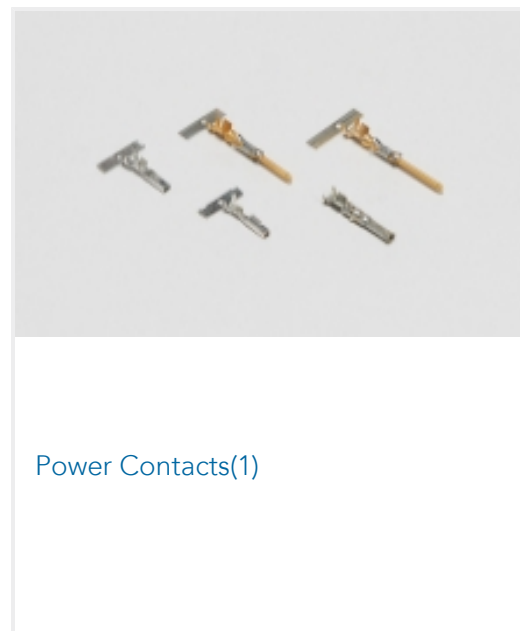
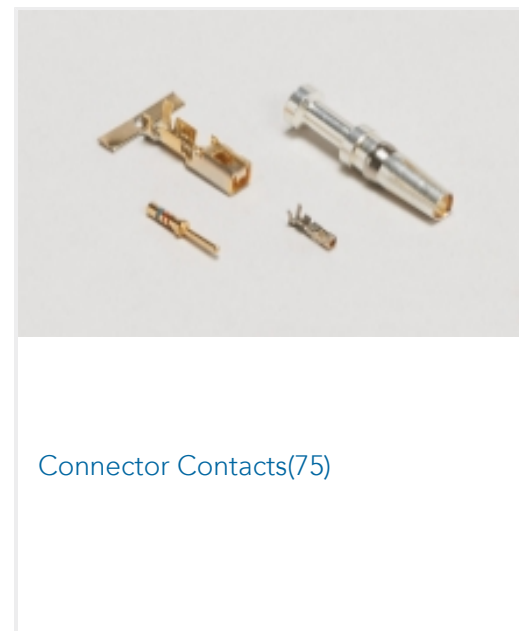
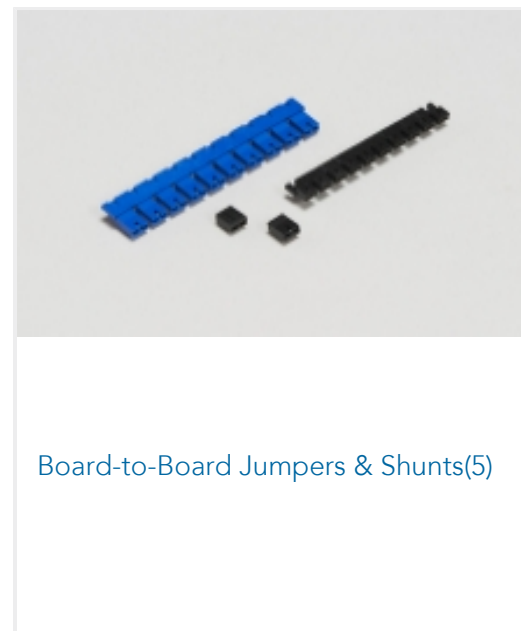
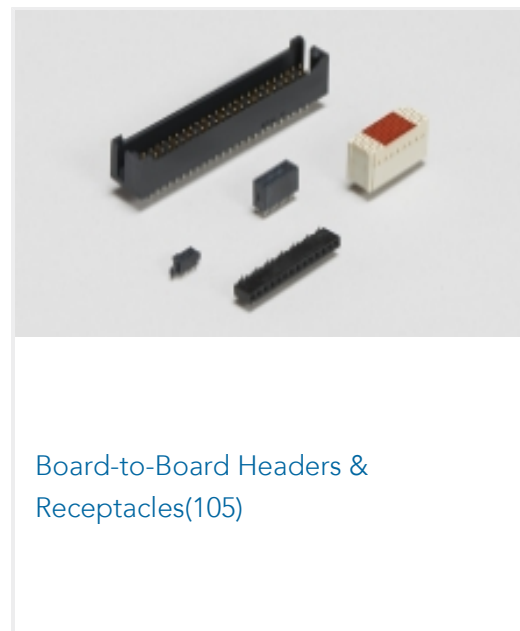
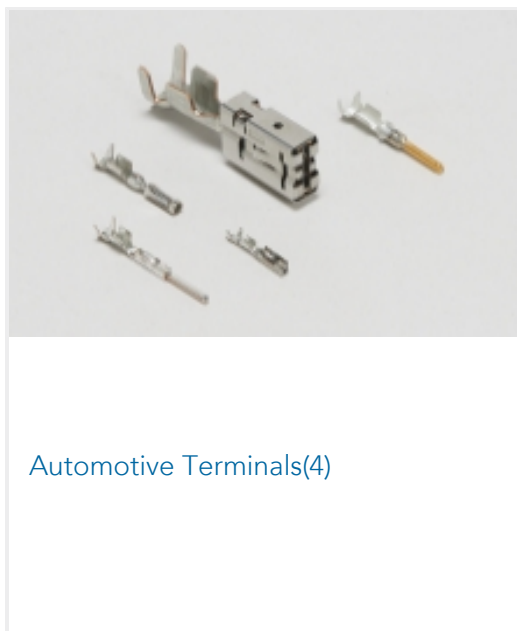

## Customers Also Bought

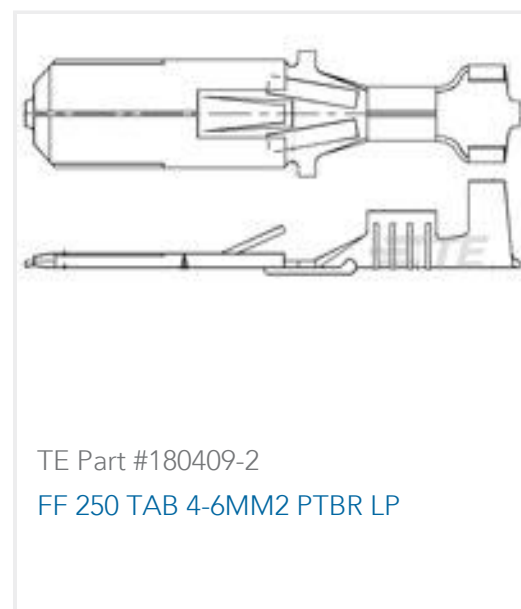
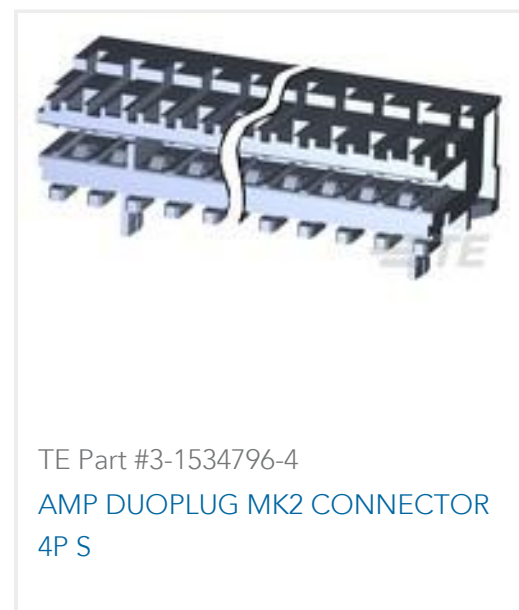
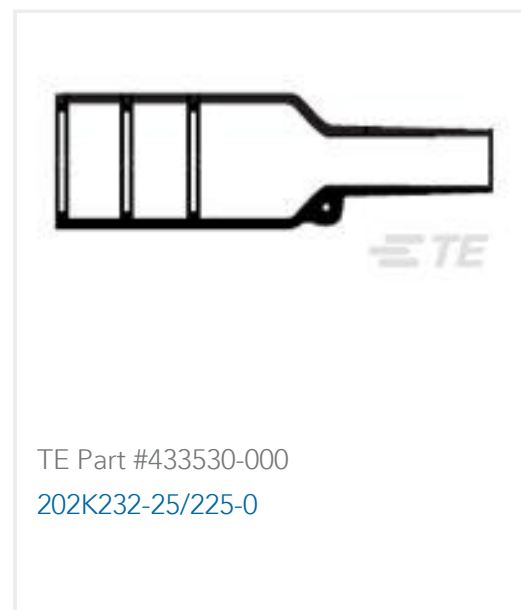
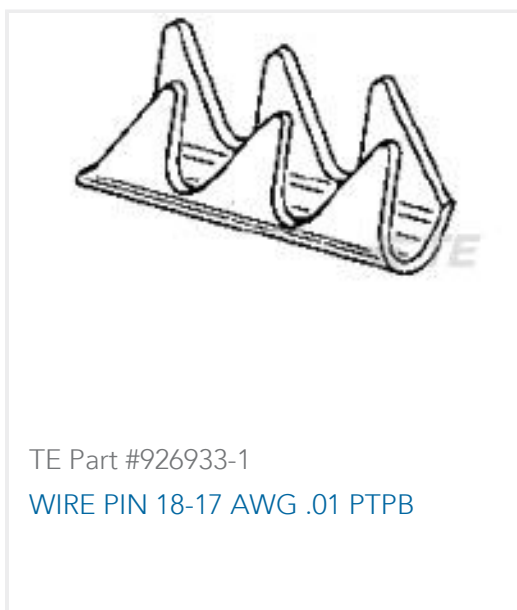

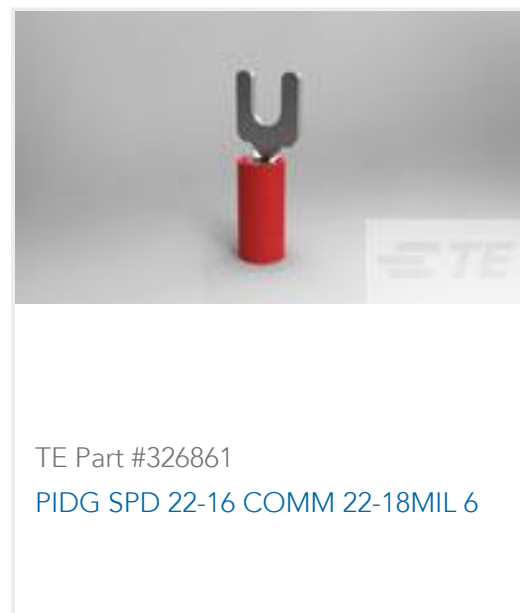

## Documents

### Product Drawings

[MODU I REC.](#)

English

### CAD Files

[3D PDF](#)

3D

Customer View Model

[ENG\\_CVM\\_CVM\\_281423-1\\_H.2d\\_dxf.zip](#)

English

Customer View Model

[ENG\\_CVM\\_CVM\\_281423-1\\_H.3d\\_igs.zip](#)

English

Customer View Model

[ENG\\_CVM\\_CVM\\_281423-1\\_H.3d\\_stp.zip](#)

English

[3D PDF](#)

English

Customer View Model

[ENG\\_CVM\\_281423-1\\_H.3d\\_igs.zip](#)

English

Customer View Model

[ENG\\_CVM\\_281423-1\\_H.3d\\_stp.zip](#)

English

Customer View Model

[ENG\\_CVM\\_281423-1\\_H.2d\\_dxf.zip](#)

English

By downloading the CAD file I accept and agree to the [Terms and Conditions](#) of use.

### Product Specifications

[Application Specification](#)

English