

2291174-1 ✓ ACTIVE

AMP | 0.64/025 Connector System

TE Internal #: 2291174-1

Vertical, Wire-to-Board, 16 Position, 2 Row, 2.2mm [.087in]

Centerline, Tin over Nickel, Printed Circuit Board, Signal, 0.64/025

Connector System

[View on TE.com >](#)



Automotive Parts > Automotive Connectors > Automotive Headers > Press-Fit & SMT Header

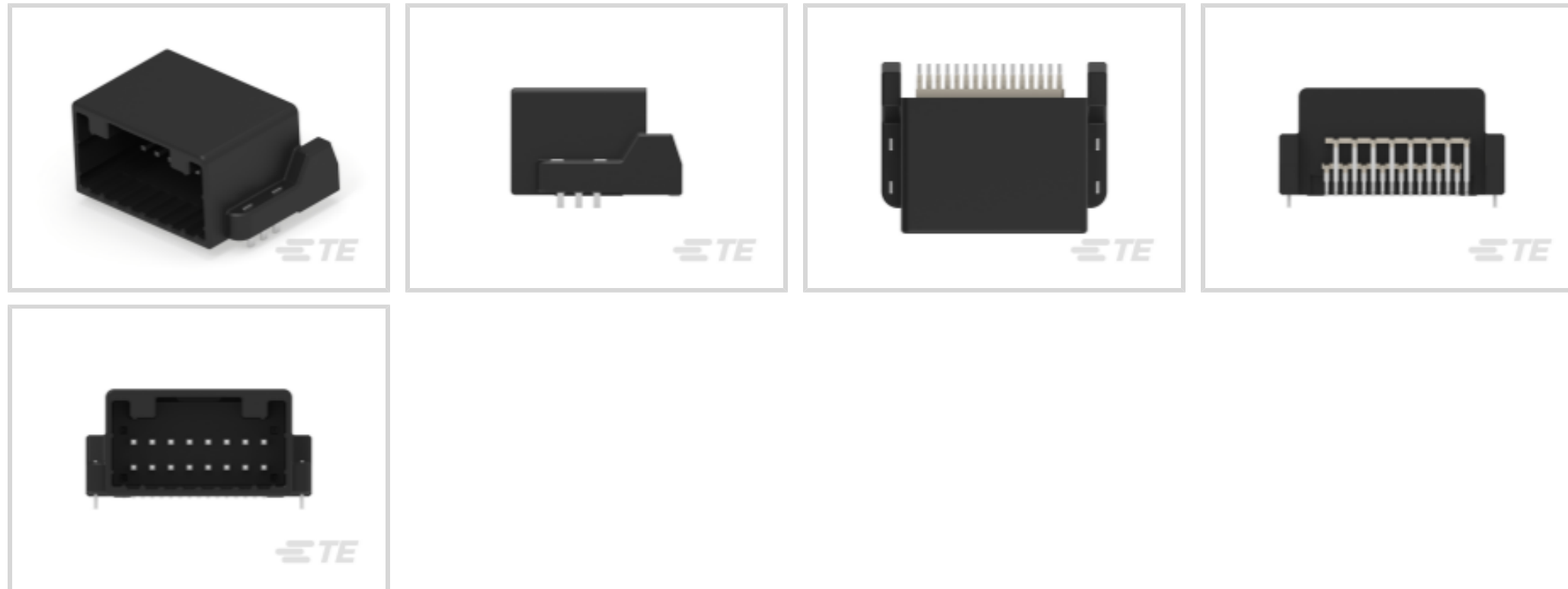

PCB Mount Orientation: **Vertical**

Termination Method to PCB: **Surface Mount**

Sealable: **No**

Centerline (Pitch): **2.2 mm [.087 in]**

Connector System: **Wire-to-Board**

[All Press-Fit & SMT Header \(22\)](#)

Features

Product Type Features

Connector Product Type	Connector Assembly
Mixed & Hybrid Header	No
Header Type	Fully Shrouded
Connector Shape	Rectangular
Sealable	No
Connector System	Wire-to-Board
Connector & Contact Terminates To	Printed Circuit Board

Configuration Features

Number of Signal Positions	16
Number of Sections	1
PCB Mount Orientation	Vertical
Number of Positions	16
Number of Rows	2



Electrical Characteristics

Operating Voltage	12 VDC
Voltage Rating (Max)	12 VDC
Nominal Voltage Architecture	12 V

Body Features

Primary Product Color	Black
-----------------------	-------

Contact Features

Mating Tab Width	.64 mm[.025 in]
Mating Tab Thickness	.64 mm[.025 in]
Contact Type	Tab
Contact Mating Area Plating Material	Tin over Nickel

Termination Features

Termination Method to PCB	Surface Mount
---------------------------	---------------

Mechanical Attachment

Panel Mount Feature	Without
Mating Retention Type	Locking Interface
PCB Mount Retention	With
Mounting Holes	With
Mating Alignment Type	Keyed
PCB Mount Retention Type	Solder Peg, Solder Tail
Mating Alignment	With
PCB Mount Alignment	With
Connector Mounting Type	Board Mount

Housing Features

Centerline (Pitch)	2.2 mm[.087 in]
--------------------	-----------------

Dimensions

	.063 in
Connector Width	26.6 mm[1.05 in]
Profile Height from PCB	12.7 mm[.5 in]
Connector Length	20.2 mm[.79 in]

Usage Conditions

--	--



Operating Temperature (Max)	105 °C[221 °F]
Operating Temperature Range	-40 – 105 °C[-40 – 221 °F]

Operation/Application

Solder Process	Reflow Solder Capable
Shielded	No
Circuit Application	Signal

Industry Standards

UL Flammability Rating	UL 94V-0
------------------------	----------

Packaging Features

Packaging Quantity	170
Packaging Method	Reel

Product Compliance

[For compliance documentation, visit the product page on TE.com>](#)

EU RoHS Directive 2011/65/EU	Compliant
EU ELV Directive 2000/53/EC	Compliant
China RoHS 2 Directive MIIT Order No 32, 2016	有害物质含量符合标准要求 No Restricted Substance(s) Above Threshold
EU REACH Regulation (EC) No. 1907/2006	Current ECHA Candidate List: JUNE 2025 (250) Candidate List Declared Against: JUNE 2025 (250) Does not contain REACH SVHC
Halogen Content	BFR/CFR/PVC Free, but Br/Cl >900 ppm in other sources.
Solder Process Capability	Reflow solder capable to 245°C

Product Compliance Disclaimer

This information is provided based on reasonable inquiry of our suppliers and represents our current actual knowledge based on the information they provided. This information is subject to change. The part numbers that TE has identified as EU RoHS compliant have a maximum concentration of 0.1% by weight in homogenous materials for lead, hexavalent chromium, mercury, PBB, PBDE, DBP, BBP, DEHP, DIBP, and 0.01% for cadmium, or qualify for an exemption to these limits as defined in the Annexes of Directive 2011/65/EU (RoHS2). Finished electrical and electronic equipment products will be CE marked as required by Directive 2011/65/EU. Components may not be CE marked. Additionally, the part numbers that TE has identified as EU ELV compliant have a maximum concentration of 0.1% by weight in homogenous materials for lead, hexavalent chromium, and mercury, and 0.01% for cadmium, or qualify for an exemption to these limits as defined in the Annexes of Directive 2000/53/EC (ELV). Regarding the REACH Regulation, the information TE provides on SVHC in articles for this part number is based on the latest European Chemicals Agency (ECHA) 'Guidance on requirements for substances in articles' posted at this URL: <https://echa.europa.eu/guidance-documents/guidance-on-reach>



Compatible Parts

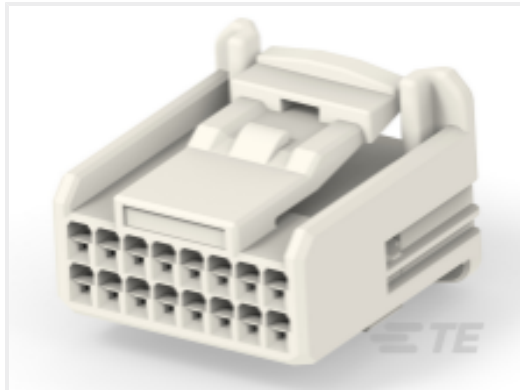

TE Part # 1717109-1
0.64 III 16POS PLUG ASSY

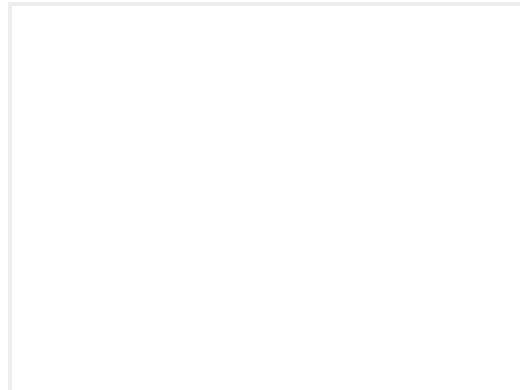

TE Part # 2237061-4
0.64 TAB CONTACT (S)-PLATED

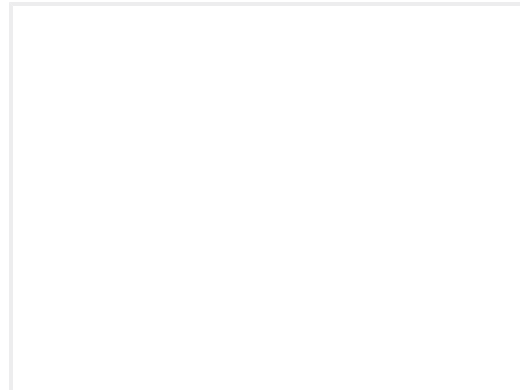

TE Part # 2237061-2
0.64 TAB CONTACT (L)-PLATED

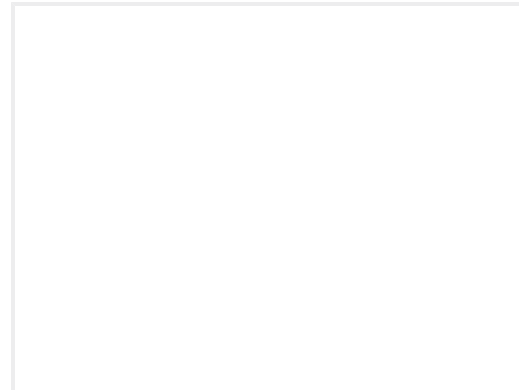

TE Part # 2237062-2
SOLDER FORK - (PLATED)

Also in the Series | 0.64/025 Connector System

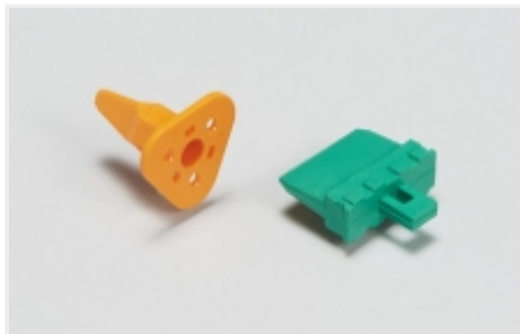

Automotive Connector Locks & Position Assurance(1)

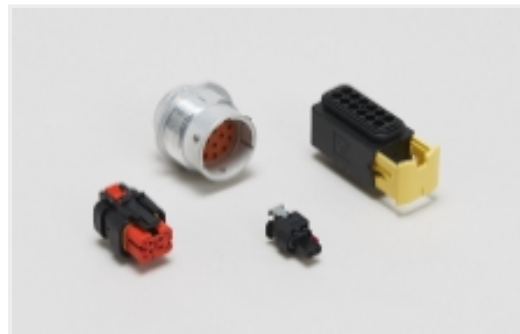

Automotive Housings(173)



Automotive Seals & Cavity Plugs(2)



Automotive Signal & Power Connector Housings(173)

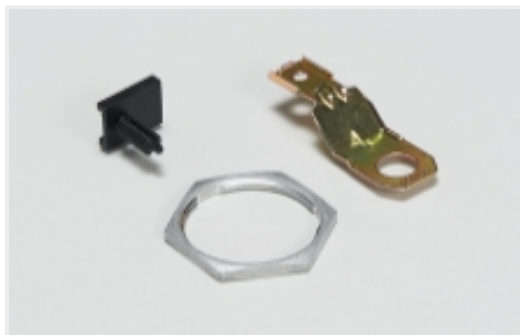

Other Automotive Connector Accessories(4)

Customers Also Bought



TE Part #CAT-SIGH262
Signal Header

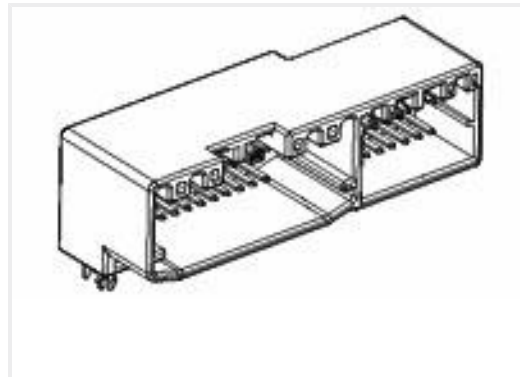

TE Part #9-1438743-6
54way Hyb .040/2.8 Tails Down Cap Assy

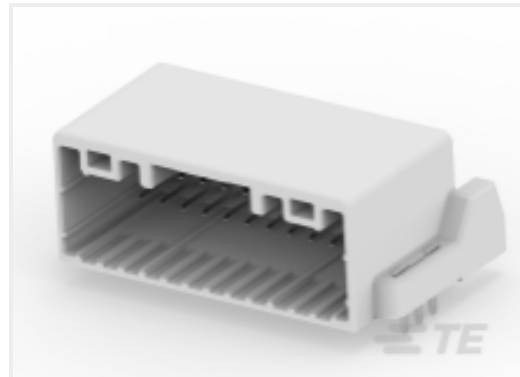

TE Part #2237067-4
24POS,TAB0.64X0.64,HDR ASSY,90 DEG,SMD



TE Part #2315627-5
4POS,0.50,HDR ASSY,180DEG,COD E, HSL

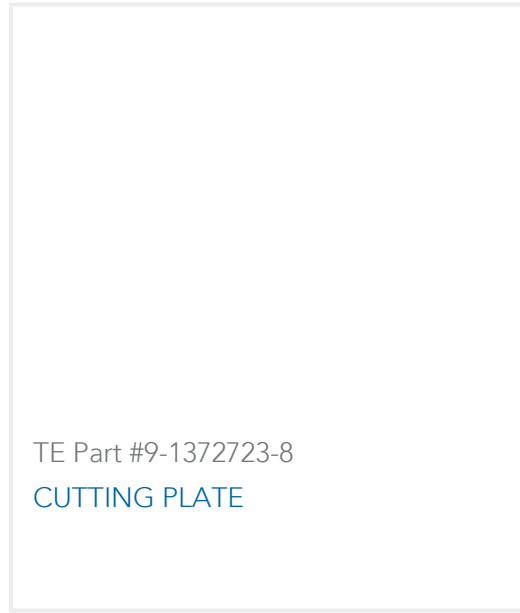
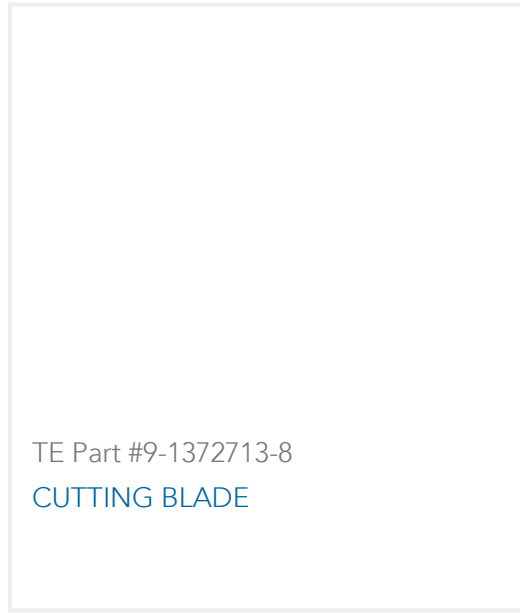

Documents

Product Drawings

025 SMD 16P CAP ASSEMBLY H-TYPE

English

CAD Files

3D PDF

3D

Customer View Model

[ENG_CVM_CVM_2291174-1_A.2d_dxf.zip](#)

English

Customer View Model

[ENG_CVM_CVM_2291174-1_A.3d_igs.zip](#)

English

Customer View Model

[ENG_CVM_CVM_2291174-1_A.3d_stp.zip](#)

English

By downloading the CAD file I accept and agree to the [Terms and Conditions](#) of use.

Product Specifications

Product Specification

English

Instruction Sheets

Instruction Sheet (U.S.)

English