

2141501-1 ✓ ACTIVE

TE Internal #: 2141501-1

TE Internal Description: 3POS,1.5MM SFC,REC HSG,ASSY,SEALED,  
BK

[View on TE.com >](#)



## Product Compliance

[For compliance documentation, visit the product page on TE.com>](#)

EU RoHS Directive 2011/65/EU	Compliant
EU ELV Directive 2000/53/EC	Compliant
China RoHS 2 Directive MIIT Order No 32, 2016	No Restricted Materials Above Threshold
EU REACH Regulation (EC) No. 1907/2006	Current ECHA Candidate List: JUNE 2024 (241) Candidate List Declared Against: JUNE 2022 (224) Does not contain REACH SVHC
Halogen Content	Low Halogen - Br, Cl, F, I < 900 ppm per homogenous material. Also BFR/CFR/PVC Free
Solder Process Capability	Not reviewed for solder process capability

### Product Compliance Disclaimer

This information is provided based on reasonable inquiry of our suppliers and represents our current actual knowledge based on the information they provided. This information is subject to change. The part numbers that TE has identified as EU RoHS compliant have a maximum concentration of 0.1% by weight in homogenous materials for lead, hexavalent chromium, mercury, PBB, PBDE, DBP, BBP, DEHP, DIBP, and 0.01% for cadmium, or qualify for an exemption to these limits as defined in the Annexes of Directive 2011/65/EU (RoHS2). Finished electrical and electronic equipment products will be CE marked as required by Directive 2011/65/EU. Components may not be CE marked. Additionally, the part numbers that TE has identified as EU ELV compliant have a maximum concentration of 0.1% by weight in homogenous materials for lead, hexavalent chromium, and mercury, and 0.01% for cadmium, or qualify for an exemption to these limits as defined in the Annexes of Directive 2000/53/EC (ELV). Regarding the REACH Regulation, the information TE provides on SVHC in articles for this part number is based on the latest European Chemicals Agency (ECHA) 'Guidance on requirements for substances in articles' posted at this URL: <https://echa.europa.eu/guidance-documents/guidance-on-reach>

## Compatible Parts

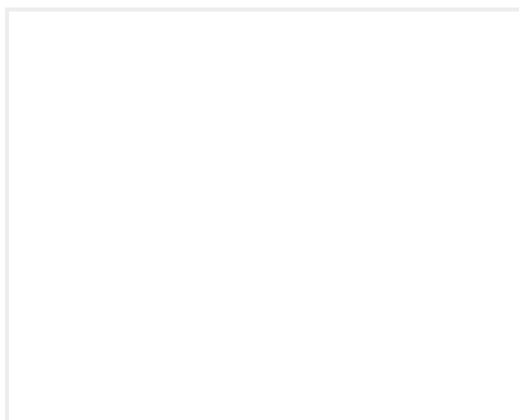

TE Part # 1-1801167-1  
SECOND LOCK DEVICE FOR 3W  
RCPT HSG BLACK

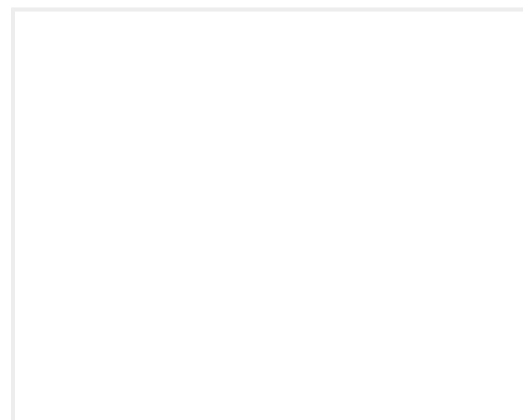

TE Part # 1823179-1  
RADIAL SEAL



TE Part # 1801177-1  
3W TAB CONNECTOR HP BLACK

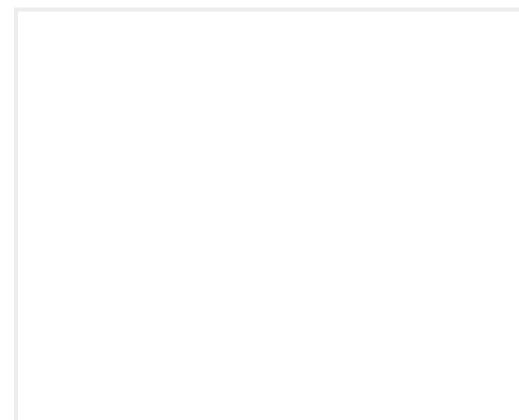

TE Part # 1823178-1  
FAMILY SEAL

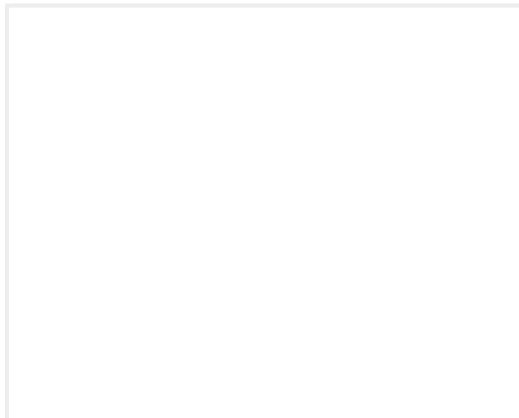

TE Part # 2141233-1  
SLIDE,3WAY



TE Part # CAT-AM706-T273  
AMP MCP, SFC, RECEPTACLE

### Customers Also Bought



TE Part #1452348-1  
5POS HEADER BLOWER SWITCH  
CONN



TE Part #776729-1  
48P Hybrid Cap Assy, A Key, Open



TE Part #936369-1  
090/JPT 25P PLUG ASSY(D.T.B)



TE Part #184000-1  
2 POS. PLUG ASSY, KEY A, BLACK



TE Part #1670144-3  
MCON 1.2 CB REC SRC AG



TE Part #2208732-1  
COVER,OUTGOING 90DEG,ASSY

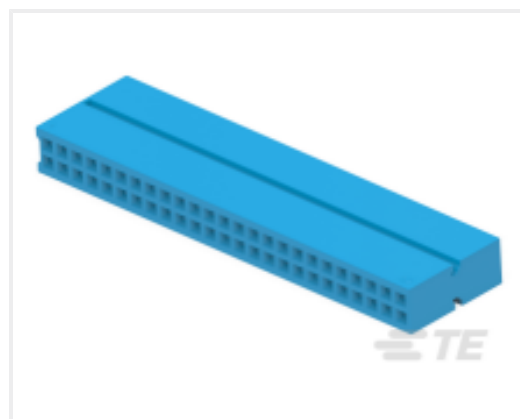

TE Part #2209530-1  
Airbag 50P MQS Rec Hsg

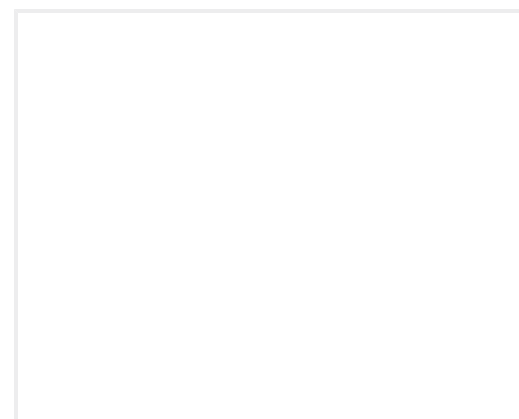

TE Part #1813337-2  
TEH-NO.3-0-50MM



TE Part #1-1801467-1  
COVER, FIXED, 3 WAY HP  
CONNECTOR



TE Part #1437710-5  
106025=CONN. 8W MALE TYPE 'G'

### Documents



### Product Drawings

3POS,1.5MM SFC,REC HSG,ASSY,SEALED,BK

English

---

### CAD Files

3D PDF

3D

Customer View Model

[ENG\\_CVM\\_CVM\\_2141501-1\\_B.2d\\_dxf.zip](#)

English

Customer View Model

[ENG\\_CVM\\_CVM\\_2141501-1\\_B.3d\\_igs.zip](#)

English

Customer View Model

[ENG\\_CVM\\_CVM\\_2141501-1\\_B.3d\\_stp.zip](#)

English

By downloading the CAD file I accept and agree to the [Terms and Conditions](#) of use.

---

### Product Specifications

[Application Specification](#)

English