

213902-2 ✓ ACTIVE

AMP | AMP CPC

TE Internal #: 213902-2

Cable Clamp Kit, Nylon, Black, 17 Shell Size, 17.86 mm [.703 in]

Cable Entry, UL 94V-1, AMP CPC

[View on TE.com >](#)



Connectors > Connector Accessories > Connector Strain Relief



Strain Relief Accessory Type: **Cable Clamp Kit**

Primary Product Material: **Nylon**

Primary Product Color: **Black**

Compatible With Connector Shell Size: **17**

Cable Entry Diameter: **17.86 mm [.703 in]**

Features

Housing Features

Compatible With Connector Shape: Circular

Body Orientation: Straight

Product Type Features

Strain Relief Accessory Type: Cable Clamp Kit

Body Features

Primary Product Material: Nylon

Primary Product Color: Black

Operation/Application

Compatible With Connector Shell Size: 17

Shielded: No

Dimensions

Cable Entry Diameter: 17.86 mm [.703 in]

Mechanical Attachment

Thread Size: 15/16-20



Industry Standards

UL Flammability Rating	UL 94V-1
------------------------	----------

Packaging Features

Packaging Method	Bulk
Packaging Quantity	100

Other

EU RoHS Compliance	Compliant
EU ELV Compliance	Compliant

Product Compliance

[For compliance documentation, visit the product page on TE.com>](#)

EU RoHS Directive 2011/65/EU	Compliant
EU ELV Directive 2000/53/EC	Compliant
China RoHS 2 Directive MIIT Order No 32, 2016	No Restricted Materials Above Threshold
EU REACH Regulation (EC) No. 1907/2006	Current ECHA Candidate List: JUNE 2024 (241) Candidate List Declared Against: JUNE 2024 (241) Does not contain REACH SVHC
Halogen Content	BFR/CFR/PVC Free, but Br/Cl >900 ppm in other sources.
Solder Process Capability	Not applicable for solder process capability

Product Compliance Disclaimer

This information is provided based on reasonable inquiry of our suppliers and represents our current actual knowledge based on the information they provided. This information is subject to change. The part numbers that TE has identified as EU RoHS compliant have a maximum concentration of 0.1% by weight in homogenous materials for lead, hexavalent chromium, mercury, PBB, PBDE, DBP, BBP, DEHP, DIBP, and 0.01% for cadmium, or qualify for an exemption to these limits as defined in the Annexes of Directive 2011/65/EU (RoHS2). Finished electrical and electronic equipment products will be CE marked as required by Directive 2011/65/EU. Components may not be CE marked. Additionally, the part numbers that TE has identified as EU ELV compliant have a maximum concentration of 0.1% by weight in homogenous materials for lead, hexavalent chromium, and mercury, and 0.01% for cadmium, or qualify for an exemption to these limits as defined in the Annexes of Directive 2000/53/EC (ELV). Regarding the REACH Regulation, the information TE provides on SVHC in articles for this part number is based on the latest European Chemicals Agency (ECHA) 'Guidance on requirements for substances in articles' posted at this URL: <https://echa.europa.eu/guidance-documents/guidance-on-reach>

Compatible Parts



Also in the Series | AMP CPC

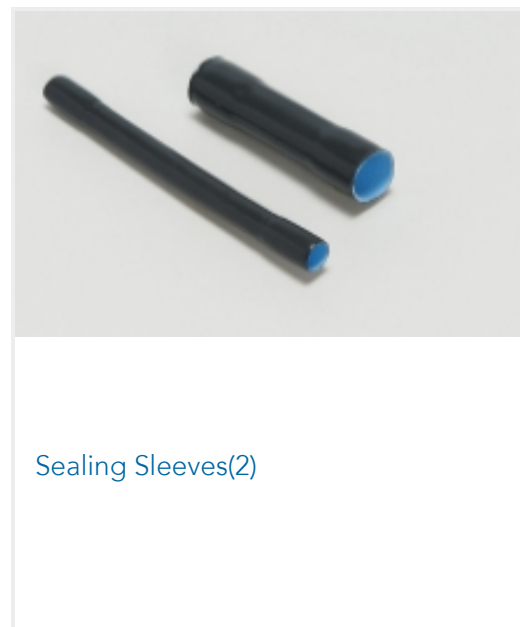
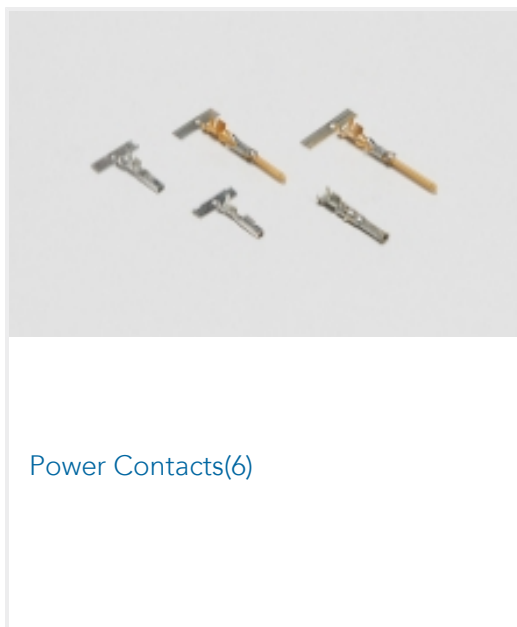
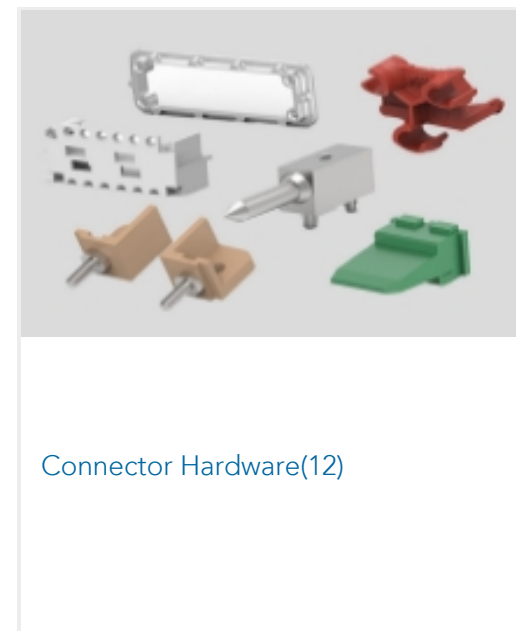
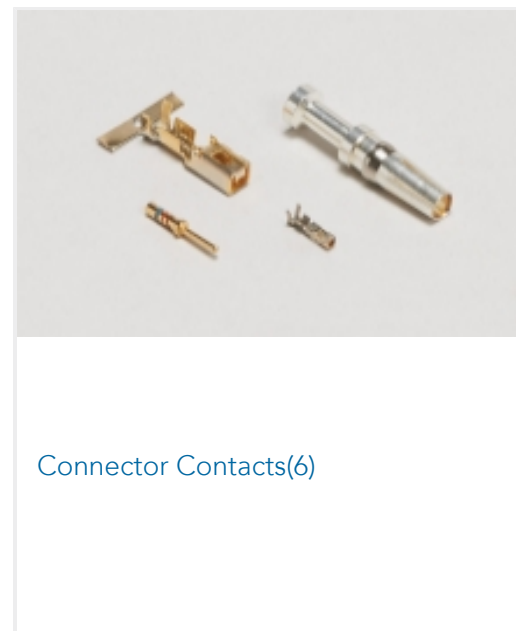
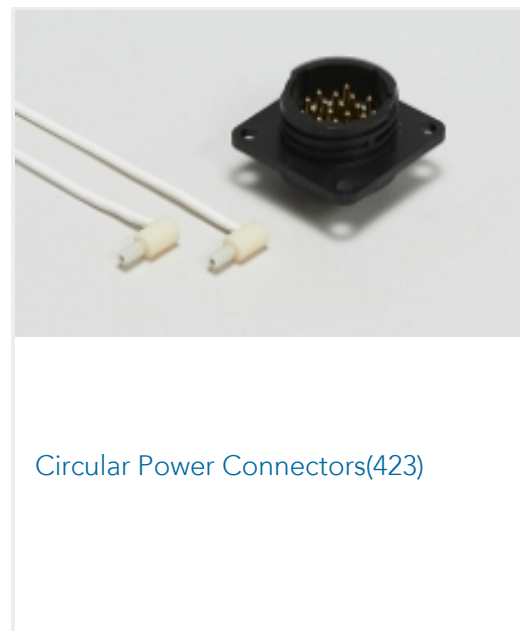
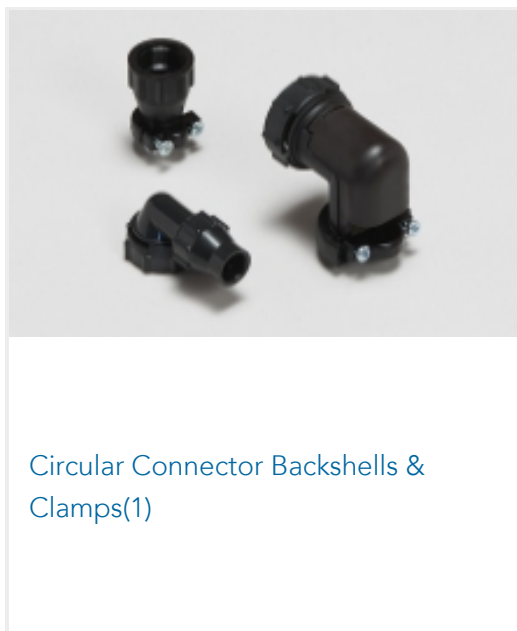

Customers Also Bought

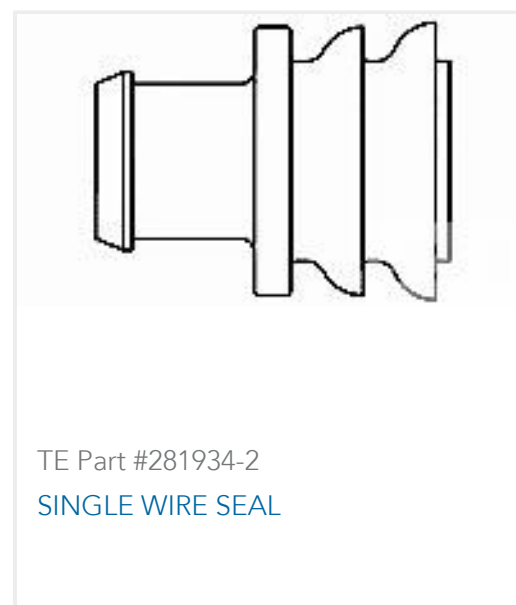



Documents

Product Drawings

[CPC CBL CLMP KIT,LRG,SZ17,BULK](#)

English

CAD Files

Customer View Model

[ENG_CVM_213902-2_B.2d_dxf.zip](#)

English

3D PDF

English

Customer View Model

[ENG_CVM_213902-2_B.3d_igs.zip](#)

English

Customer View Model

[ENG_CVM_213902-2_B.3d_stp.zip](#)

English

By downloading the CAD file I accept and agree to the [Terms and Conditions](#) of use.

Product Specifications

[Product Specification](#)

English

Agency Approvals

[CSA Certificate](#)

English

[CSA Certificate](#)

English