

2098634-1 ✓ ACTIVE

Generation Y Connector System

TE Internal #: 2098634-1

20 Position Housing, Housing for Female Terminals, Wire-to-Board / Wire-to-Device, 2.54 mm [.1 in] Centerline, Black, Generation Y Connector System

[View on TE.com >](#)



Connectors > Automotive Connectors > Automotive Housings

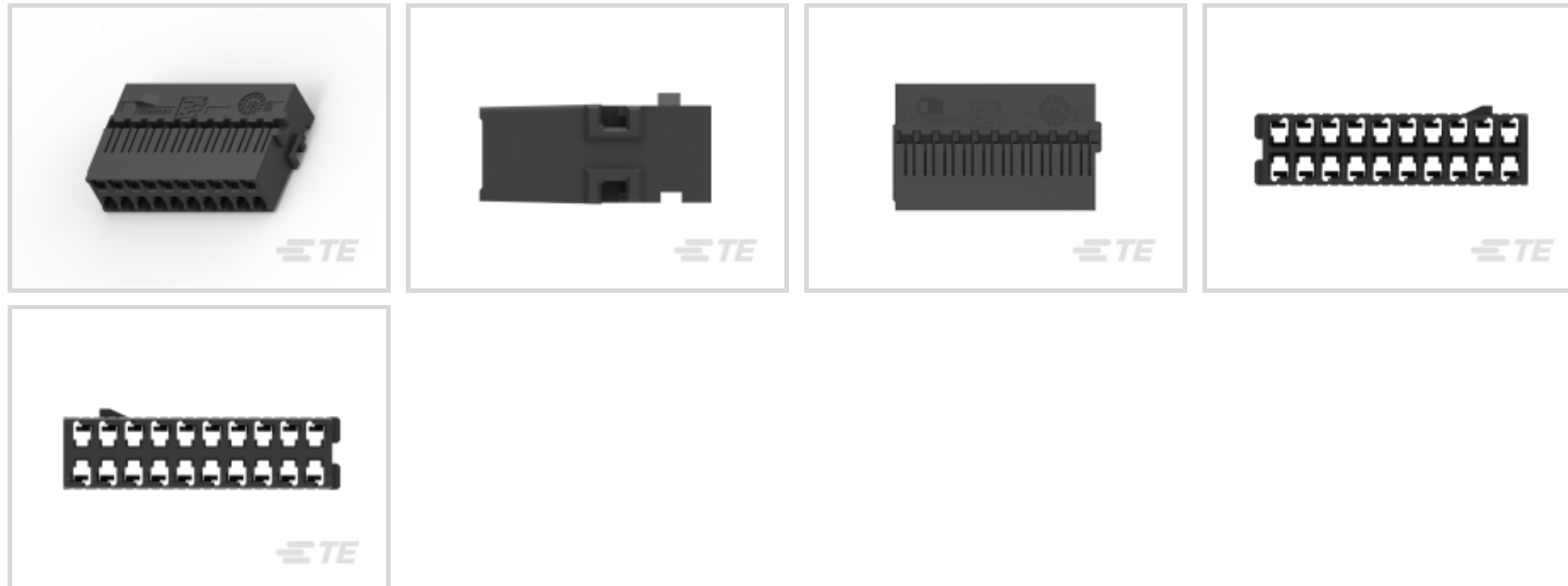

Number of Positions: 20

Connector & Housing Type: **Housing for Female Terminals**

Mating Tab Width: .64 mm [.025 in]

Connector System: **Wire-to-Board, Wire-to-Device**

Centerline (Pitch): 2.54 mm [.1 in]

Features

Dimensions

Row-to-Row Spacing	6 mm[.236 in]
Product Width	7.8 mm[.307 in]
Product Length	27.18 mm[1.07 in]
Connector Height	16.5 mm[.65 in]

Packaging Features

Packaging Method	Package
Packaging Quantity	50

Mechanical Attachment

Strain Relief	Add By Accessory
Terminal Position Assurance	Yes
Mating Alignment Type	Keyed
Mating Alignment	With
Connector Mounting Type	Cable Mount (Free-Hanging)

Other



Serviceable	Yes
Connector Position Assurance Capable	No
EU RoHS Compliance	Compliant
EU ELV Compliance	Compliant

Body Features

Cable Exit Angle	180°
Primary Product Color	Black
Connector & Keying Code	A

Housing Features

Housing Material	PA GF
Centerline (Pitch)	2.54 mm [.1 in]

Contact Features

Contact Size	.64mm
Contact Type	Receptacle
Mating Tab Width	.64 mm [.025 in]

Product Type Features

Mixed & Hybrid Connector	No
Connector Shape	Rectangular
Connector & Housing Type	Housing for Female Terminals
Connector System	Wire-to-Board, Wire-to-Device
Sealable	No
Primary Locking Feature	Integrated in Housing

Configuration Features

Number of Positions	20
Number of Rows	2

Usage Conditions

Operating Temperature (Max)	80 °C, 100 °C, 90 °C, 85 °C, 75 °C, 70 °C [167 °F][158 °F][176 °F][194 °F][185 °F][212 °F]
Operating Temperature Range	-40 – 100 °C [-40 – 212 °F]

Operation/Application

Circuit Application	Signal
---------------------	--------



Product Compliance

[For compliance documentation, visit the product page on TE.com>](#)

EU RoHS Directive 2011/65/EU	Compliant
EU ELV Directive 2000/53/EC	Compliant
China RoHS 2 Directive MIIT Order No 32, 2016	No Restricted Materials Above Threshold
EU REACH Regulation (EC) No. 1907/2006	Current ECHA Candidate List: JUNE 2024 (241) Candidate List Declared Against: JUNE 2024 (241) Does not contain REACH SVHC
Halogen Content	Low Halogen - Br, Cl, F, I < 900 ppm per homogenous material. Also BFR/CFR/PVC Free
Solder Process Capability	Not applicable for solder process capability

Product Compliance Disclaimer

This information is provided based on reasonable inquiry of our suppliers and represents our current actual knowledge based on the information they provided. This information is subject to change. The part numbers that TE has identified as EU RoHS compliant have a maximum concentration of 0.1% by weight in homogenous materials for lead, hexavalent chromium, mercury, PBB, PBDE, DBP, BBP, DEHP, DIBP, and 0.01% for cadmium, or qualify for an exemption to these limits as defined in the Annexes of Directive 2011/65/EU (RoHS2). Finished electrical and electronic equipment products will be CE marked as required by Directive 2011/65/EU. Components may not be CE marked. Additionally, the part numbers that TE has identified as EU ELV compliant have a maximum concentration of 0.1% by weight in homogenous materials for lead, hexavalent chromium, and mercury, and 0.01% for cadmium, or qualify for an exemption to these limits as defined in the Annexes of Directive 2000/53/EC (ELV). Regarding the REACH Regulation, the information TE provides on SVHC in articles for this part number is based on the latest European Chemicals Agency (ECHA) 'Guidance on requirements for substances in articles' posted at this URL: <https://echa.europa.eu/guidance-documents/guidance-on-reach>

Compatible Parts



TE Part # 2098633-1
40P Shield Assy, GY LAC



TE Part # 1924955-7
CONTACT,FEMALE0.64,0.13SQMM, UN



TE Part # 1924955-5
CONTACT,FEMALE0.64,0.13SQMM, UN



TE Part # 1924955-2
CONTACT,FEMALE0.64,18AWG, UNSEALED

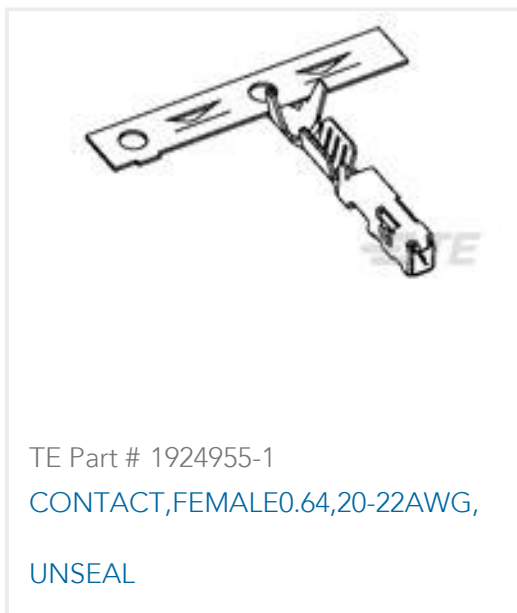

Also in the Series | Generation Y Connector System

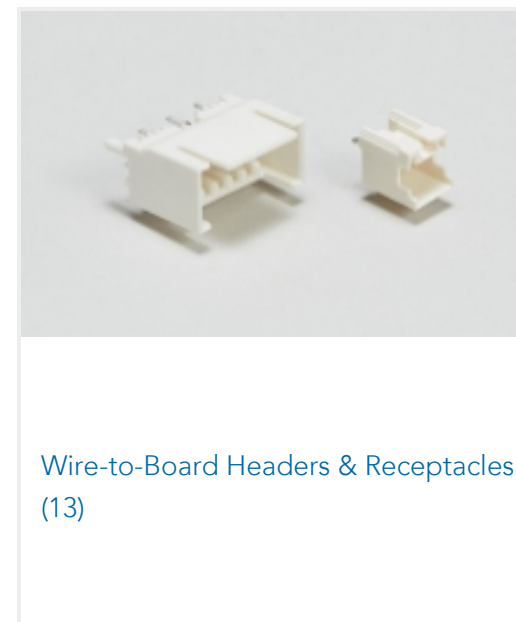
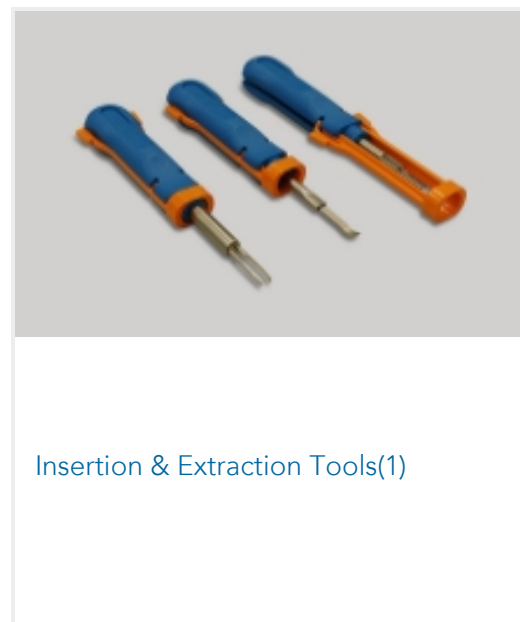
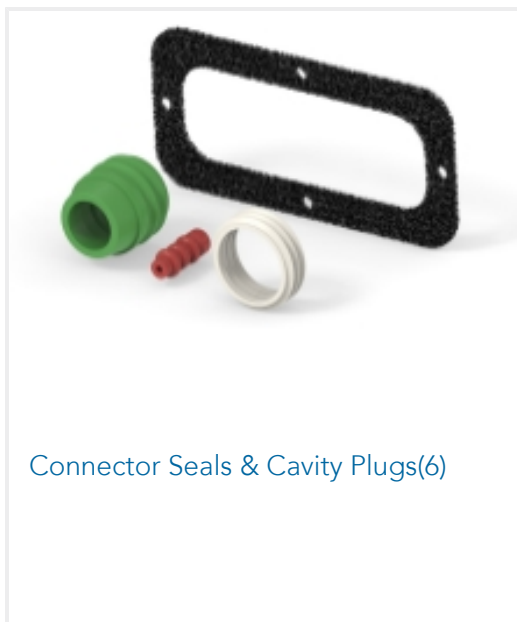
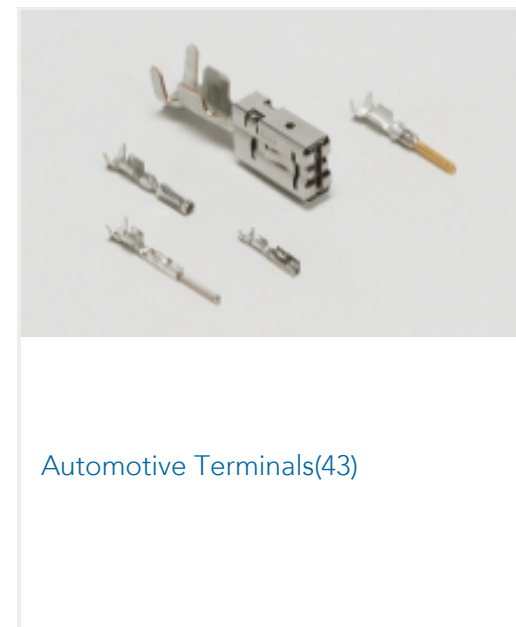
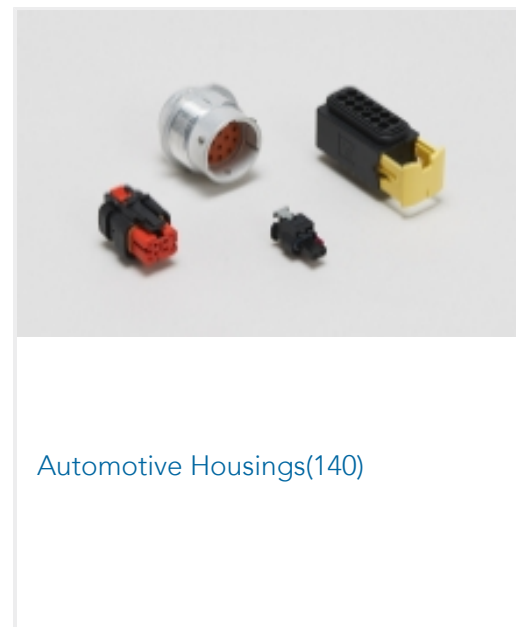
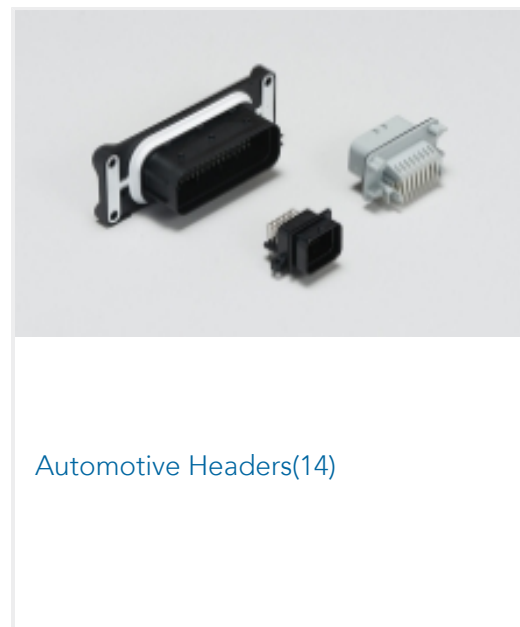

Customers Also Bought





TE Part #2098660-1
32P Shield, GY HandMate



TE Part #1924639-1
1X8 FEMALE ASSY KEY C, LP LATC

Documents

Product Drawings

[Carrier, 20P, GY LAC, Black](#)

English

CAD Files

[3D PDF](#)

3D

Customer View Model

[ENG_CVM_CVM_2098634-1_A.2d_dxf.zip](#)

English

Customer View Model

[ENG_CVM_CVM_2098634-1_A.3d_igs.zip](#)

English

Customer View Model

[ENG_CVM_CVM_2098634-1_A.3d_stp.zip](#)

English

By downloading the CAD file I accept and agree to the [Terms and Conditions](#) of use.

Instruction Sheets

[Instruction Sheet \(U.S.\)](#)

English