

2-936060-1 ✓ ACTIVE

## Sealed Sensor Connector SSC System

TE Internal #: 2-936060-1

3 Position Housing, Wire-to-Board / Wire-to-Device, 5 mm [.197 in]  
Centerline, Sealable, Black, Signal, Sealed Sensor Connector SSC  
System

[View on TE.com >](#)



Connectors > Automotive Connectors > Automotive Housings

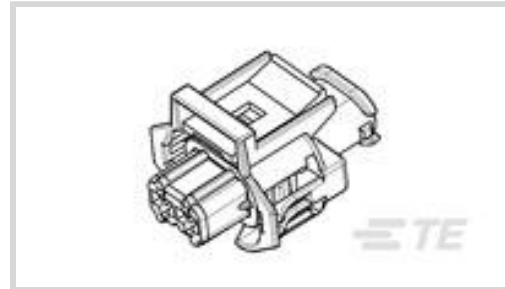

Number of Positions: **3**

Mating Tab Width: **2.8 mm [.11 in]**

Connector System: **Wire-to-Board, Wire-to-Device**

Centerline (Pitch): **5 mm [.197 in]**

Sealable: **Yes**

### Features

#### Dimensions

Product Width	20.1 mm[.791 in]
Product Length	30 mm[1.181 in]
Connector Height	30.5 mm[1.201 in]

#### Packaging Features

Packaging Method	Bag
Packaging Quantity	150

#### Mechanical Attachment

Strain Relief	Without
Terminal Position Assurance	No
Mating Alignment Type	Keyed
Mating Alignment	With
Connector Mounting Type	Cable Mount (Free-Hanging)

#### Other

Serviceable	No
Connector Position Assurance Capable	No
EU RoHS Compliance	Compliant
EU ELV Compliance	Compliant

#### Housing Features



Housing Material	PA GF
Centerline (Pitch)	5 mm [.197 in]

### Product Type Features

Mixed & Hybrid Connector	No
Connector Shape	Rectangular
Connector System	Wire-to-Board, Wire-to-Device
Sealable	Yes

### Contact Features

Contact Size	2.8mm
Mating Tab Width	2.8 mm [.11 in]

### Configuration Features

Number of Positions	3
Number of Rows	1

### Body Features

Primary Product Color	Black
Connector & Keying Code	III

### Operation/Application

Circuit Application	Signal
---------------------	--------

## Product Compliance

[For compliance documentation, visit the product page on TE.com>](#)

EU RoHS Directive 2011/65/EU	Compliant
EU ELV Directive 2000/53/EC	Compliant
China RoHS 2 Directive MIIT Order No 32, 2016	No Restricted Materials Above Threshold
EU REACH Regulation (EC) No. 1907/2006	Current ECHA Candidate List: JUNE 2024 (241) Candidate List Declared Against: JUNE 2024 (241) Does not contain REACH SVHC
Halogen Content	Low Halogen - Br, Cl, F, I < 900 ppm per homogenous material. Also BFR/CFR/PVC Free
Solder Process Capability	Not applicable for solder process capability

Product Compliance Disclaimer



This information is provided based on reasonable inquiry of our suppliers and represents our current actual knowledge based on the information they provided. This information is subject to change. The part numbers that TE has identified as EU RoHS compliant have a maximum concentration of 0.1% by weight in homogenous materials for lead, hexavalent chromium, mercury, PBB, PBDE, DBP, BBP, DEHP, DIBP, and 0.01% for cadmium, or qualify for an exemption to these limits as defined in the Annexes of Directive 2011/65/EU (RoHS2). Finished electrical and electronic equipment products will be CE marked as required by Directive 2011/65/EU. Components may not be CE marked. Additionally, the part numbers that TE has identified as EU ELV compliant have a maximum concentration of 0.1% by weight in homogenous materials for lead, hexavalent chromium, and mercury, and 0.01% for cadmium, or qualify for an exemption to these limits as defined in the Annexes of Directive 2000/53/EC (ELV). Regarding the REACH Regulation, the information TE provides on SVHC in articles for this part number is based on the latest European Chemicals Agency (ECHA) 'Guidance on requirements for substances in articles' posted at this URL: <https://echa.europa.eu/guidance-documents/guidance-on-reach>

## Compatible Parts



TE Part # 2297696-2  
2.8MM SLD 3P PLUG COVER HSG



TE Part # 936106-1  
2.8MM SLD 3P PLUG RETAINER YEL



TE Part # 828904-1  
SINGLE WIRE SEAL FOR J.P.T.CON



TE Part # 828905-1  
SINGLE-WIRE-SEAL(5MM HOLE)



TE Part # 936112-1  
2.8mm Sealed 3P Cover



TE Part # CAT-AM706-T273  
AMP MCP, SFC, RECEPTACLE



TE Part # 936106-2  
2.8MM SLD 3P PLUG RETAINER BLK



TE Part # 936106-3  
2.8MM SLD 3P PLUG RETAINER GRY

## Also in the Series | Sealed Sensor Connector SSC System



Automotive Connector Caps & Covers  
(2)

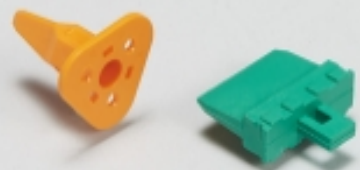

Automotive Connector Locks & Position Assurance(2)



Automotive Housings(34)



Automotive Terminals(5)

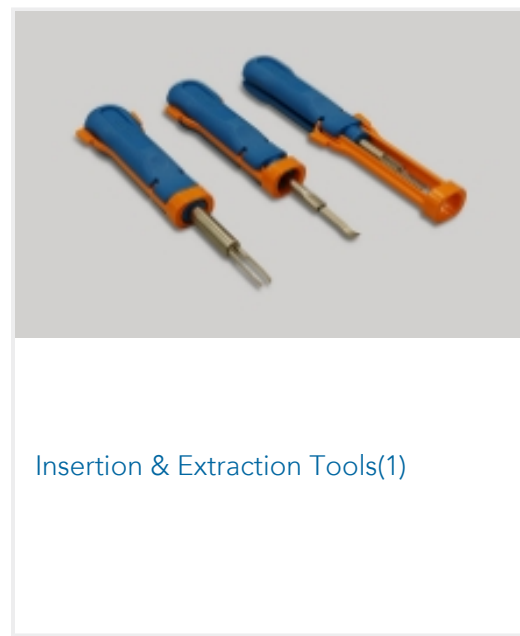
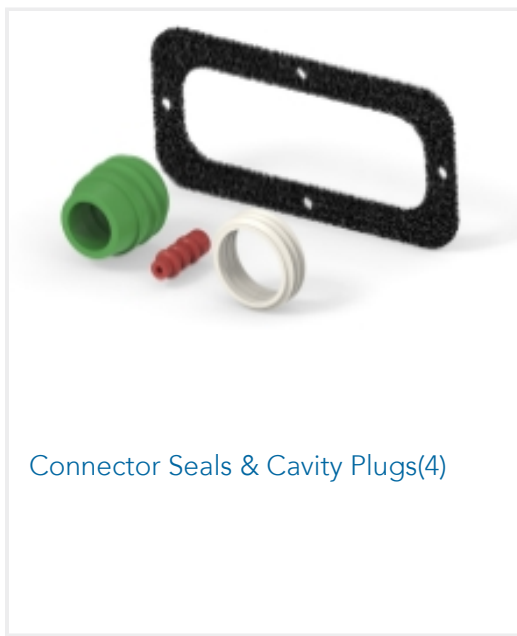

## Customers Also Bought

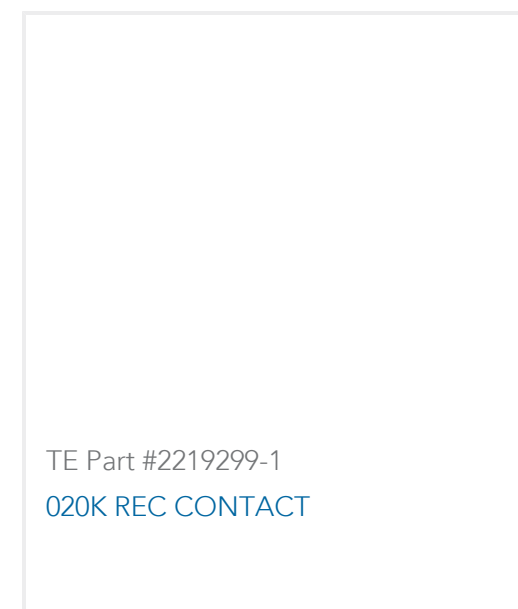
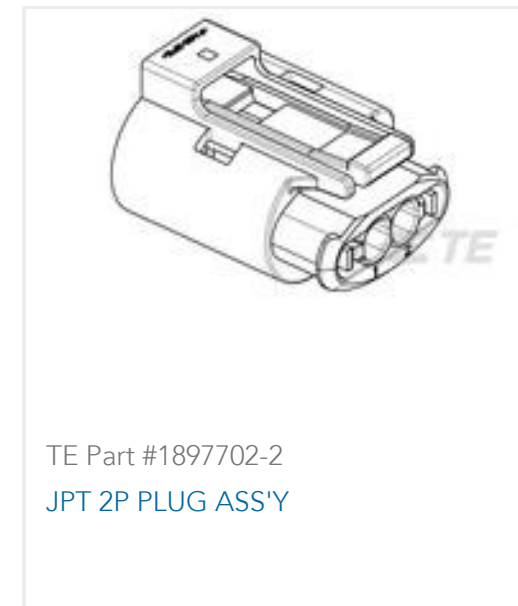

## Documents

### Product Drawings

[2.8MM SLD 3P PLUG ASSY](#)

English

### CAD Files

Customer View Model

[ENG\\_CVM\\_CVM\\_2-936060-1\\_C.2d\\_dxf.zip](#)

English

[3D PDF](#)



3D

Customer View Model

[ENG\\_CVM\\_CVM\\_2-936060-1\\_C.3d\\_igs.zip](#)

English

Customer View Model

[ENG\\_CVM\\_CVM\\_2-936060-1\\_C.3d\\_stp.zip](#)

English

By downloading the CAD file I accept and agree to the [Terms and Conditions](#) of use.

## Product Specifications

[Application Specification](#)

English

[2.8MM SENSOR FLAT TYPE RECEPTACLE CONTACT SYSTEM](#)

English

[Application Specification](#)

English