



PIDG

TE Internal #: 2-36153-3

Closed Ring Tongue Terminal, 22 AWG, #10 Stud, 5 mm [.197 in] Stud Diameter, Closed Barrel, Straight, Tin Plating, Partially Insulated, PIDG

[View on TE.com >](#)

Terminals & Splices > Ring Terminals > PIDG Ring Tongue Terminals

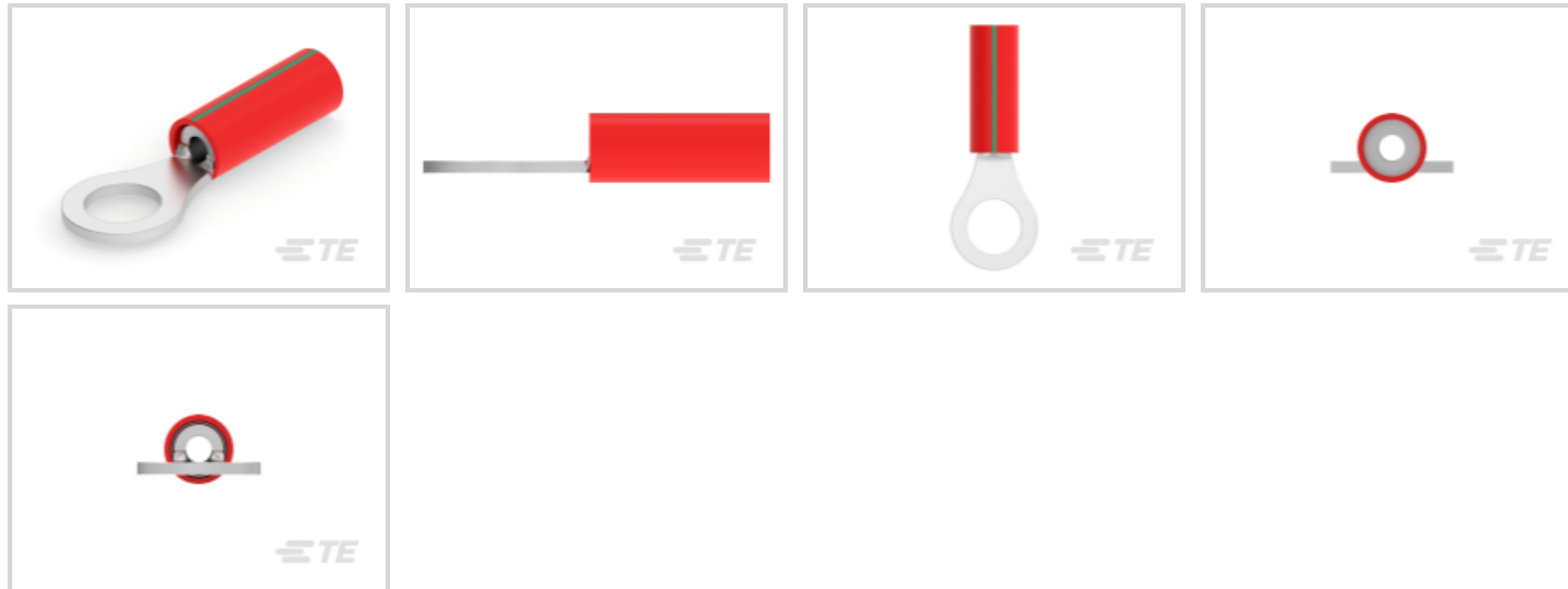

Ring Terminal Product Type: Closed Ring Tongue Terminal

Wire Size: 754 CMA

Stud Size: #10

Stud Diameter: 5 mm [.197 in]

[All PIDG Ring Tongue Terminals \(410\)](#)

Features

Configuration Features

Number of Holes	1
-----------------	---

Mechanical Attachment

Wire Insulation Support	With
-------------------------	------

Electrical Characteristics

Voltage Rating	300 V
----------------	-------

Industry Standards

Government Qualified Terminal	Yes
-------------------------------	-----

Body Features

Product Weight	.83 g
Stripe Color	Green

Packaging Features

Packaging Quantity	1000
--------------------	------

Packaging Method	Loose Piece
------------------	-------------

### Contact Features

Military Part Class	Class I
Barrel Type	Closed
Terminal Orientation	Straight
Terminal Plating Material	Tin

### Product Type Features

Ring Terminal Product Type	Closed Ring Tongue Terminal
Stud Size	#10
Sealable	No
Wire Insulation Support Retention Type	Insulation Restriction

### Dimensions

Wire Size	754 CMA
Stud Diameter	5 mm [.197 in]
Tongue Thickness	.79 mm [.031 in]
Product Length	23.01 mm [.91 in]
Compatible Insulation Diameter (Max)	2.79 mm [.11 in]
Compatible Insulation Diameter Range	.97 – 2.79 mm [.038 – .11 in]

### Usage Conditions

Insulation Option	Partially Insulated
-------------------	---------------------

### Operation/Application

Compatible With Wire Base Material	Copper
Compatible With Wire Plating Material	Tin

### Other

EU RoHS Compliance	Compliant
EU ELV Compliance	Compliant

### Product Compliance

[For compliance documentation, visit the product page on TE.com>](#)

EU RoHS Directive 2011/65/EU	Compliant
EU ELV Directive 2000/53/EC	Compliant
China RoHS 2 Directive MIIT Order No 32, 2016	No Restricted Materials Above Threshold

EU REACH Regulation (EC) No. 1907/2006

Current ECHA Candidate List: JUNE 2024 (241)

Candidate List Declared Against: JUNE 2024 (241)

Does not contain REACH SVHC

Halogen Content

Low Halogen - Br, Cl, F, I < 900 ppm per homogenous material. Also BFR/CFR/PVC Free

Solder Process Capability

Not applicable for solder process capability

Product Compliance Disclaimer

This information is provided based on reasonable inquiry of our suppliers and represents our current actual knowledge based on the information they provided. This information is subject to change. The part numbers that TE has identified as EU RoHS compliant have a maximum concentration of 0.1% by weight in homogenous materials for lead, hexavalent chromium, mercury, PBB, PBDE, DBP, BBP, DEHP, DIBP, and 0.01% for cadmium, or qualify for an exemption to these limits as defined in the Annexes of Directive 2011/65/EU (RoHS2). Finished electrical and electronic equipment products will be CE marked as required by Directive 2011/65/EU. Components may not be CE marked. Additionally, the part numbers that TE has identified as EU ELV compliant have a maximum concentration of 0.1% by weight in homogenous materials for lead, hexavalent chromium, and mercury, and 0.01% for cadmium, or qualify for an exemption to these limits as defined in the Annexes of Directive 2000/53/EC (ELV). Regarding the REACH Regulation, the information TE provides on SVHC in articles for this part number is based on the latest European Chemicals Agency (ECHA) 'Guidance on requirements for substances in articles' posted at this URL: <https://echa.europa.eu/guidance-documents/guidance-on-reach>

## Compatible Parts



TE Part # 47806-2  
DIES PIDG 22-16 DIE SET



TE Part # 47386  
DAHT PG PIDG 26-16 ASSY



TE Part # 58423-1  
DIE, RBY IS9252



TE Part # 58433-3  
PRO CR ASSY, RBY IS9252



TE Part # 59170  
T-HEAD PIDG SH 26-14 ASSY



TE Part # 169404  
CERTI-LOK DIE



TE Part # 2063030-1  
SDE DIESET, RBY, UL



TE Part # 59300  
T-HEAD PIDG PG 26-16 ASSY



### Also in the Series | PIDG

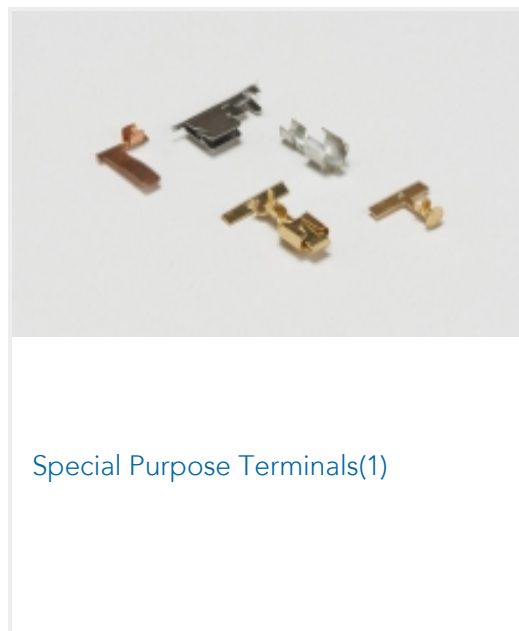
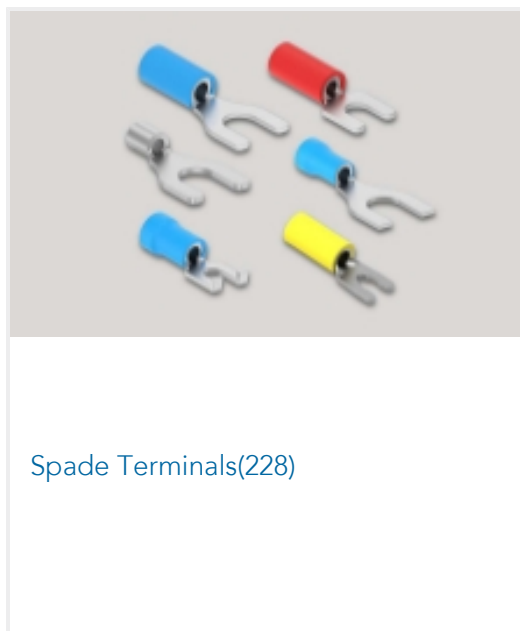
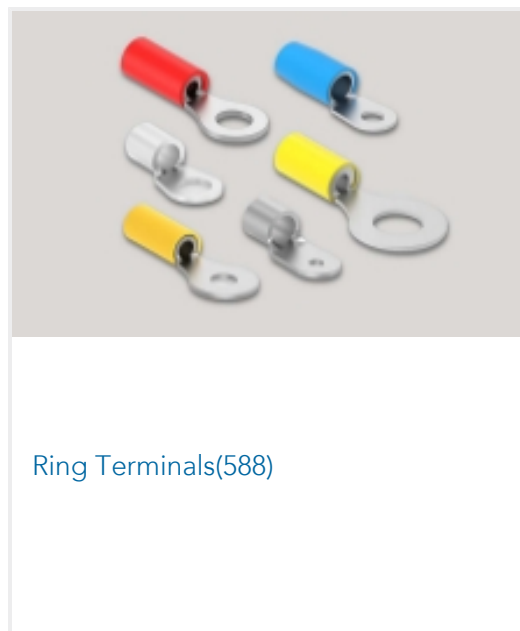
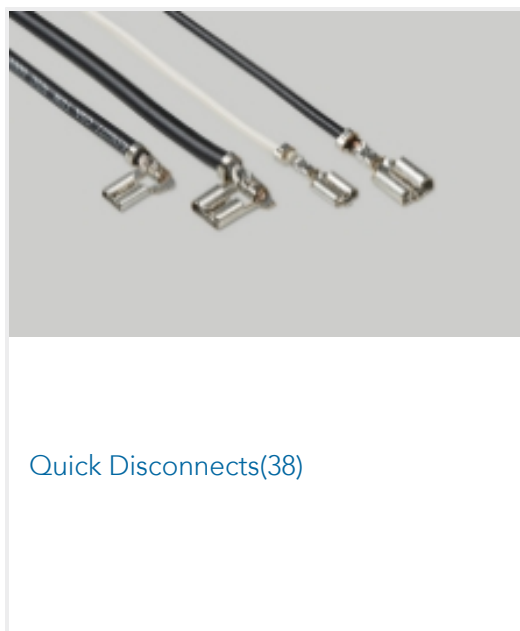
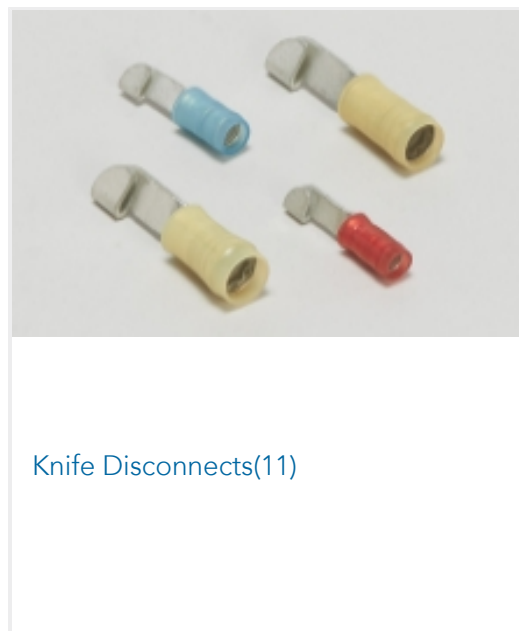
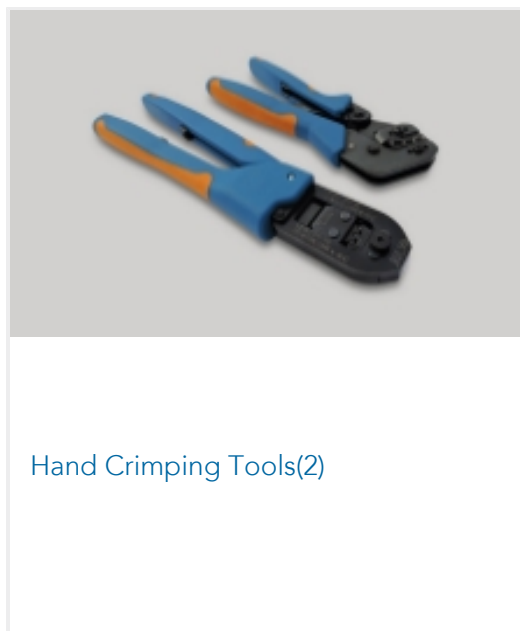
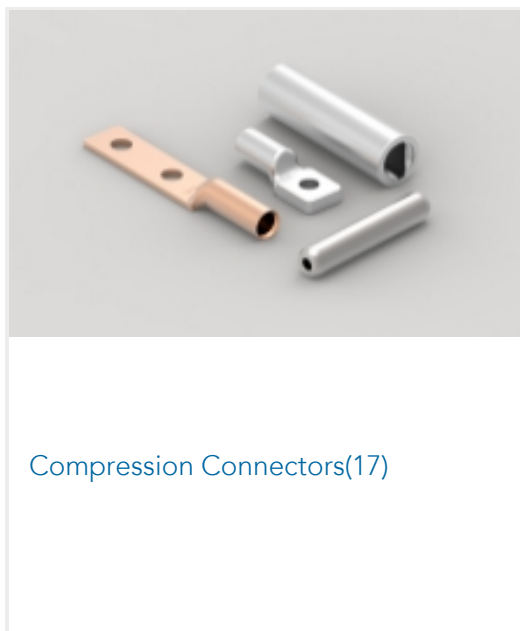

### Customers Also Bought

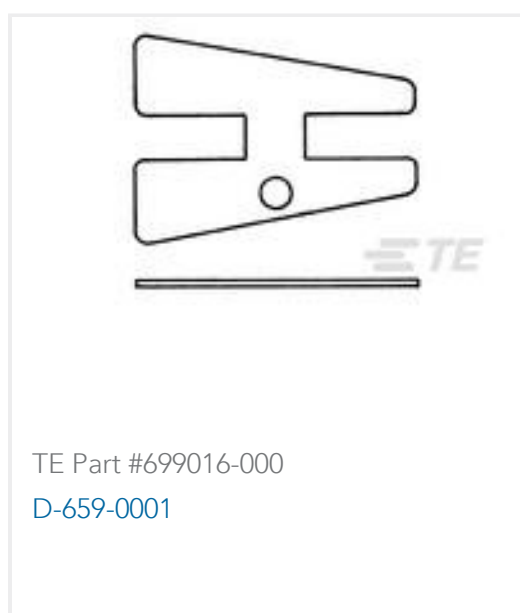



## Documents

### Product Drawings

[TERMINAL,PIDG R IR 22 10](#)

English

---

### CAD Files

[3D PDF](#)

3D

Customer View Model

[ENG\\_CVM\\_CVM\\_2-36153-3\\_AF.2d\\_dxf.zip](#)

English

Customer View Model

[ENG\\_CVM\\_CVM\\_2-36153-3\\_AF.3d\\_igs.zip](#)

English

Customer View Model

[ENG\\_CVM\\_CVM\\_2-36153-3\\_AF.3d\\_stp.zip](#)

English

By downloading the CAD file I accept and agree to the [Terms and Conditions](#) of use.

---

### Agency Approvals

[CSA Certificate](#)

English