

Product Compliance

[For compliance documentation, visit the product page on TE.com>](#)

EU RoHS Directive 2011/65/EU	Compliant
EU ELV Directive 2000/53/EC	Compliant
China RoHS 2 Directive MIIT Order No 32, 2016	No Restricted Materials Above Threshold
EU REACH Regulation (EC) No. 1907/2006	Current ECHA Candidate List: JUNE 2024 (241) Candidate List Declared Against: JUNE 2023 (235) Does not contain REACH SVHC
Halogen Content	Not Low Halogen - contains Br or Cl > 900 ppm.
Solder Process Capability	Reflow solder capable to 260°C

Product Compliance Disclaimer

This information is provided based on reasonable inquiry of our suppliers and represents our current actual knowledge based on the information they provided. This information is subject to change. The part numbers that TE has identified as EU RoHS compliant have a maximum concentration of 0.1% by weight in homogenous materials for lead, hexavalent chromium, mercury, PBB, PBDE, DBP, BBP, DEHP, DIBP, and 0.01% for cadmium, or qualify for an exemption to these limits as defined in the Annexes of Directive 2011/65/EU (RoHS2). Finished electrical and electronic equipment products will be CE marked as required by Directive 2011/65/EU. Components may not be CE marked. Additionally, the part numbers that TE has identified as EU ELV compliant have a maximum concentration of 0.1% by weight in homogenous materials for lead, hexavalent chromium, and mercury, and 0.01% for cadmium, or qualify for an exemption to these limits as defined in the Annexes of Directive 2000/53/EC (ELV). Regarding the REACH Regulation, the information TE provides on SVHC in articles for this part number is based on the latest European Chemicals Agency (ECHA) 'Guidance on requirements for substances in articles' posted at this URL: <https://echa.europa.eu/guidance-documents/guidance-on-reach>

Compatible Parts



TE Part # 2-2307764-5
25P,2MM,B-B,REC,SRVT,2.0,SN,TR,W /CP



TE Part # 2-2307812-5
25P,2MM,BB,REC,SRVT,SMD,SN,TR,W /CP



TE Part # 2-2314867-5
25P,2MM,BB,REC,SRVT,2.0,SN,TUBE W/CAP



TE Part # 2-2307765-5
25P,2MM,B-B,REC,SRVT,2.7,SN,TR,W /CP



TE Part # 2-2314875-5
25P,2MM,BB,REC,SRVT,2.7,SN,TB

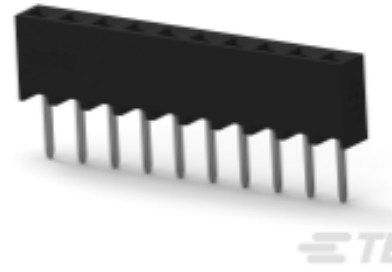

TE Part # 2-2307766-5
25P,2MM,B-B,REC,SRVT,3.2,SN,TUBE



TE Part # 2-2314847-5
25P,2MM,BB,REC,SRVT,SMD,SN,TB W /CP



TE Part # 2-2316102-5
25P,2MM,REC,HSG,SR,CRIMP,PLAIN, BOX



TE Part # 2-2314879-5
25P,2MM,B-B,REC,SRVT,2.7,SN,TB,W /CP

Also in the Series | AMPMODU 2 mm

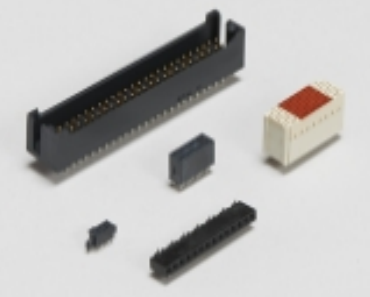

Board-to-Board Headers & Receptacles(8161)



Connector Contacts(27)



PCB Headers & Receptacles(8190)



Wire-to-Board Connector Assemblies & Housings(202)



Wire-to-Board Headers & Receptacles (1037)

Customers Also Bought



TE Part #1-928836-2
MOD2 PIN WITH A-PIN L/P



TE Part #5-103911-3
60 SYSTEM 50 RCPT ASSY DRRA



TE Part #5-104076-2
60 SYS50 HDR DRST SHRD W/SL SN

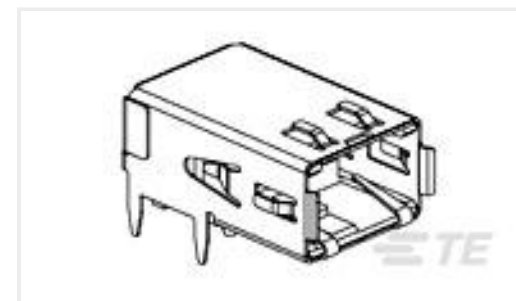

TE Part #1761072-3
RECPT,HSSDC2,FIBRE,TRAY PKG

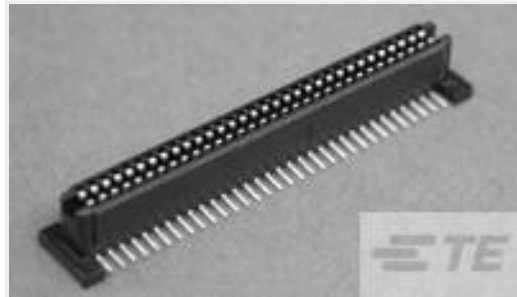

TE Part #5146893-2
1FHR,84,30A/S,S,C,S08,09,10

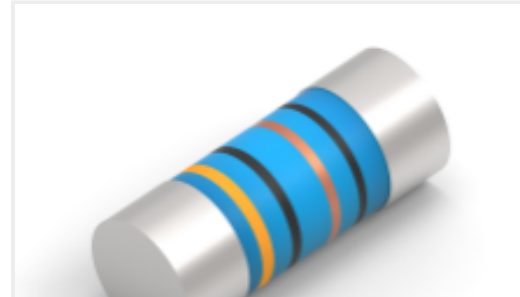

TE Part #2176314-4
MELF SMA_A 180R 0.1% 15PPM 0102
0.3W



TE Part #3-1415020-1
PT570N20

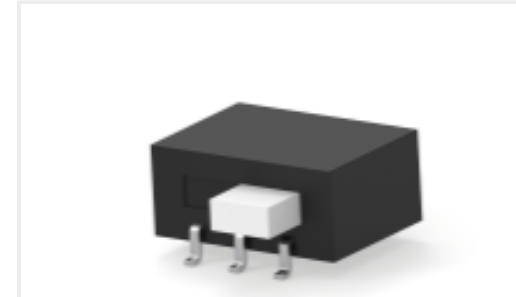

TE Part #1-1437581-1
ASE22RL=AUTOSLIDE DP



TE Part #7-2176246-6
CRGS2512 5% 1M8



TE Part #4-2176391-7
RQ 1206 37K4 0.1% 10PPM 5K RL

Documents

Product Drawings

25P,2MM,BRK HDR,SRRT,2.8,SN,BOX

English

CAD Files

3D PDF

3D

Customer View Model

[ENG_CVM_CVM_2-2842121-5_A.2d_dxf.zip](#)

English

Customer View Model

[ENG_CVM_CVM_2-2842121-5_A.3d_igs.zip](#)

English

Customer View Model

[ENG_CVM_CVM_2-2842121-5_A.3d_stp.zip](#)

English

By downloading the CAD file I accept and agree to the [Terms and Conditions](#) of use.

Product Specifications



Application Specification

English