

2-179228-7 ✓ ACTIVE

AMP CT

TE Internal #: 2-179228-7

Housing, Receptacle, Wire-to-Board / Wire-to-Wire, 7 Position, 2 mm [.079 in] Centerline, Crimp, 1 Row, Blue, Wire & Cable, Power & Signal, AMP CT

[View on TE.com >](#)



[Connectors >](#) [PCB Connectors >](#) [Wire-to-Board Connectors >](#) [Wire-to-Board Connector Assemblies & Housings >](#)

AMP COMMON TERMINATION HOUSINGS



Connector Product Type: **Housing**

Connector & Housing Type: **Receptacle**

Connector System: **Wire-to-Board, Wire-to-Wire**

Number of Positions: **7**

Centerline (Pitch): **2 mm [.079 in]**

[All AMP COMMON TERMINATION HOUSINGS \(176\)](#)

Features

Electrical Characteristics

Operating Voltage	125 VDC
Insulation Resistance	1000 MΩ
Dielectric Withstanding Voltage (Max)	2000 VAC

Industry Standards

Compatible With Agency/Standards Products	UL, CSA
UL Flammability Rating	UL 94V-0
Glow Wire Rating	Standard Part - Not Glow Wire

Packaging Features

Packaging Method	Bag & Box
Packaging Quantity	2500

Dimensions

Connector Width	4.6 mm[.181 in]
Connector Height	6.6 mm[.26 in]
Connector Length	16 mm[.63 in]
Wire Size	30 – 22 AWG

Contact Features



Contact Layout	Inline
Contact Type	Socket
Contact Current Rating (Max)	4 A

Mechanical Attachment

Strain Relief	Without
Panel Mount Feature	Without
PCB Mount Retention	Without
Mating Retention	Without
Connector Mounting Type	Cable Mount (Free-Hanging)

Housing Features

Housing Material	Thermoplastic
Centerline (Pitch)	2 mm [.079 in]

Product Type Features

Connector Product Type	Housing
Connector & Housing Type	Receptacle
Connector System	Wire-to-Board, Wire-to-Wire
Sealable	No
Connector & Contact Terminates To	Wire & Cable

Configuration Features

Number of Positions	7
Number of Rows	1

Body Features

Primary Product Color	Blue
-----------------------	------

Termination Features

Termination Method to Wire & Cable	Crimp
------------------------------------	-------

Usage Conditions

Operating Temperature Range	-30 – 105 °C [-22 – 221 °F]
-----------------------------	-----------------------------

Operation/Application

Circuit Application	Power & Signal
---------------------	----------------

Other

EU RoHS Compliance	Compliant
--------------------	-----------



EU ELV Compliance

Compliant

Product Compliance

[For compliance documentation, visit the product page on TE.com>](#)

EU RoHS Directive 2011/65/EU	Compliant
EU ELV Directive 2000/53/EC	Compliant
China RoHS 2 Directive MIIT Order No 32, 2016	No Restricted Materials Above Threshold
EU REACH Regulation (EC) No. 1907/2006	Current ECHA Candidate List: JUNE 2024 (241) Candidate List Declared Against: JUNE 2024 (241) Does not contain REACH SVHC
Halogen Content	Low Halogen - Br, Cl, F, I < 900 ppm per homogenous material. Also BFR/CFR/PVC Free
Solder Process Capability	Not applicable for solder process capability

Product Compliance Disclaimer

This information is provided based on reasonable inquiry of our suppliers and represents our current actual knowledge based on the information they provided. This information is subject to change. The part numbers that TE has identified as EU RoHS compliant have a maximum concentration of 0.1% by weight in homogenous materials for lead, hexavalent chromium, mercury, PBB, PBDE, DBP, BBP, DEHP, DIBP, and 0.01% for cadmium, or qualify for an exemption to these limits as defined in the Annexes of Directive 2011/65/EU (RoHS2). Finished electrical and electronic equipment products will be CE marked as required by Directive 2011/65/EU. Components may not be CE marked. Additionally, the part numbers that TE has identified as EU ELV compliant have a maximum concentration of 0.1% by weight in homogenous materials for lead, hexavalent chromium, and mercury, and 0.01% for cadmium, or qualify for an exemption to these limits as defined in the Annexes of Directive 2000/53/EC (ELV). Regarding the REACH Regulation, the information TE provides on SVHC in articles for this part number is based on the latest European Chemicals Agency (ECHA) 'Guidance on requirements for substances in articles' posted at this URL: <https://echa.europa.eu/guidance-documents/guidance-on-reach>

Compatible Parts



TE Part # 2-292165-7
CT P/HDR BOX V 7P T/P BLUE



TE Part # 2-292254-7
CT RELAY HDR ASSY 7P BLUE



TE Part # 2-292174-7
CT BOX HDR V SMT 7P O/TAPE BLA



TE Part # 2-292132-7
CT P/HDR BOX V 7P BLUE

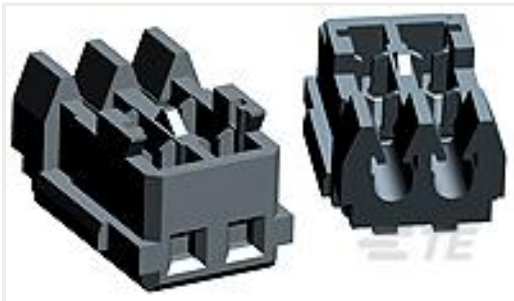

TE Part # 5-292271-7
MT REC ASSY AU-PL. 7P BLUE

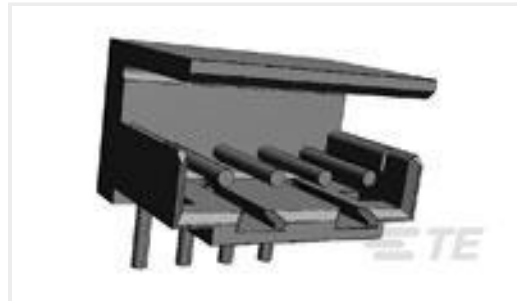

TE Part # 2-292250-7
CT P/HDR BOX H ASSY 7P W/KINK

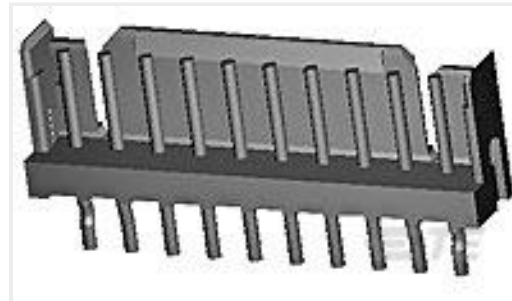

TE Part # 2-292161-7
CT P/HDR ASSY V 7P W/KINK BLUE



TE Part # 2-292164-7
CT P/HDR BOX H ASSY 7P T/P BLU



TE Part # CAT-3980407-RHDRRA
CT 2mm Header Assembly: Right Angle



TE Part # 2-292173-7
CT BOX HDR H SMT 7P O/TAPE BLA

Also in the Series | AMP CT



Connector Contacts(8)



Connector Hardware(46)

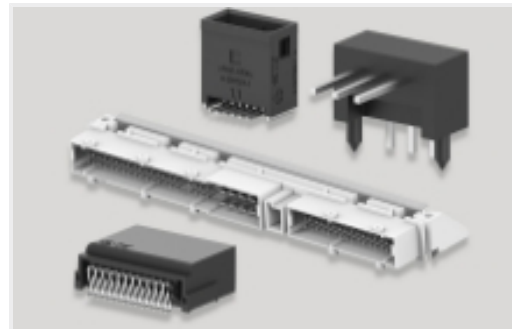

PCB Headers & Receptacles(756)



Wire-to-Board Connector Assemblies & Housings(255)

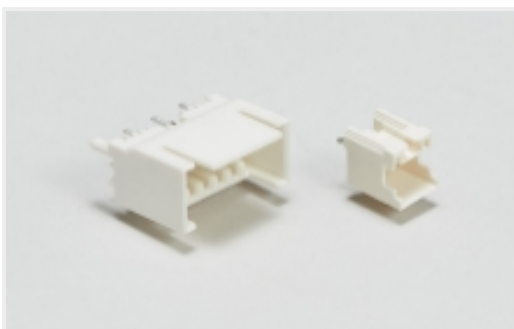

Wire-to-Board Headers & Receptacles (756)

Customers Also Bought

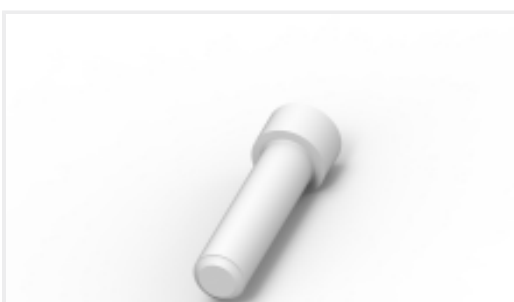

TE Part #114017-ZZ
SEALING PLUG, SIZE 12/16, WHT



TE Part #CAT-AM71-CH8172
AMP SUPERSEAL 1.5MM,
CONNECTOR HOUSING



TE Part #DT04-2P
REC, 2P, GRY, N



TE Part #DT06-2S
PLG, 2P, GRY, N



TE Part #CAT-D487-W416
Wedgelocks: DEUTSCH DT

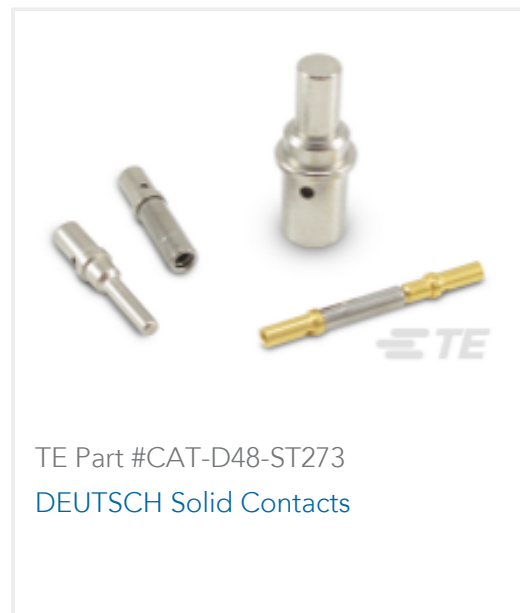

TE Part #CAT-D48-ST273
DEUTSCH Solid Contacts



TE Part #281934-2
SINGLE WIRE SEAL

Documents

Product Drawings

[CT CRIMP-2 REC HSG 7P BLUE](#)

English

CAD Files

[3D PDF](#)

3D

Customer View Model

[ENG_CVM_CVM_2-179228-7_N1.2d_dxf.zip](#)

English

Customer View Model

[ENG_CVM_CVM_2-179228-7_N1.3d_igs.zip](#)

English

Customer View Model

[ENG_CVM_CVM_2-179228-7_N1.3d_stp.zip](#)

English

By downloading the CAD file I accept and agree to the [Terms and Conditions](#) of use.

Product Specifications

[Crimping of AMP 2.0mm Pitch, CT Crimp Typell Rec Contact](#)

English

[Application Specification](#)

English

Agency Approvals

[CSA Certificate](#)

English

[CSA Certificate](#)

English