

2-1747066-2 ✓ ACTIVE

GRACE INERTIA 2.5

TE Internal #: 2-1747066-2

Housing, Plug, Wire-to-Board, 2 Position, 2.5 mm [.098 in]

Centerline, 1 Row, 50 VAC, Wire & Cable, GRACE INERTIA 2.5,

Standard Rectangular Connectors

[View on TE.com >](#)



Connectors > Rectangular Connectors > Standard Rectangular Connectors > STD Temp Sig GRACE INERTIA Plug

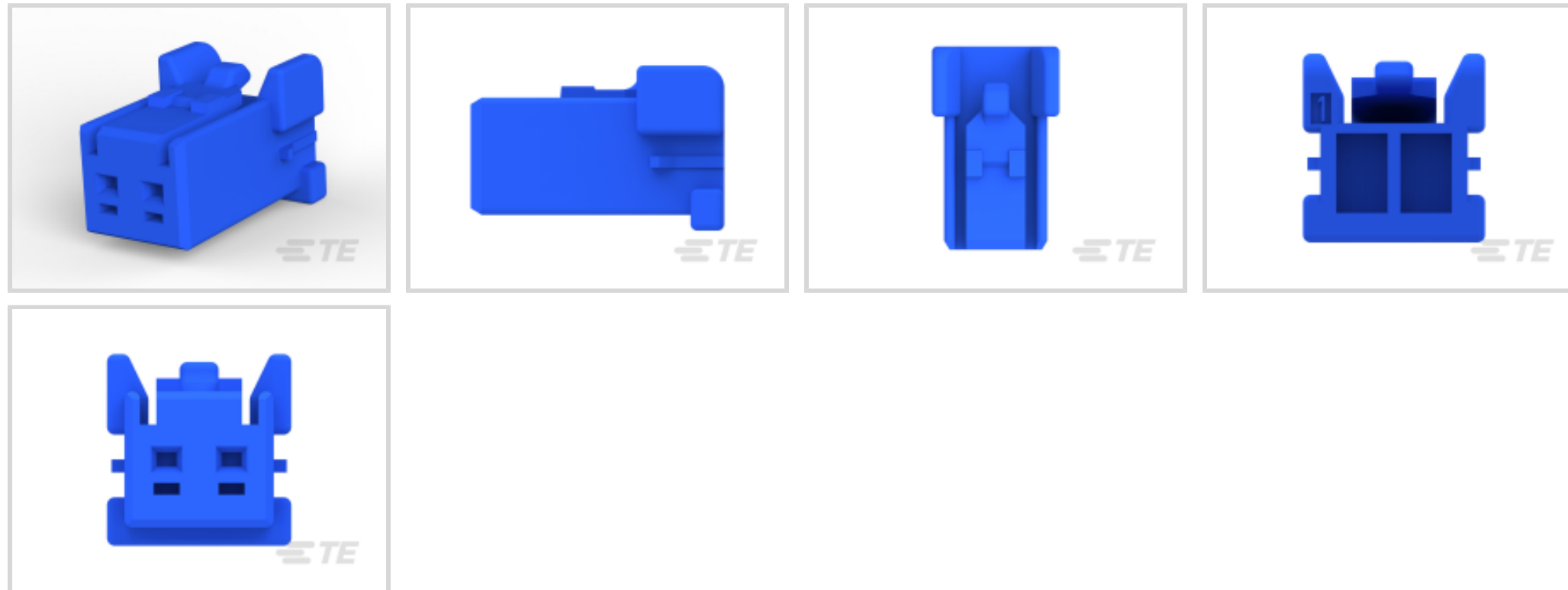

Connector Product Type: **Housing**

Connector & Housing Type: **Plug**

Connector System: **Wire-to-Board**

Number of Positions: **2**

Centerline (Pitch): **2.5 mm [.098 in]**

[All STD Temp Sig GRACE INERTIA Plug \(63\)](#)

Features

Body Features

Primary Product Color	Blue
-----------------------	------

Identification Marking

Circuit Identification Feature	Without
--------------------------------	---------

Contact Features

Contact Layout	Inline
Contact Type	Socket

Packaging Features

Packaging Method	Bag
Packaging Quantity	1000

Dimensions

Connector Width	7.1 mm[.279 in]
Connector Height	11.3 mm[.445 in]



Connector Length	7.1 mm[.279 in]
------------------	-----------------

Operation/Application

Halogen Free	No
Circuit Application	Signal

Electrical Characteristics

Operating Voltage	50 VAC
-------------------	--------

Housing Features

Housing Material	Nylon 66 GF
Centerline (Pitch)	2.5 mm[.098 in]

Product Type Features

Connector Product Type	Housing
Connector & Housing Type	Plug
Connector System	Wire-to-Board
Sealable	No
Connector & Contact Terminates To	Wire & Cable

Configuration Features

Number of Positions	2
Number of Rows	1

Mechanical Attachment

Connector Mounting Type	Cable Mount (Free-Hanging)
-------------------------	----------------------------

Usage Conditions

Operating Temperature Range	-30 – 105 °C[-22 – 221 °F]
-----------------------------	----------------------------

Other

EU RoHS Compliance	Compliant
EU ELV Compliance	Compliant

Product Compliance

[For compliance documentation, visit the product page on TE.com>](#)

EU RoHS Directive 2011/65/EU	Compliant
EU ELV Directive 2000/53/EC	Compliant
China RoHS 2 Directive MIIT Order No 32, 2016	No Restricted Materials Above Threshold
EU REACH Regulation (EC) No. 1907/2006	



Current ECHA Candidate List: JUNE 2024 (241)
 Candidate List Declared Against: JUNE 2024 (241)
 Does not contain REACH SVHC

Halogen Content Not Low Halogen - contains Br or Cl > 900 ppm.

Solder Process Capability Not applicable for solder process capability

Product Compliance Disclaimer

This information is provided based on reasonable inquiry of our suppliers and represents our current actual knowledge based on the information they provided. This information is subject to change. The part numbers that TE has identified as EU RoHS compliant have a maximum concentration of 0.1% by weight in homogenous materials for lead, hexavalent chromium, mercury, PBB, PBDE, DBP, BBP, DEHP, DIBP, and 0.01% for cadmium, or qualify for an exemption to these limits as defined in the Annexes of Directive 2011/65/EU (RoHS2). Finished electrical and electronic equipment products will be CE marked as required by Directive 2011/65/EU. Components may not be CE marked. Additionally, the part numbers that TE has identified as EU ELV compliant have a maximum concentration of 0.1% by weight in homogenous materials for lead, hexavalent chromium, and mercury, and 0.01% for cadmium, or qualify for an exemption to these limits as defined in the Annexes of Directive 2000/53/EC (ELV). Regarding the REACH Regulation, the information TE provides on SVHC in articles for this part number is based on the latest European Chemicals Agency (ECHA) 'Guidance on requirements for substances in articles' posted at this URL: <https://echa.europa.eu/guidance-documents/guidance-on-reach>

Compatible Parts

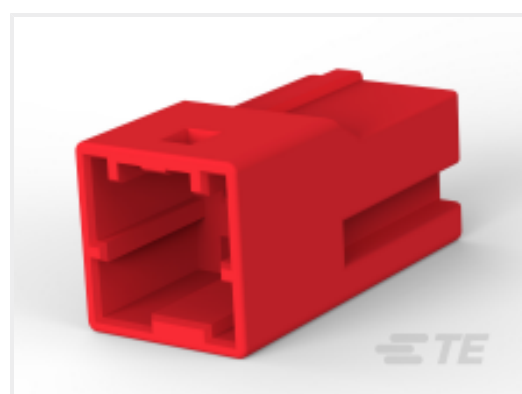

TE Part # 1-1903391-2
 GIC 2.5 W CAP HSG 2P RED



TE Part # CAT-G7534A-C1701
 STD Temp Sig GRACE INERTIA Cap



TE Part # CAT-G7534A-P729
 STD Temp Sig GRACE INERTIA Plug



TE Part # 1903391-1
 GIC 2.5 W CAP HSG 2P NATURAL

Also in the Series | GRACE INERTIA 2.5



Connector Contacts(6)



Connector Hardware(7)

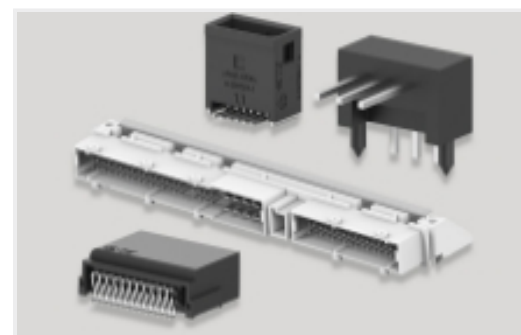

PCB Headers & Receptacles(173)



Power Contacts(2)

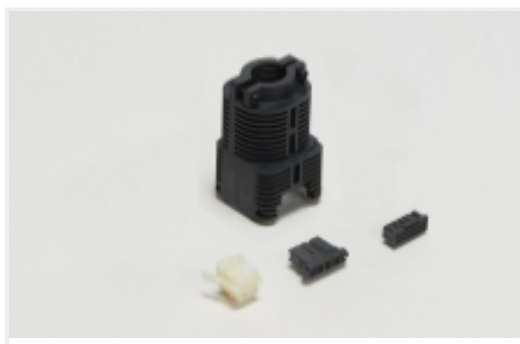

Rectangular Connector Housings(49)

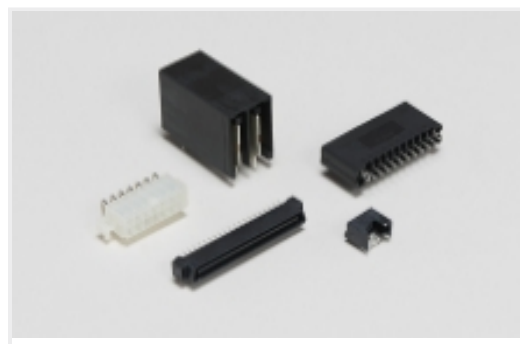

Standard Rectangular Connectors(49)

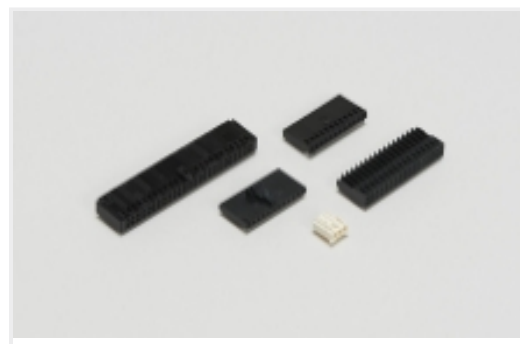

Wire-to-Board Connector Assemblies & Housings(47)

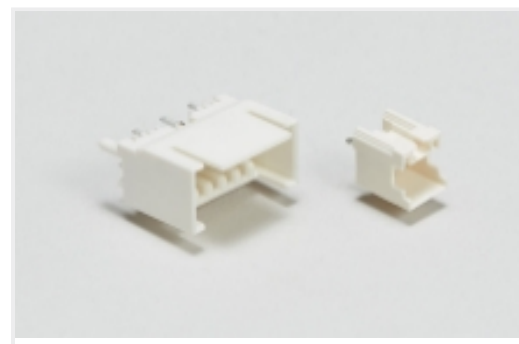

Wire-to-Board Headers & Receptacles (173)

Customers Also Bought

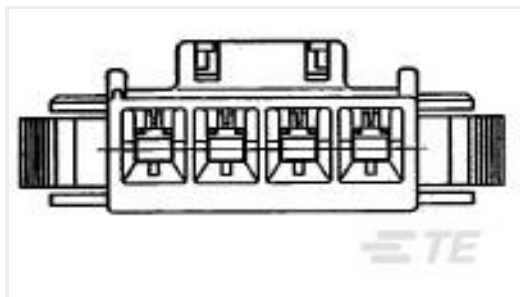

TE Part #178740-1
UP 3.96 CAP HSG PAN-MT NAT

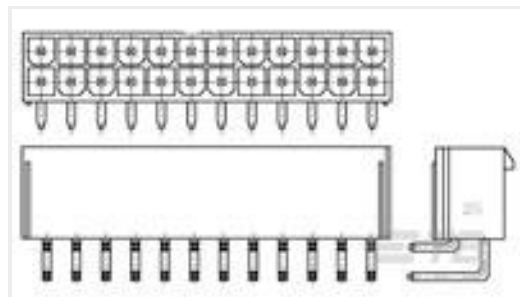

TE Part #1586863-2
2P VAL-U-LOK R/A HDR GW

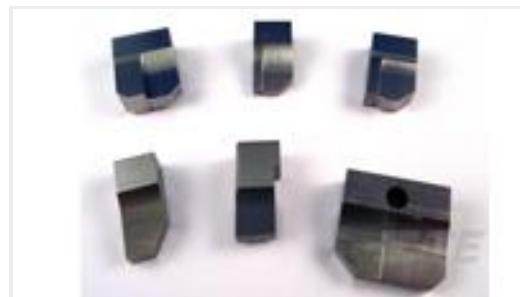

TE Part #1633387-5
ANVIL, COMBINATION



ANVIL REPRESENTATION ONLY
TE Part #3-1633134-5
ANVIL, COMBINATION .110



TE Part #1747062-1
GRACE INERTIA CONN 2.0 REC CONTACT

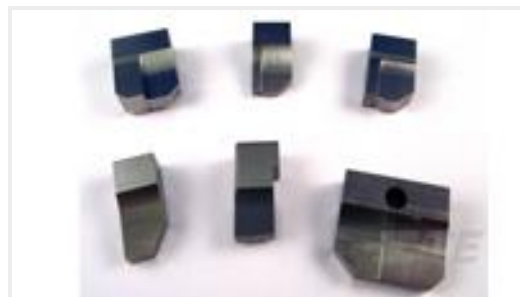

TE Part #722634-9
ANVIL

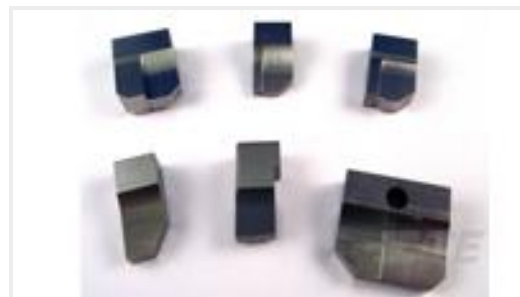

TE Part #409591-1
ANVIL

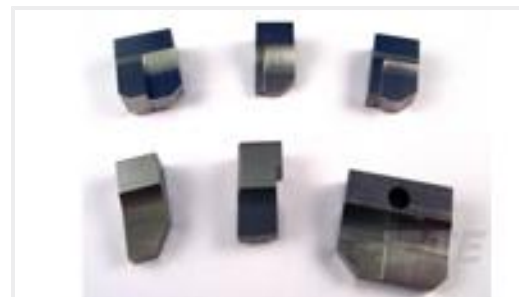

TE Part #1463047-4
ANVIL



TE Part #1-409414-9
CRIMPER WIRE



TE Part #2174308-1
POSITIVE LOCK EX .250 (6.3 MM)

Documents

Product Drawings

[GRACE INERTIA CONN 2.5 PLUG HSG 2P BLUE](#)

English

CAD Files

Customer View Model

[ENG_CVM_CVM_2-1747066-2_E.2d_dxf.zip](#)

English

[3D PDF](#)



3D

Customer View Model

[ENG_CVM_CVM_2-1747066-2_E.3d_igs.zip](#)

English

Customer View Model

[ENG_CVM_CVM_2-1747066-2_E.3d_stp.zip](#)

English

By downloading the CAD file I accept and agree to the [Terms and Conditions](#) of use.

Product Specifications

[Application Specification](#)

English