

2-173977-7 ✓ ACTIVE

AMP CT

TE Internal #: 2-173977-7

Connector Assembly, Receptacle, Wire-to-Board, 7 Position, 2 mm [.079 in] Centerline, Insulation Displacement (IDC), 1 Row, Blue, Wire & Cable, AMP CT

[View on TE.com >](#)



[Connectors >](#) [PCB Connectors >](#) [Wire-to-Board Connectors >](#) [Wire-to-Board Connector Assemblies & Housings >](#)

[AMP COMMON TERMINATION HOUSINGS](#)

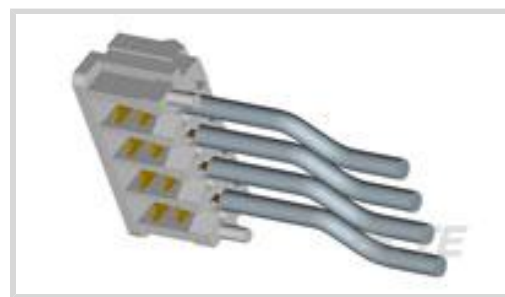

Connector Product Type: **Connector Assembly**

Connector & Housing Type: **Receptacle**

Connector System: **Wire-to-Board**

Number of Positions: **7**

Centerline (Pitch): **2 mm [.079 in]**

[All AMP COMMON TERMINATION HOUSINGS \(176\)](#)

Features

Electrical Characteristics

Termination Resistance	7 mΩ
------------------------	------

Dimensions

2 in

Housing Features

Housing Material	PBT GF
------------------	--------

Centerline (Pitch)	2 mm [.079 in]
--------------------	----------------

Product Type Features

Connector Product Type	Connector Assembly
------------------------	--------------------

Connector & Housing Type	Receptacle
--------------------------	------------

Connector System	Wire-to-Board
------------------	---------------

Sealable	No
----------	----

Connector & Contact Terminates To	Wire & Cable
-----------------------------------	--------------

Configuration Features

Number of Positions	7
---------------------	---

Number of Rows	1
----------------	---



Body Features

Primary Product Color	Blue
-----------------------	------

Contact Features

Contact Current Rating (Max)	2 A
------------------------------	-----

Termination Features

Termination Method to Wire & Cable	Insulation Displacement (IDC)
------------------------------------	-------------------------------

Mechanical Attachment

Mating Retention	Without
Connector Mounting Type	Cable Mount (Free-Hanging)

Usage Conditions

Operating Temperature Range	-30 – 105 °C[-22 – 221 °F]
-----------------------------	----------------------------

Operation/Application

Circuit Application	Power & Signal
---------------------	----------------

Other

EU RoHS Compliance	Compliant
EU ELV Compliance	Compliant

Product Compliance

[For compliance documentation, visit the product page on TE.com>](#)

EU RoHS Directive 2011/65/EU	Compliant
EU ELV Directive 2000/53/EC	Compliant
China RoHS 2 Directive MIIT Order No 32, 2016	No Restricted Materials Above Threshold
EU REACH Regulation (EC) No. 1907/2006	Current ECHA Candidate List: JUNE 2024 (241) Candidate List Declared Against: JUNE 2024 (241) Does not contain REACH SVHC
Halogen Content	Not Low Halogen - contains Br or Cl > 900 ppm.
Solder Process Capability	Not applicable for solder process capability

Product Compliance Disclaimer

This information is provided based on reasonable inquiry of our suppliers and represents our current actual knowledge based on the information they provided. This information is subject to change. The part numbers that TE has identified as EU RoHS compliant have a maximum concentration of 0.1% by weight in homogenous materials for lead, hexavalent chromium, mercury, PBB, PBDE, DBP, BBP, DEHP, DIBP, and 0.01% for cadmium, or qualify for an exemption to these

limits as defined in the Annexes of Directive 2011/65/EU (RoHS2). Finished electrical and electronic equipment products will be CE marked as required by Directive 2011/65/EU. Components may not be CE marked. Additionally, the part numbers that TE has identified as EU ELV compliant have a maximum concentration of 0.1% by weight in homogenous materials for lead, hexavalent chromium, and mercury, and 0.01% for cadmium, or qualify for an exemption to these limits as defined in the Annexes of Directive 2000/53/EC (ELV). Regarding the REACH Regulation, the information TE provides on SVHC in articles for this part number is based on the latest European Chemicals Agency (ECHA) 'Guidance on requirements for substances in articles' posted at this URL: <https://echa.europa.eu/guidance-documents/guidance-on-reach>

Compatible Parts

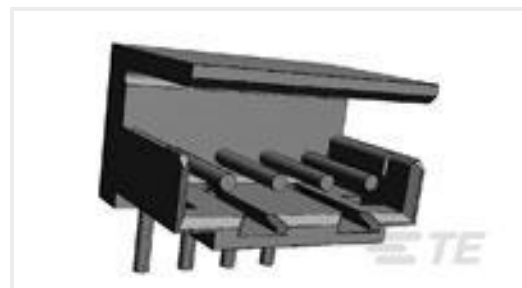

TE Part # 2-292164-7
CT P/HDR BOX H ASSY 7P T/P BLU



TE Part # 2-173983-7
AMP CT MT AMP-IN HDR-H YEL 7P



TE Part # CAT-3980407-RHDXRA
CT 2mm Header Assembly: Right Angle

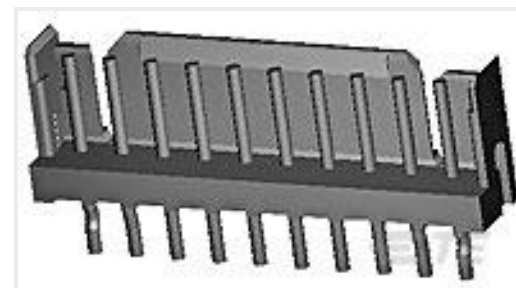

TE Part # 2-292145-7
CT P/HDR ASSY V 7P W/O KINK BL

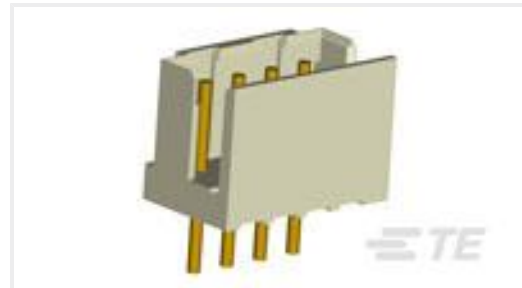

TE Part # 2-292165-7
CT P/HDR BOX V 7P T/P BLUE

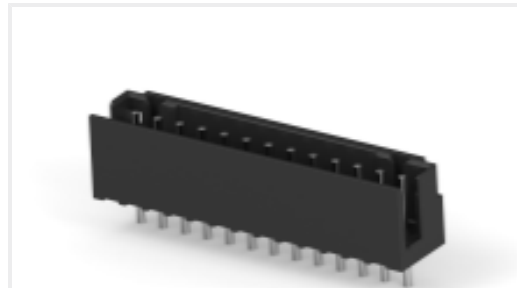

TE Part # CAT-3983178-PHBXVD
CT 2mm Post Header Asmby: Box V DIP



TE Part # 2-292254-7
CT RELAY HDR ASSY 7P BLUE



TE Part # CAT-3984552-BHTHVS
CT Box Header SMT: Vert, Shrouded



TE Part # 58372-1
HEAD (IDC) 2MM C.T. W/O TL

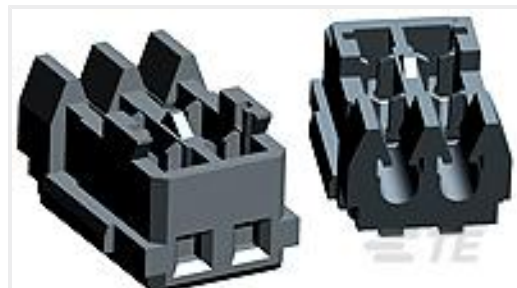

TE Part # 5-292271-7
MT REC ASSY AU-PL. 7P BLUE



TE Part # CAT-3983174-PHBXHK
CT 2mm Post Header Assembly Box H Kink



TE Part # 292254-7
CT RELAY HDR ASSY 7P NAT

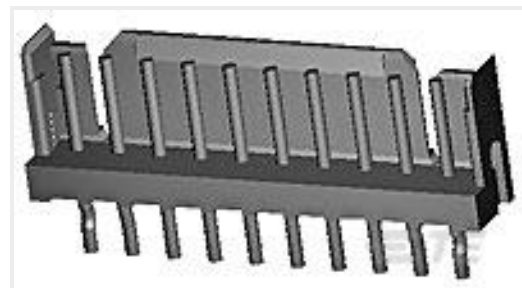

TE Part # 2-292161-7
CT P/HDR ASSY V 7P W/KINK BLUE



TE Part # 2-173985-7
AMP CT MT AMP-IN HDR-V BLU 7P



TE Part # 58074-1
MTA 50/100/156 MANUAL TOOL FRAME

Also in the Series | **AMP CT**



Connector Contacts(8)



Connector Hardware(46)

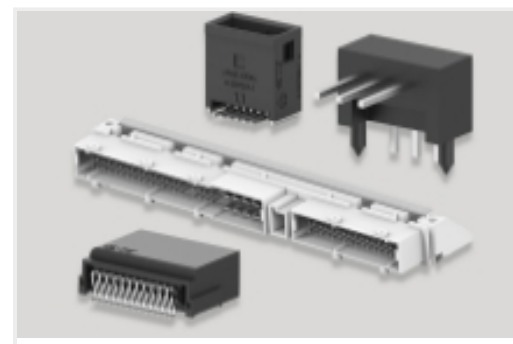

PCB Headers & Receptacles(756)

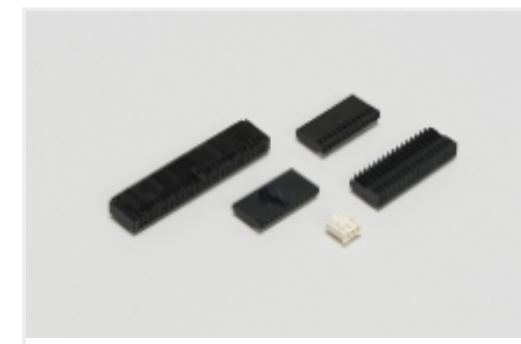
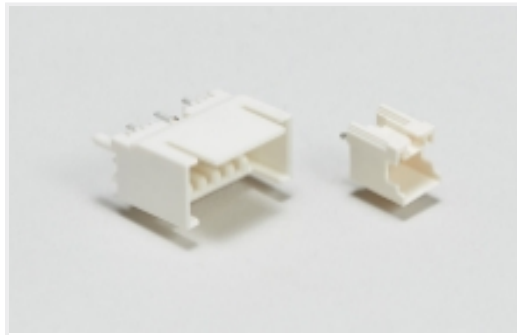
Wire-to-Board Connector Assemblies
& Housings(255)Wire-to-Board Headers & Receptacles
(756)

Customers Also Bought

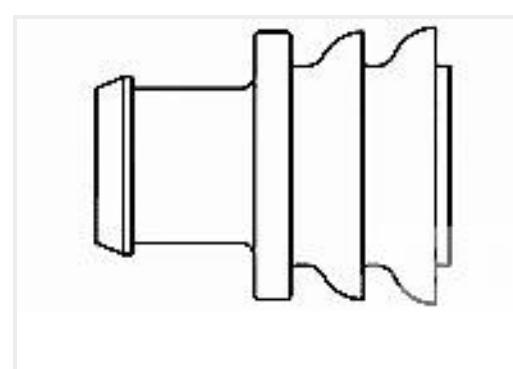
TE Part #114017-ZZ
SEALING PLUG, SIZE 12/16, WHTTE Part #DT04-2P
REC, 2P, GRY, NTE Part #DT06-2S
PLG, 2P, GRY, NTE Part #CAT-D487-W416
WedgeLocks: DEUTSCH DTTE Part #CAT-D48-ST273
DEUTSCH Solid ContactsTE Part #CAT-AM71-CH8172
AMP SUPERSEAL 1.5MM,
CONNECTOR HOUSINGTE Part #281934-2
SINGLE WIRE SEAL

Documents

CAD Files

Customer View Model

[ENG_CVM_CVM_2-173977-7_M.2d_dxf.zip](#)

English

3D PDF

3D

Customer View Model

[ENG_CVM_CVM_2-173977-7_M.3d_igs.zip](#)



English

Customer View Model

[ENG_CVM_CVM_2-173977-7_M.3d_stp.zip](#)

English

By downloading the CAD file I accept and agree to the [Terms and Conditions](#) of use.

Product Specifications

[Application Specification](#)

English

Instruction Sheets

[MINI PRESS CT CONNECTOR \(WAS IS-553J\)](#)

Japanese

[Instruction Sheet \(non U.S.\)](#)

Japanese

Agency Approvals

[CSA Certificate](#)

English

[CSA Certificate](#)

English