

1SNA290354R1100 ✓ ACTIVE

TE Internal #: 1SNA290354R1100

TE Internal Description: D2.5/5.C4.L

[View on TE.com >](#)



Product Compliance

[For compliance documentation, visit the product page on TE.com>](#)

EU RoHS Directive 2011/65/EU	Compliant
EU ELV Directive 2000/53/EC	Compliant
China RoHS 2 Directive MIIT Order No 32, 2016	有害物质含量符合标准要求 No Restricted Substance(s) Above Threshold
EU REACH Regulation (EC) No. 1907/2006	Current ECHA Candidate List: JUNE 2025 (250) Candidate List Declared Against: JUNE 2025 (250) Does not contain REACH SVHC
Halogen Content	Low Halogen - Br, Cl, F < 900 ppm per homogenous material. Also BFR/CFR/PVC Free
Solder Process Capability	Not reviewed for solder process capability

Product Compliance Disclaimer

This information is provided based on reasonable inquiry of our suppliers and represents our current actual knowledge based on the information they provided. This information is subject to change. The part numbers that TE has identified as EU RoHS compliant have a maximum concentration of 0.1% by weight in homogenous materials for lead, hexavalent chromium, mercury, PBB, PBDE, DBP, BBP, DEHP, DIBP, and 0.01% for cadmium, or qualify for an exemption to these limits as defined in the Annexes of Directive 2011/65/EU (RoHS2). Finished electrical and electronic equipment products will be CE marked as required by Directive 2011/65/EU. Components may not be CE marked. Additionally, the part numbers that TE has identified as EU ELV compliant have a maximum concentration of 0.1% by weight in homogenous materials for lead, hexavalent chromium, and mercury, and 0.01% for cadmium, or qualify for an exemption to these limits as defined in the Annexes of Directive 2000/53/EC (ELV). Regarding the REACH Regulation, the information TE provides on SVHC in articles for this part number is based on the latest European Chemicals Agency (ECHA) 'Guidance on requirements for substances in articles' posted at this URL: <https://echa.europa.eu/guidance-documents/guidance-on-reach>

Compatible Parts

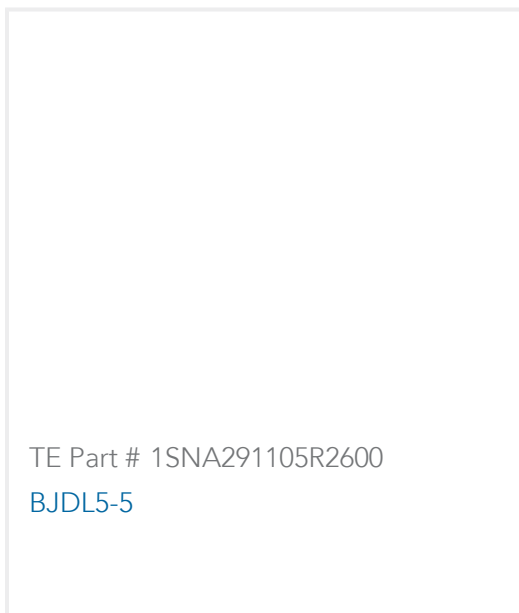

TE Part # 1SNA291105R2600
BJDLS-5



TE Part # 1SNA291108R0100
BJDLS-8

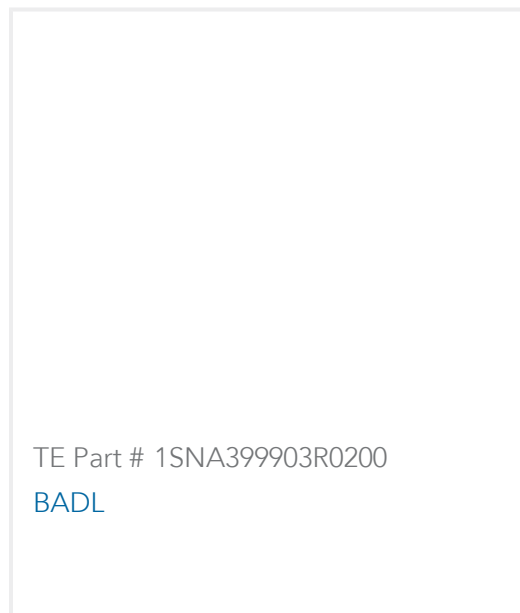

TE Part # 1SNA399903R0200
BADL

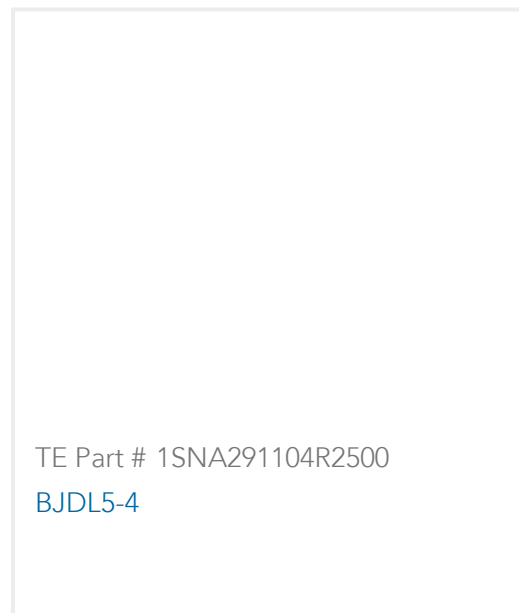

TE Part # 1SNA291104R2500
BJDLS-4

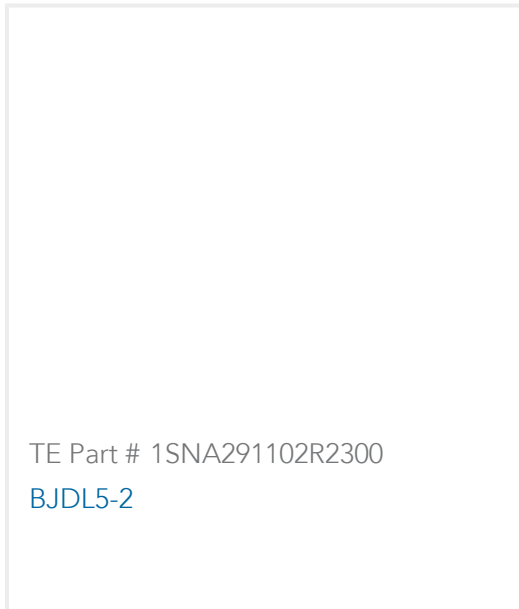

TE Part # 1SNA291102R2300
BJDLS-2



TE Part # 1SNA174300R1700
PR3.Z2



TE Part # 1SNA291109R0200
BJDLS-9



TE Part # 1SNA291107R2000
BJDLS-7

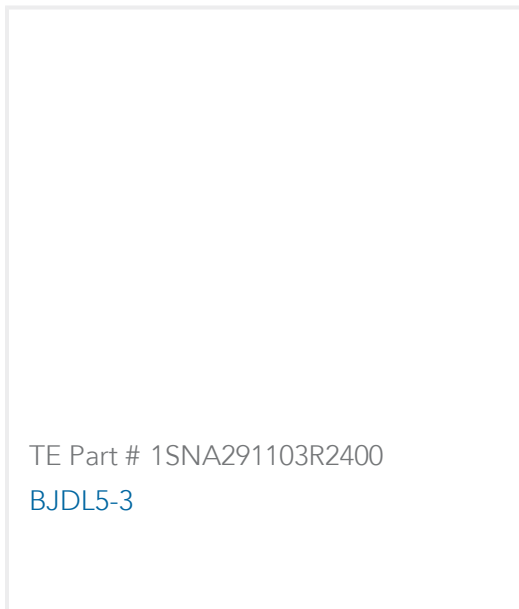

TE Part # 1SNA291103R2400
BJDLS-3



TE Part # 1SNA168500R1200
PR4

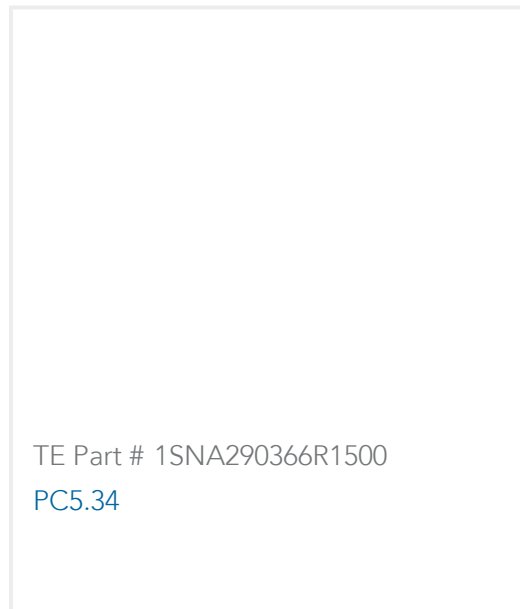

TE Part # 1SNA290366R1500
PC5.34

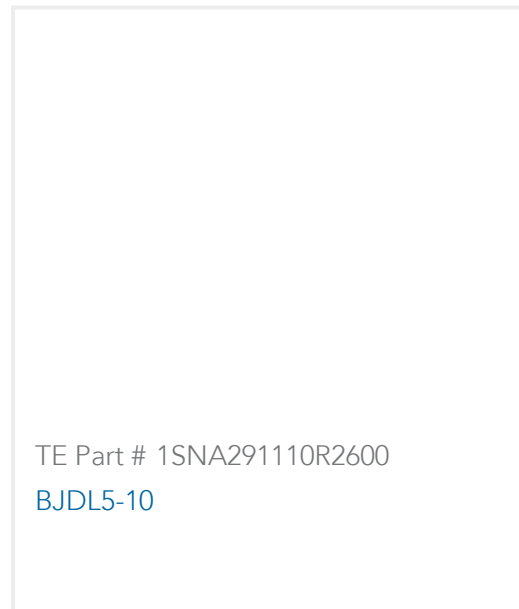

TE Part # 1SNA291110R2600
BJDLS-10

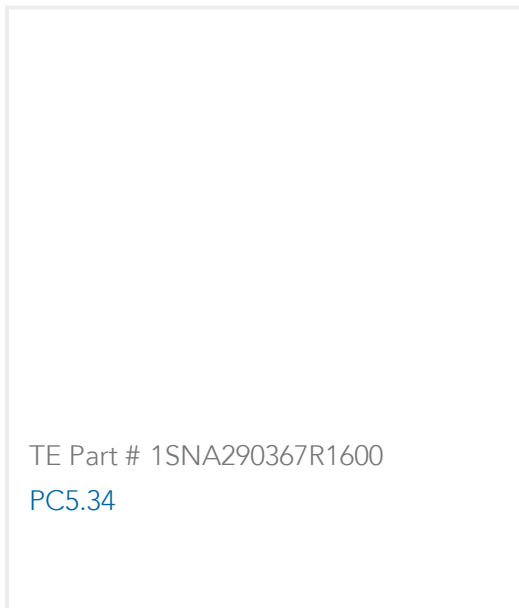

TE Part # 1SNA290367R1600
PC5.34

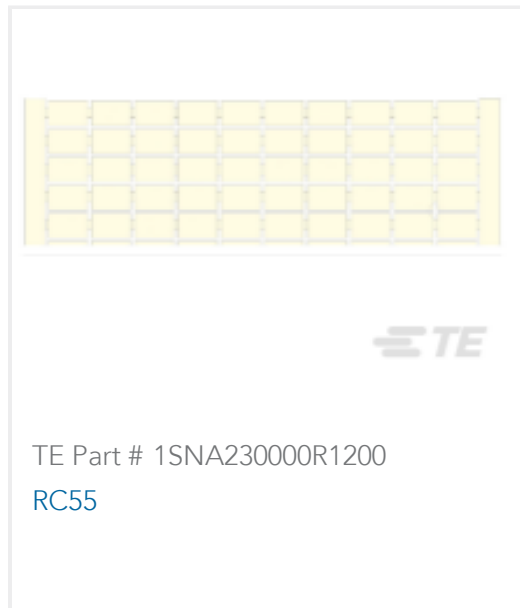

TE Part # 1SNA230000R1200
RC55

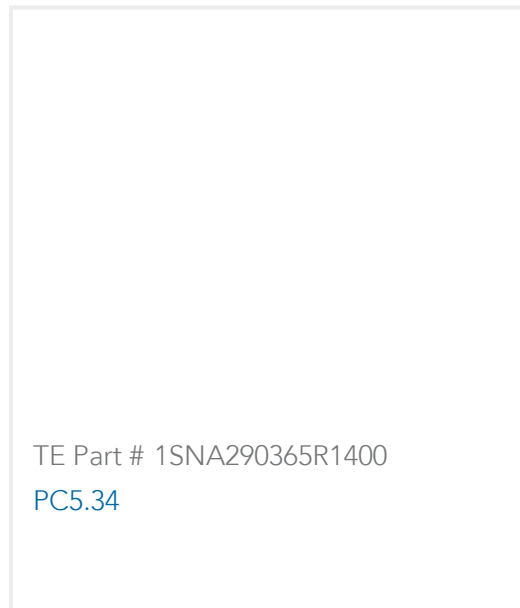

TE Part # 1SNA290365R1400
PC5.34

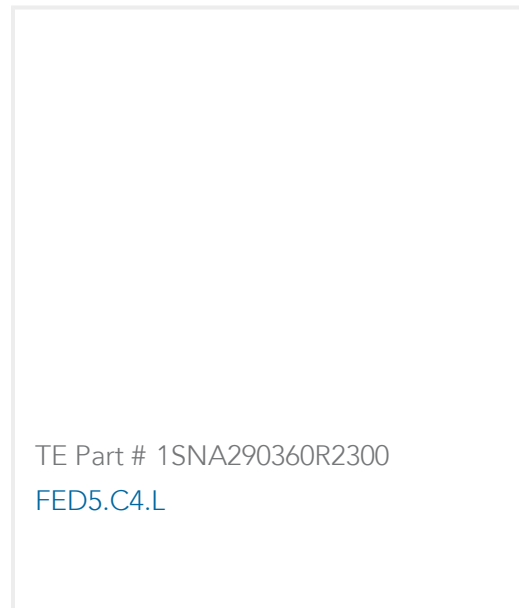

TE Part # 1SNA290360R2300
FED5.C4.L

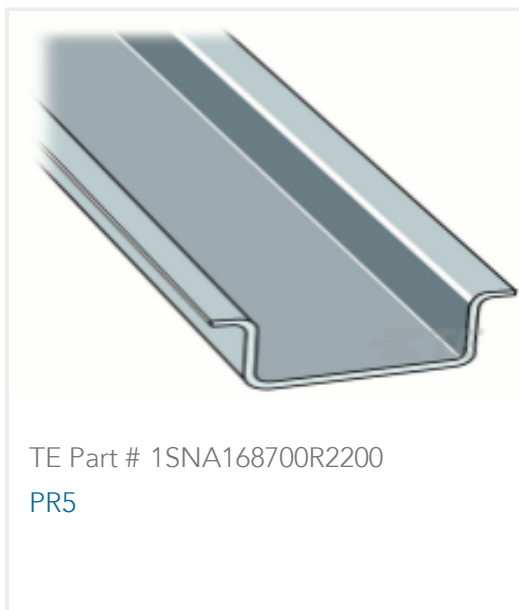

TE Part # 1SNA168700R2200
PR5



TE Part # 1SNA291106R2700
BJDLS-6

Customers Also Bought



TE Part #CAT-C73765-M1E
M12 Field Installable Unshielded



TE Part #T4131012081-000
M12,REAR MOUNT,FEMALE,A,8P,
SOLDER WIRE



TE Part #5-747904-2
9 Plug Solder Cup, Gold Flash,



TE Part #5-747905-2
9 Rcpt Solder Cup, Gold Flash,

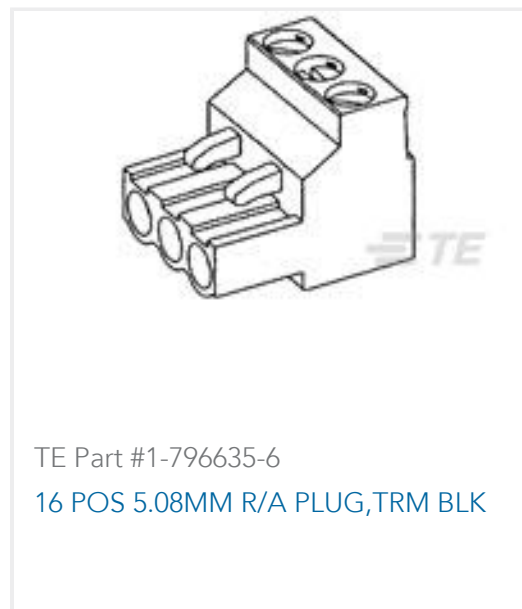

TE Part #1-796635-6
16 POS 5.08MM R/A PLUG,TRM BLK



TE Part #796644-4
4POS 5.0MM CE R/A HDR,TRM BLK



TE Part #1551629-3
MICRO USB, TYPE A/B,
SPLASHPROOF LOW MOQ

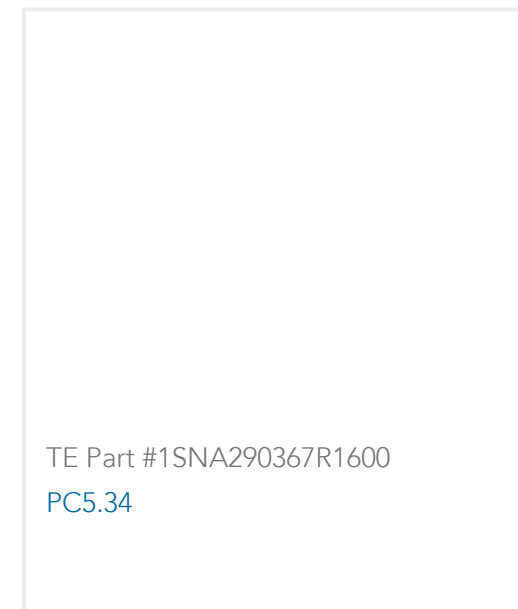

TE Part #1SNA290367R1600
PC5.34

Documents

Datasheets & Catalog Pages

[ENTRELEC Terminal Block - Master Catalog](#)

[ENTRELEC Terminal Block - Master Catalog](#)

English

[Entrelec-sensor-actuator](#)

English

[ENTRELEC Terminal Blocks Catalogue \(RUS\)](#)