

1825360-1 ✓ ACTIVE

ALCOSWITCH | ALCOSWITCH DIP, ALCOSWITCH DIP ADE

TE Internal #: 1825360-1

DIP Switch, Gold Flash Contact Plating, Black, Polyphenylene

Sulfide (PPS), 2 Switch, -30 – 85 °C [-22 – 185 °F], ALCOSWITCH DIP

[View on TE.com >](#)



Switches > DIP & SIP Switches

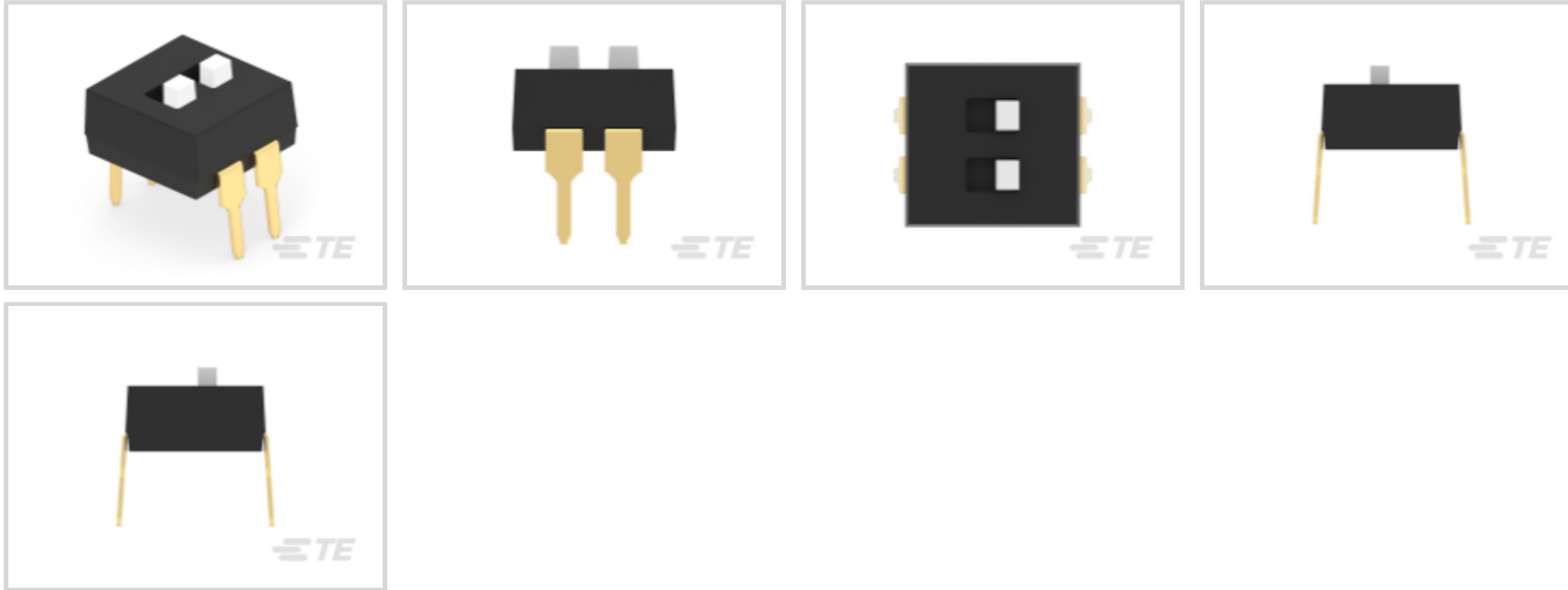

Switch Contact Plating Material: **Gold Flash**

Case Color: **Black**

Case Material: **Polyphenylene Sulfide (PPS)**

Sealed Device: **No**

Number of Switches: **2**

Features

Product Type Features

Sealed Device	No
DIP & SIP Switch Type	DIP
Actuator Style	Extended Actuator, Slide Actuator

Configuration Features

Number of Positions	2
Number of Switches	2
Configuration (Pole-Throw)	Single Pole - Single Throw

Electrical Characteristics

Contact Current Rating	1 A
Operating Voltage	5 VDC

Body Features

Actuator Color	White
Product Orientation	Vertical
Case Color	Black



Case Material	Polyphenylene Sulfide (PPS)
---------------	-----------------------------

Contact Features

	1.2 μin
Contact Underplating Material	Nickel
PCB Contact Termination Area Plating Material	Gold
Switch Contact Plating Material	Gold Flash
Contact Base Material	Copper Alloy

Termination Features

Termination Post & Tail Length	4 mm[.157 in]
Termination Method to PCB	Through Hole - Solder

Housing Features

Centerline (Pitch)	2.54 mm[.1 in]
--------------------	----------------

Dimensions

Product Length	7.01 mm[.276 in]
Product Height	3.5 mm[.138 in]

Usage Conditions

Operating Temperature Range	-30 – 85 °C[-22 – 185 °F]
-----------------------------	---------------------------

Operation/Application

Assembly Process Feature	Auto-Insert Packaging
--------------------------	-----------------------

Industry Standards

UL Flammability Rating	UL 94V-0
------------------------	----------

Packaging Features

Packaging Method	Tube
Packaging Quantity	60

Product Compliance

[For compliance documentation, visit the product page on TE.com>](#)

EU RoHS Directive 2011/65/EU	Compliant
EU ELV Directive 2000/53/EC	Compliant
China RoHS 2 Directive MIIT Order No 32, 2016	有害物质含量符合标准要求 No Restricted Substance(s) Above Threshold
EU REACH Regulation (EC) No. 1907/2006	



Current ECHA Candidate List: JUNE 2025 (250)
 Candidate List Declared Against: JAN 2024 (240)
 Does not contain REACH SVHC

Halogen Content BFR/CFR/PVC Free, but Br/Cl >900 ppm in other sources.

Solder Process Capability Wave solder capable to 265°C

Product Compliance Disclaimer

This information is provided based on reasonable inquiry of our suppliers and represents our current actual knowledge based on the information they provided. This information is subject to change. The part numbers that TE has identified as EU RoHS compliant have a maximum concentration of 0.1% by weight in homogenous materials for lead, hexavalent chromium, mercury, PBB, PBDE, DBP, BBP, DEHP, DIBP, and 0.01% for cadmium, or qualify for an exemption to these limits as defined in the Annexes of Directive 2011/65/EU (RoHS2). Finished electrical and electronic equipment products will be CE marked as required by Directive 2011/65/EU. Components may not be CE marked. Additionally, the part numbers that TE has identified as EU ELV compliant have a maximum concentration of 0.1% by weight in homogenous materials for lead, hexavalent chromium, and mercury, and 0.01% for cadmium, or qualify for an exemption to these limits as defined in the Annexes of Directive 2000/53/EC (ELV). Regarding the REACH Regulation, the information TE provides on SVHC in articles for this part number is based on the latest European Chemicals Agency (ECHA) 'Guidance on requirements for substances in articles' posted at this URL: <https://echa.europa.eu/guidance-documents/guidance-on-reach>

Compatible Parts



TE Part # 1825057-4
 ADE0504=DIP SWITCH,EXT,THRU/HL



TE Part # 1825057-1
 ADE0204=DIP SWITCH,EXT,THRU/HL

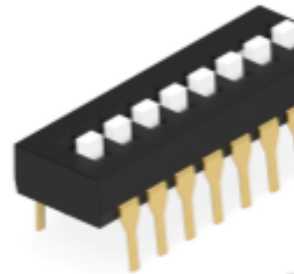

TE Part # 1825057-7
 ADE0804=DIP SWITCH,EXT,THRU/HL

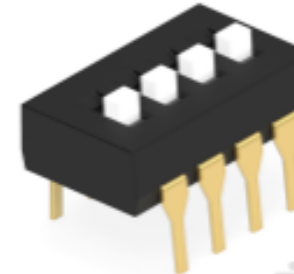

TE Part # 1825057-3
 ADE0404=DIP SWITCH,EXT,THRU/HL

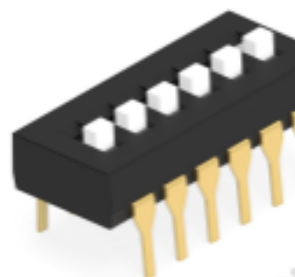

TE Part # 1825057-5
 ADE0604=DIP SWITCH,EXT,THRU/HL

Also in the Series | **ALCOSWITCH DIP**

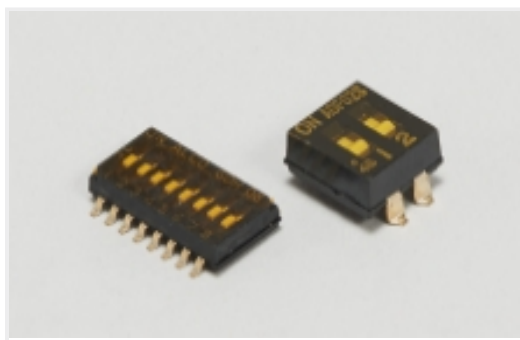

DIP & SIP Switches(26)



Rotary Switches(16)

Also in the Series | **ALCOSWITCH DIP ADE**

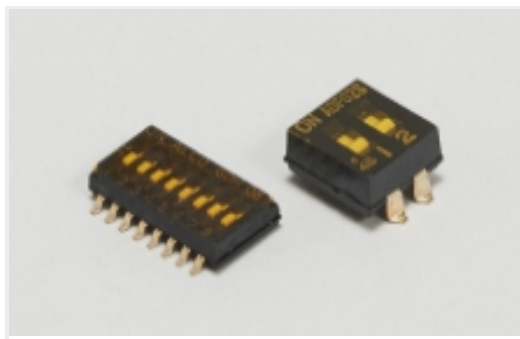

DIP & SIP Switches(26)

Customers Also Bought



TE Part #ZPF000000000007770
983-OWS 12-12 PN



TE Part #ZPF000000000007778
983-OWS 14-15 PN



TE Part #1-1734328-2
Mini USB AB R/A,Rcpt,SMT,T&R, 0.6 mm



TE Part #1879353-6
RR02 5% 6K8 AMMO



TE Part #4-2176403-4
3550 62R 1%



TE Part #7-2176529-5
3504G 3A 301R 1% 1K RL



TE Part #2351886-6
6POS TB HDR 180 DEG, PITCH 3.5, TL 3.4mm



TE Part #5536386-5
ASSY,PIN,EUROCARD,TYPE B/2,LEA



TE Part #5536446-5
ASSEMBLY,RECEPTACLE,EUROCARD, T

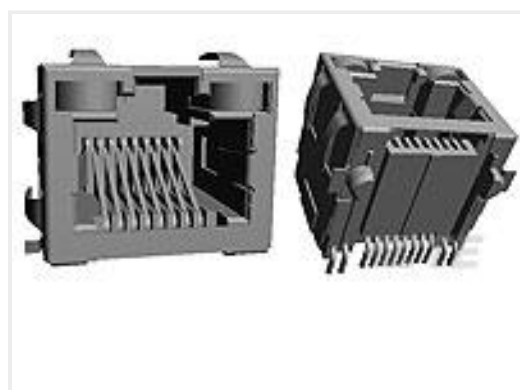

TE Part #6339191-1
MJ,RJ45,SMT,SHLD,LED (Y/G)



Documents

CAD Files

Customer View Model

[ENG_CVM_CVM_1825360-1_C.3d_igs.zip](#)

English

Customer View Model

[ENG_CVM_CVM_1825360-1_C.3d_stp.zip](#)

English

Customer View Model

[ENG_CVM_CVM_1825360-1_C.2d_dxf.zip](#)

English

3D PDF

3D

By downloading the CAD file I accept and agree to the [Terms and Conditions](#) of use.

Datasheets & Catalog Pages

[SWITCHES_CORE_PROGRAM_CATALOG](#)

English

[ADE_ADP_ADF_Datasheet](#)

English