

1801422-3 ✓ ACTIVE

AMP | NG1, NG Power Terminals and Connectors

TE Internal #: 1801422-3

TE Internal Description: RECEPT HOUSING ASSY, 8MM, 2 W

[View on TE.com >](#)



Product Compliance

[For compliance documentation, visit the product page on TE.com>](#)

EU RoHS Directive 2011/65/EU	Compliant
EU ELV Directive 2000/53/EC	Compliant
China RoHS 2 Directive MIIT Order No 32, 2016	No Restricted Materials Above Threshold
EU REACH Regulation (EC) No. 1907/2006	Current ECHA Candidate List: JUNE 2024 (241) Candidate List Declared Against: JAN 2022 (223) Does not contain REACH SVHC
Halogen Content	Low Halogen - Br, Cl, F, I < 900 ppm per homogenous material. Also BFR/CFR/PVC Free
Solder Process Capability	Not applicable for solder process capability

Product Compliance Disclaimer

This information is provided based on reasonable inquiry of our suppliers and represents our current actual knowledge based on the information they provided. This information is subject to change. The part numbers that TE has identified as EU RoHS compliant have a maximum concentration of 0.1% by weight in homogenous materials for lead, hexavalent chromium, mercury, PBB, PBDE, DBP, BBP, DEHP, DIBP, and 0.01% for cadmium, or qualify for an exemption to these limits as defined in the Annexes of Directive 2011/65/EU (RoHS2). Finished electrical and electronic equipment products will be CE marked as required by Directive 2011/65/EU. Components may not be CE marked. Additionally, the part numbers that TE has identified as EU ELV compliant have a maximum concentration of 0.1% by weight in homogenous materials for lead, hexavalent chromium, and mercury, and 0.01% for cadmium, or qualify for an exemption to these limits as defined in the Annexes of Directive 2000/53/EC (ELV). Regarding the REACH Regulation, the information TE provides on SVHC in articles for this part number is based on the latest European Chemicals Agency (ECHA) 'Guidance on requirements for substances in articles' posted at this URL: <https://echa.europa.eu/guidance-documents/guidance-on-reach>

Compatible Parts



Also in the Series | NG1

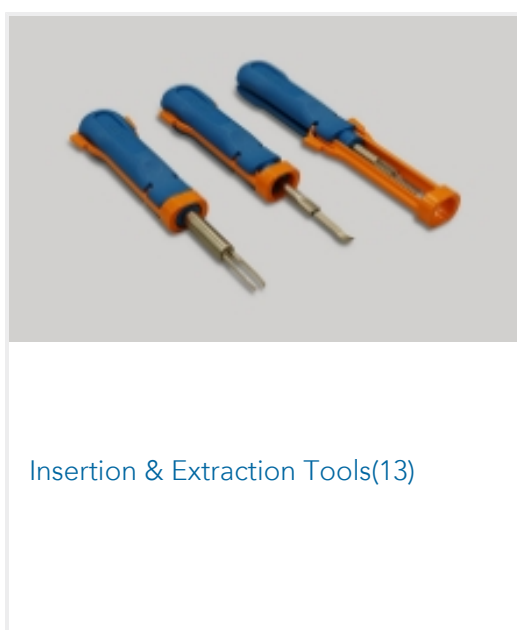
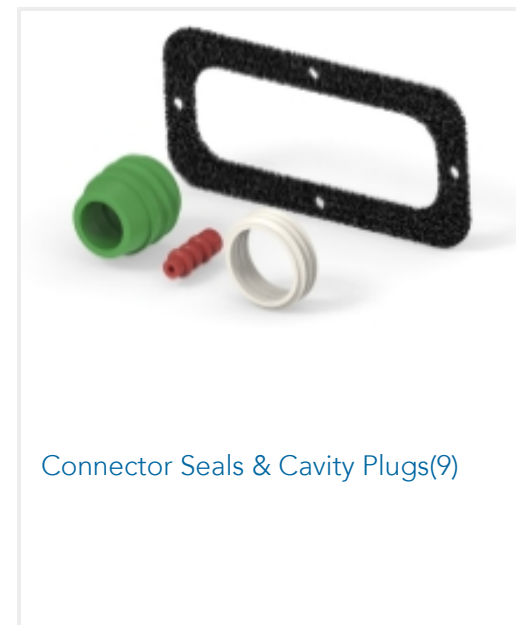
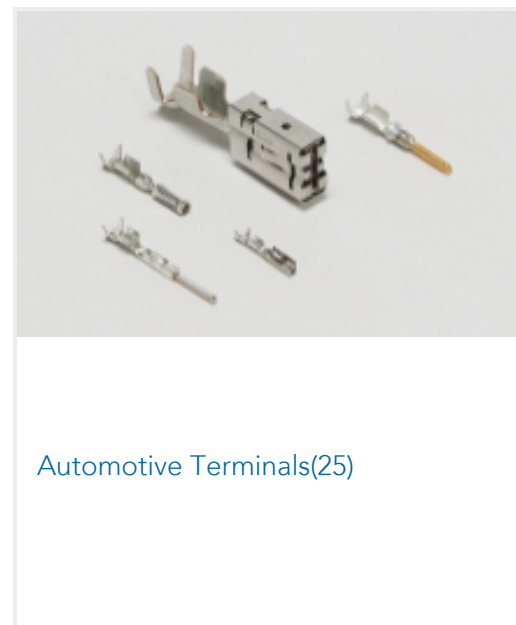
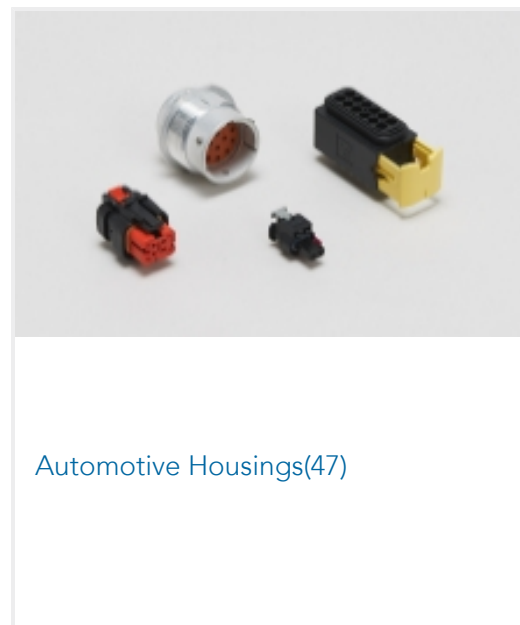

Also in the Series | NG Power Terminals and Connectors

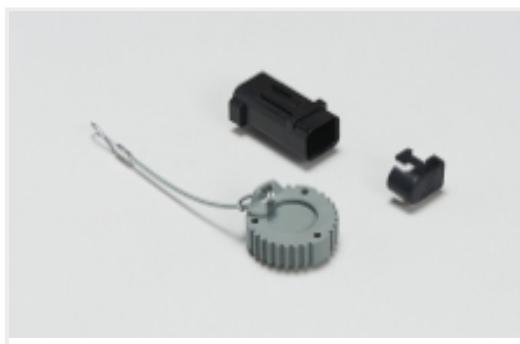

Automotive Connector Caps & Covers (1)

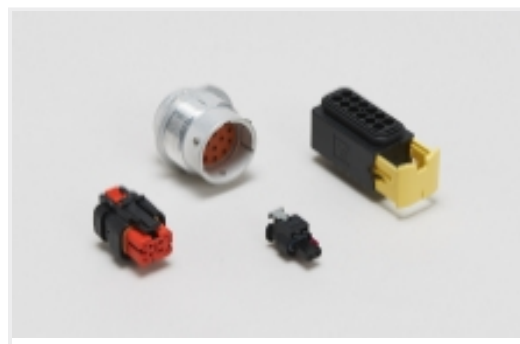

Automotive Housings(47)

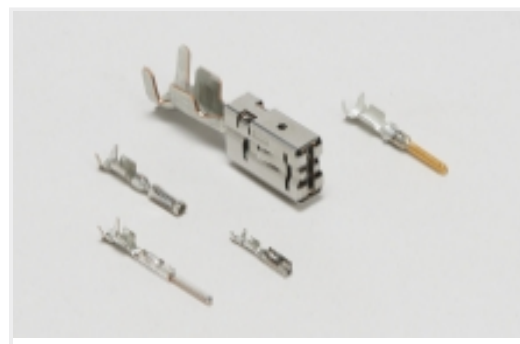

Automotive Terminals(25)



Connector Seals & Cavity Plugs(9)



Insertion & Extraction Tools(13)



Other Automotive Connector Accessories(1)

Customers Also Bought



TE Part #9097616016
LSTT-4.8-0-30MM

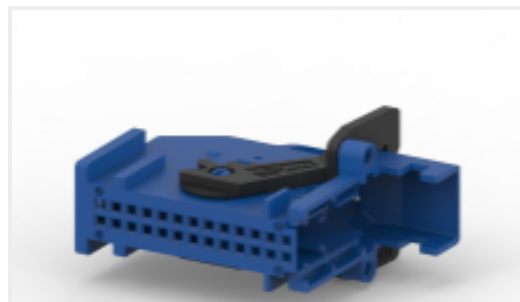

TE Part #1-185879-2
26W MQS COVER ASSY BLUE



TE Part #284225-2
24 POS.RCPT.CONN.HSG.FOR AIRBA



TE Part #1-2236343-5
3POS, MCON 1.2 LL REC SEALED



TE Part #1-1801175-1
2W RECEPTACLE HP CONNECTOR
BLACK



TE Part #953490-3
16W DIAG RCPT HSG ASSY

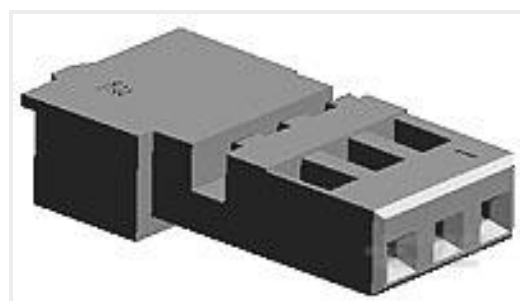

TE Part #185309-1
PLUG HOUSING 3W MQS



TE Part #1801178-1
3W RECEPTACLE HP CONNECTOR
BLACK



TE Part #1544141-1
CLIP8MM ECHANCRE S



TE Part #1544434-1
BOITIER PC 2 VOIES

Documents



Product Drawings

RECEPT HOUSING ASSY, 8MM, 2 W

English

CAD Files

Customer View Model

[ENG_CVM_CVM_1801422-3_B.2d_dxf.zip](#)

English

3D PDF

3D

Customer View Model

[ENG_CVM_CVM_1801422-3_B.3d_igs.zip](#)

English

Customer View Model

[ENG_CVM_CVM_1801422-3_B.3d_stp.zip](#)

English

By downloading the CAD file I accept and agree to the [Terms and Conditions](#) of use.

Product Specifications

Product Specification

English

Instruction Sheets

Instruction Sheet (non U.S.)

French

Instruction Sheet (non U.S.)

English