

170363-1 ✓ ACTIVE

MATE-N-LOK | Mini-Universal MATE-N-LOK

TE Internal #: 170363-1

Pin Contact, Tin, 600 VAC, 600 VDC, 26 – 22 AWG, .12 – .35 mm²

Wire, Crimp, Brass, Power, -20 – 105 °C [-4 – 221 °F], Mini-Universal

MATE-N-LOK

[View on TE.com >](#)



Connectors > Contacts > Connector Contacts

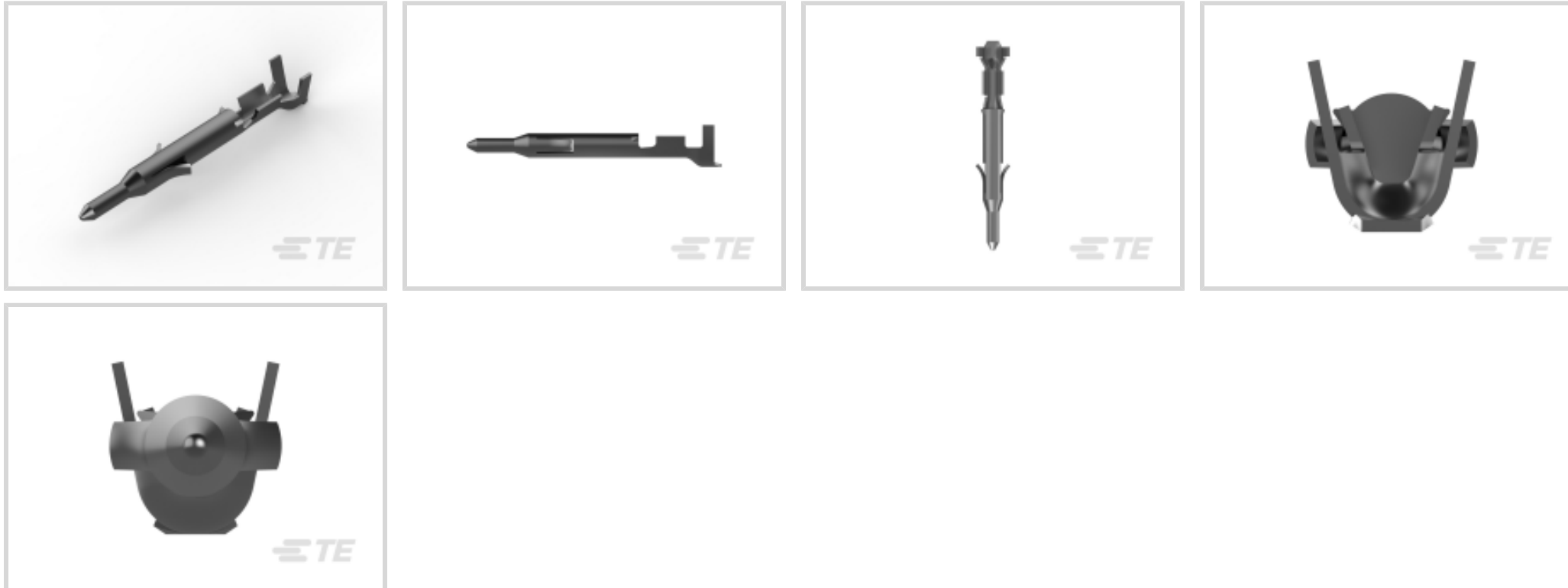

Contact Type: **Pin**

Contact Mating Area Plating Material: **Tin**

Wire Contact Termination Area Plating Material: **Pre-Tin**

Operating Voltage: **600 VDC**

Features

Industry Standards

Compatible With Agency/Standards Products	UL, CSA
---	---------

Product Type Features

Discrete Wire Type	Stranded
--------------------	----------

Mechanical Attachment

Wire Insulation Support	Without
-------------------------	---------

Packaging Features

Packaging Quantity	300
Packaging Method	Bag

Dimensions

Compatible Insulation Diameter Range	1.19 – 1.75 mm [.047 – .069 in]
Wire Size	.12 – .35 mm ²

Contact Features

Contact Orientation	Straight
Mating Pin Diameter	1 mm [.039 in]



Contact Mating Area Plating Material Thickness	.8 μm[31.49 μin]
Wire Contact Termination Area Plating Thickness	.8 μm[31.49 μin]
Barrel Type	Open
Contact Type	Pin
Contact Mating Area Plating Material	Tin
Wire Contact Termination Area Plating Material	Pre-Tin
Contact Retention Within Housing	With
Contact Base Material	Brass
Contact Current Rating (Max)	7 A

Electrical Characteristics

Operating Voltage	600 VDC
-------------------	---------

Termination Features

Termination Method to Wire & Cable	Crimp
Product Terminates To	Wire & Cable

Usage Conditions

Operating Temperature Range	-20 – 105 °C[-4 – 221 °F]
-----------------------------	---------------------------

Operation/Application

Circuit Application	Power
---------------------	-------

Product Compliance

[For compliance documentation, visit the product page on TE.com>](#)

EU RoHS Directive 2011/65/EU	Compliant
EU ELV Directive 2000/53/EC	Compliant
China RoHS 2 Directive MIIT Order No 32, 2016	No Restricted Materials Above Threshold
EU REACH Regulation (EC) No. 1907/2006	Current ECHA Candidate List: JUNE 2024 (241) Candidate List Declared Against: JUNE 2024 (241) Does not contain REACH SVHC
Halogen Content	Low Halogen - Br, Cl, F, I < 900 ppm per homogenous material. Also BFR/CFR/PVC Free
Solder Process Capability	Not applicable for solder process capability

Product Compliance Disclaimer

This information is provided based on reasonable inquiry of our suppliers and represents our current actual knowledge based on the information they provided. This information is subject to change. The part numbers that TE has identified as EU RoHS compliant have a maximum concentration of 0.1% by weight in homogenous materials for lead, hexavalent chromium, mercury, PBB, PBDE, DBP, BBP, DEHP, DIBP, and 0.01% for cadmium, or qualify for an exemption to these limits as defined in the Annexes of Directive 2011/65/EU (RoHS2). Finished electrical and electronic equipment products will be CE marked as required by Directive 2011/65/EU. Components may not be CE marked. Additionally, the part numbers that TE has identified as EU ELV compliant have a maximum concentration of 0.1% by weight in homogenous materials for lead, hexavalent chromium, and mercury, and 0.01% for cadmium, or qualify for an exemption to these limits as defined in the Annexes of Directive 2000/53/EC (ELV). Regarding the REACH Regulation, the information TE provides on SVHC in articles for this part number is based on the latest European Chemicals Agency (ECHA) 'Guidance on requirements for substances in articles' posted at this URL: <https://echa.europa.eu/guidance-documents/guidance-on-reach>

Compatible Parts

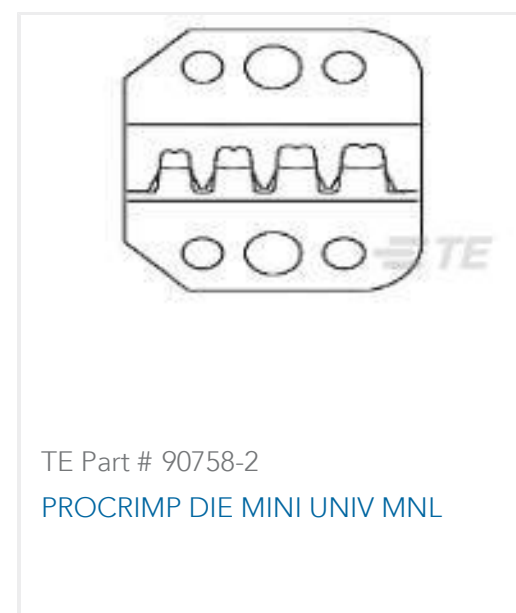



Also in the Series | Mini-Universal MATE-N-LOK

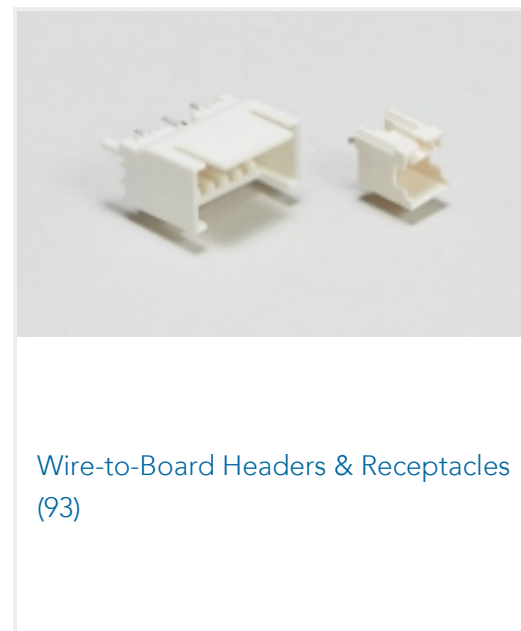
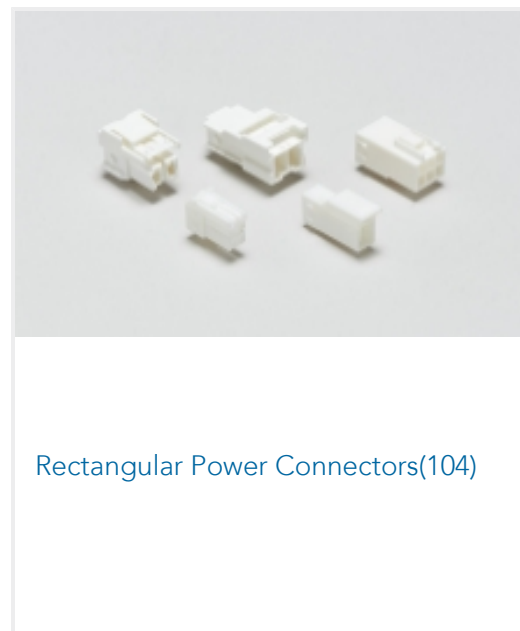
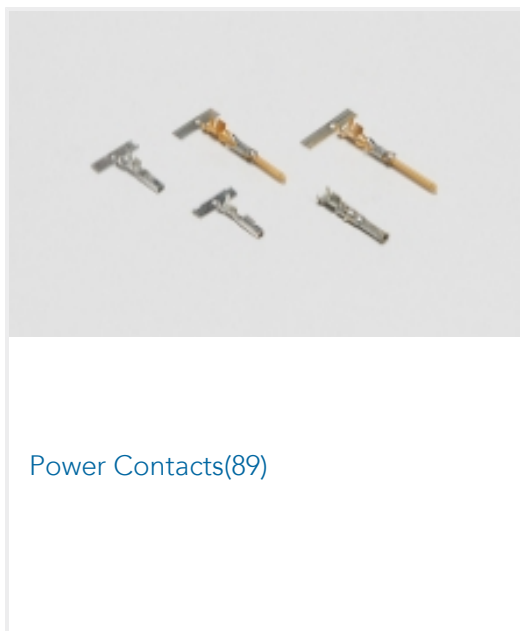
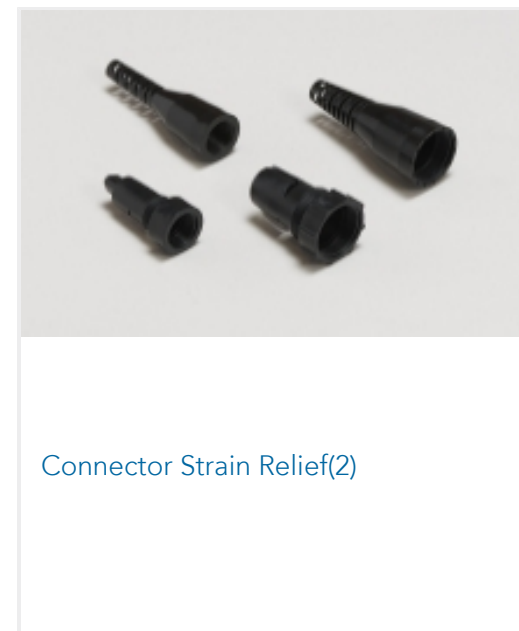
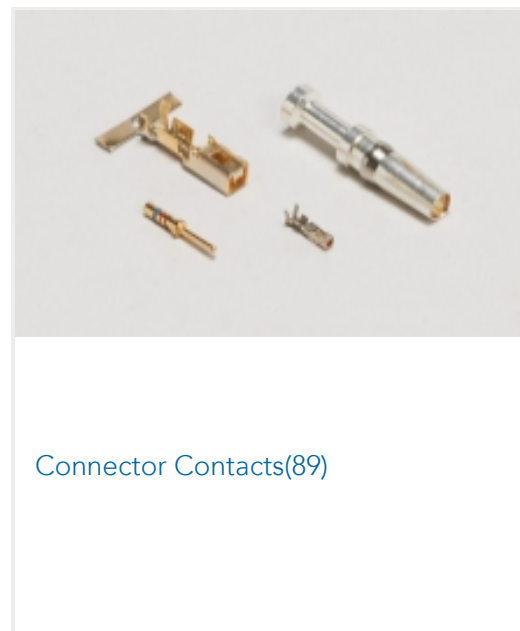
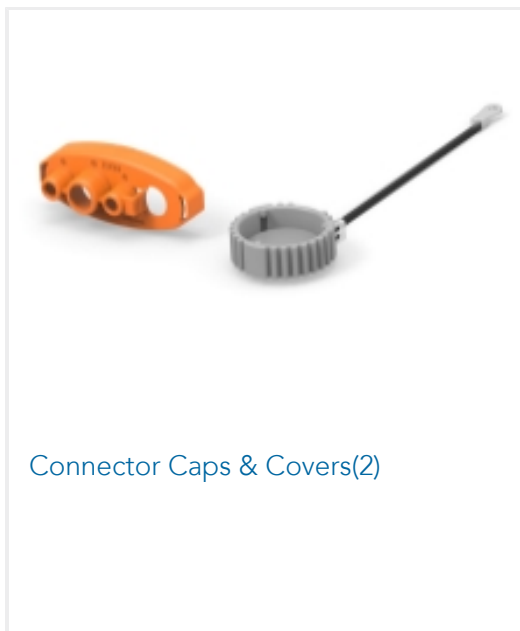

Customers Also Bought





Documents

Product Drawings

MINI UNIVERSAL M-N-L PIN LP

English

CAD Files

3D PDF

3D

Customer View Model

[ENG_CVM_CVM_170363-1_1_c-170363-1-1.2d_dxf.zip](#)

English

Customer View Model

[ENG_CVM_CVM_170363-1_1_c-170363-1-1.3d_igs.zip](#)

English

Customer View Model

[ENG_CVM_CVM_170363-1_1_c-170363-1-1.3d_stp.zip](#)

English

By downloading the CAD file I accept and agree to the [Terms and Conditions](#) of use.

Product Specifications

Crimping of Mini-Universal MATE-N-LOK Contact

Japanese

Application Specification

Japanese

Instruction Sheets

Instruction Sheet (non U.S.)

Japanese

Mini-Universal MATE-N-LOK Connector

Japanese

Agency Approvals

UL Report

English