

165017 ✓ ACTIVE



PLASTI-GRIP

TE Internal #: 165017

Spade Tongue Terminal, 12 – 10 AWG, M5 Stud, 5.2 mm [.205 in] Stud Diameter, Closed Barrel, Straight, Tin Plating, Partially Insulated, PLASTI-GRIP

[View on TE.com >](#)

Terminals & Splices > Spade Terminals



Spade Terminal Type: **Spade Tongue Terminal**

Wire Size: **5180 – 13100 CMA**

Stud Size: **M5**

Features

Mechanical Attachment

Wire Insulation Support	Without
-------------------------	---------

Electrical Characteristics

Voltage Rating	600 V
----------------	-------

Industry Standards

Government Qualified Terminal	No
-------------------------------	----

Body Features

Product Weight	2.289 g
Insulation Sleeve Color	Yellow
Stripe Color	Yellow

Packaging Features

Packaging Quantity	500
Packaging Method	Box

Product Type Features

Stud Size	M5
Sealable	No



Wire Insulation Support Retention Type	Insulation Support
--	--------------------

Contact Features

Spade Terminal Type	Spade Tongue Terminal
Barrel Type	Closed
Terminal Orientation	Straight
Terminal Plating Material	Tin

Dimensions

Wire Size	5180 – 13100 CMA
Stud Diameter	5.2 mm [.205 in]
Tongue Thickness	.79 mm [.031 in]
Product Length	33.07 mm [1.302 in]
Compatible Insulation Diameter (Max)	6.4 mm [.252 in]
Compatible Insulation Diameter Range	3.8 – 6.4 mm [.149 – .252 in]

Usage Conditions

Insulation Option	Partially Insulated
-------------------	---------------------

Operation/Application

Compatible With Wire Base Material	Copper
Compatible With Wire Plating Material	Tin

Other

EU RoHS Compliance	Compliant
EU ELV Compliance	Compliant

Product Compliance

[For compliance documentation, visit the product page on TE.com>](#)

EU RoHS Directive 2011/65/EU	Compliant
EU ELV Directive 2000/53/EC	Compliant
China RoHS 2 Directive MIIT Order No 32, 2016	No Restricted Materials Above Threshold
EU REACH Regulation (EC) No. 1907/2006	Current ECHA Candidate List: JUNE 2024 (241) Candidate List Declared Against: JUNE 2024 (241) Does not contain REACH SVHC
Halogen Content	Not Low Halogen - contains Br or Cl > 900 ppm.

Solder Process Capability

Not applicable for solder process capability

Product Compliance Disclaimer

This information is provided based on reasonable inquiry of our suppliers and represents our current actual knowledge based on the information they provided. This information is subject to change. The part numbers that TE has identified as EU RoHS compliant have a maximum concentration of 0.1% by weight in homogenous materials for lead, hexavalent chromium, mercury, PBB, PBDE, DBP, BBP, DEHP, DIBP, and 0.01% for cadmium, or qualify for an exemption to these limits as defined in the Annexes of Directive 2011/65/EU (RoHS2). Finished electrical and electronic equipment products will be CE marked as required by Directive 2011/65/EU. Components may not be CE marked. Additionally, the part numbers that TE has identified as EU ELV compliant have a maximum concentration of 0.1% by weight in homogenous materials for lead, hexavalent chromium, and mercury, and 0.01% for cadmium, or qualify for an exemption to these limits as defined in the Annexes of Directive 2000/53/EC (ELV). Regarding the REACH Regulation, the information TE provides on SVHC in articles for this part number is based on the latest European Chemicals Agency (ECHA) 'Guidance on requirements for substances in articles' posted at this URL: <https://echa.europa.eu/guidance-documents/guidance-on-reach>

Compatible Parts



Also in the Series | PLASTI-GRIP

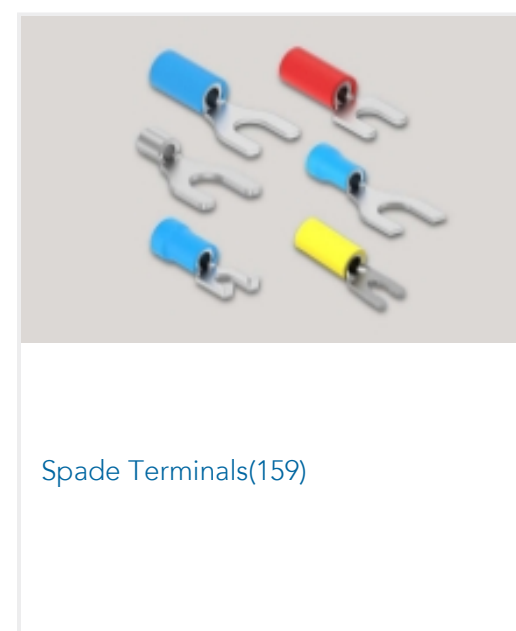
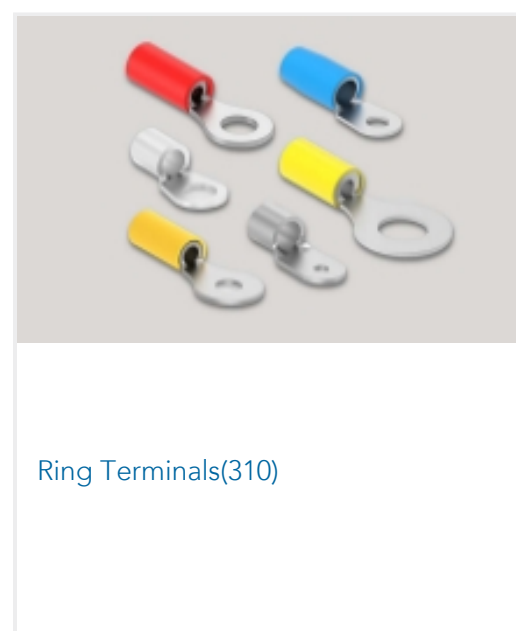
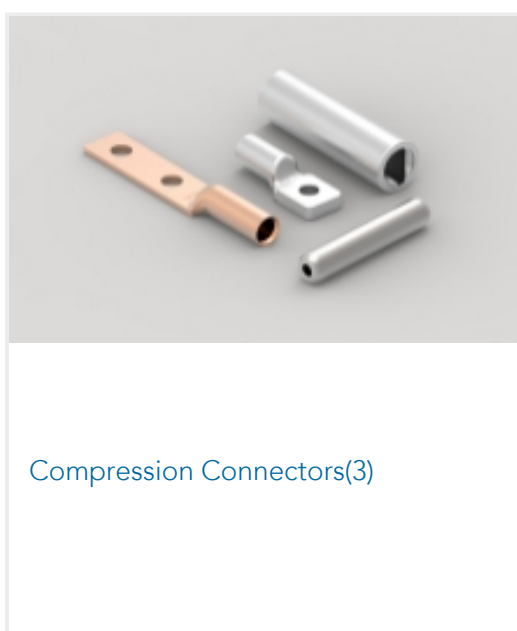

Customers Also Bought



TE Part #DT04-2P
REC, 2P, GRY, N



TE Part #DT06-2S
PLG, 2P, GRY, N



TE Part #CAT-D487-W416
Wedgelocks: DEUTSCH DT

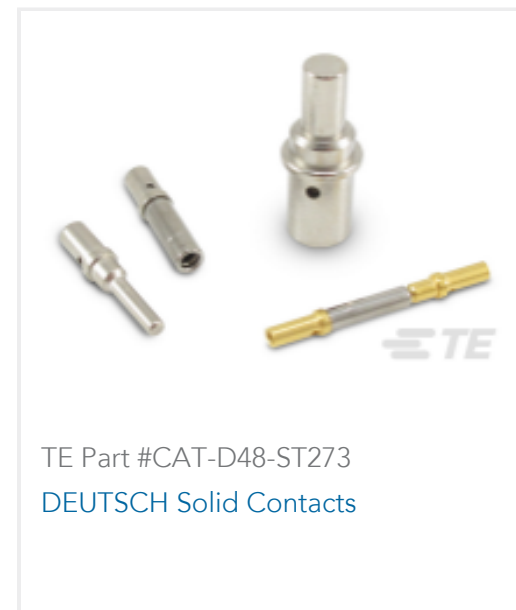

TE Part #CAT-D48-ST273
DEUTSCH Solid Contacts

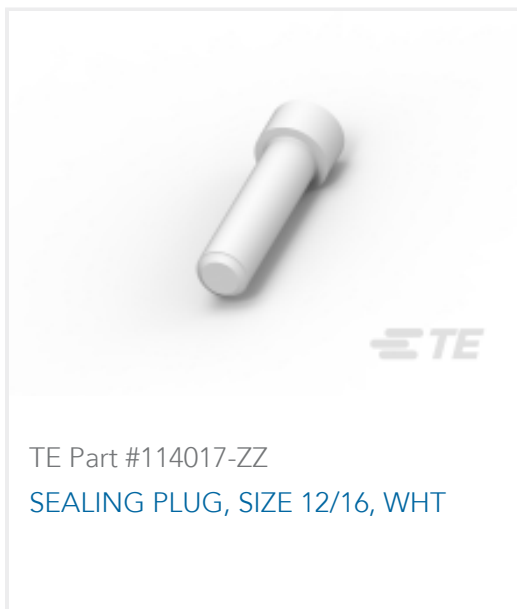

TE Part #114017-ZZ
SEALING PLUG, SIZE 12/16, WHT

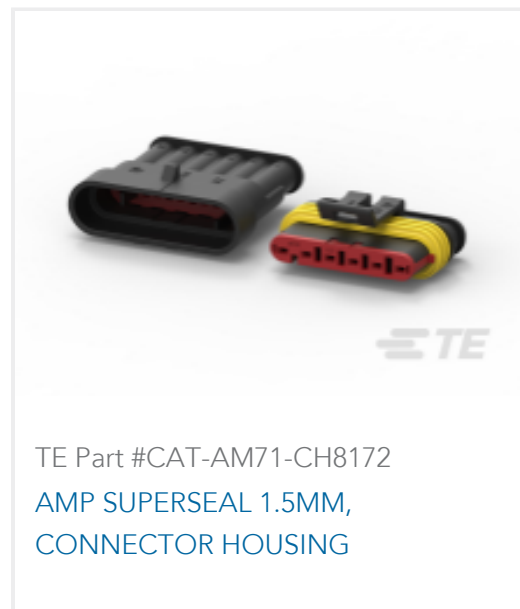

TE Part #CAT-AM71-CH8172
AMP SUPERSEAL 1.5MM,
CONNECTOR HOUSING

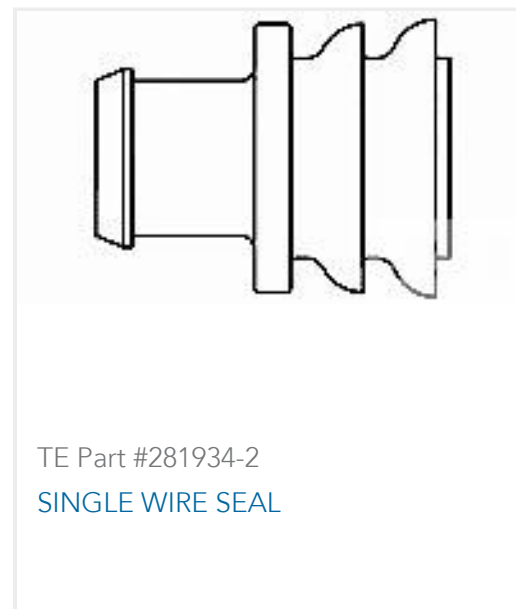

TE Part #281934-2
SINGLE WIRE SEAL

Documents

Product Drawings

[PLASTI-GRIP, SPADE 12-10 5MM](#)

English

CAD Files

[3D PDF](#)

3D

Customer View Model

[ENG_CVM_CVM_165017_L.2d_dxf.zip](#)

English

Customer View Model

[ENG_CVM_CVM_165017_L.3d_igs.zip](#)

English

Customer View Model

[ENG_CVM_CVM_165017_L.3d_stp.zip](#)

English

By downloading the CAD file I accept and agree to the [Terms and Conditions](#) of use.

Product Specifications

[Application Specification](#)

English

Instruction Sheets

[Instruction Sheet \(U.S.\)](#)

English

Agency Approvals

[UL Report](#)

165017

Spade Tongue Terminal, 12 – 10 AWG, M5 Stud, 5.2 mm [.205 in] Stud Diameter,
Closed Barrel, Straight, Tin Plating, Partially Insulated, PLASTI-GRIP



English