

160915-1 ✓ ACTIVE

FASTON | FASTON 250

TE Internal #: 160915-1

Quick Disconnect Receptacle, Uninsulated, 20 – 17 AWG, .5 – 1 mm<sup>2</sup> Wire, 6.35 mm [.25 in] Tab Width, Tab-Lok, Straight, Phosphor Bronze, FASTON 250

[View on TE.com >](#)



Terminals & Splices > Quick Disconnects

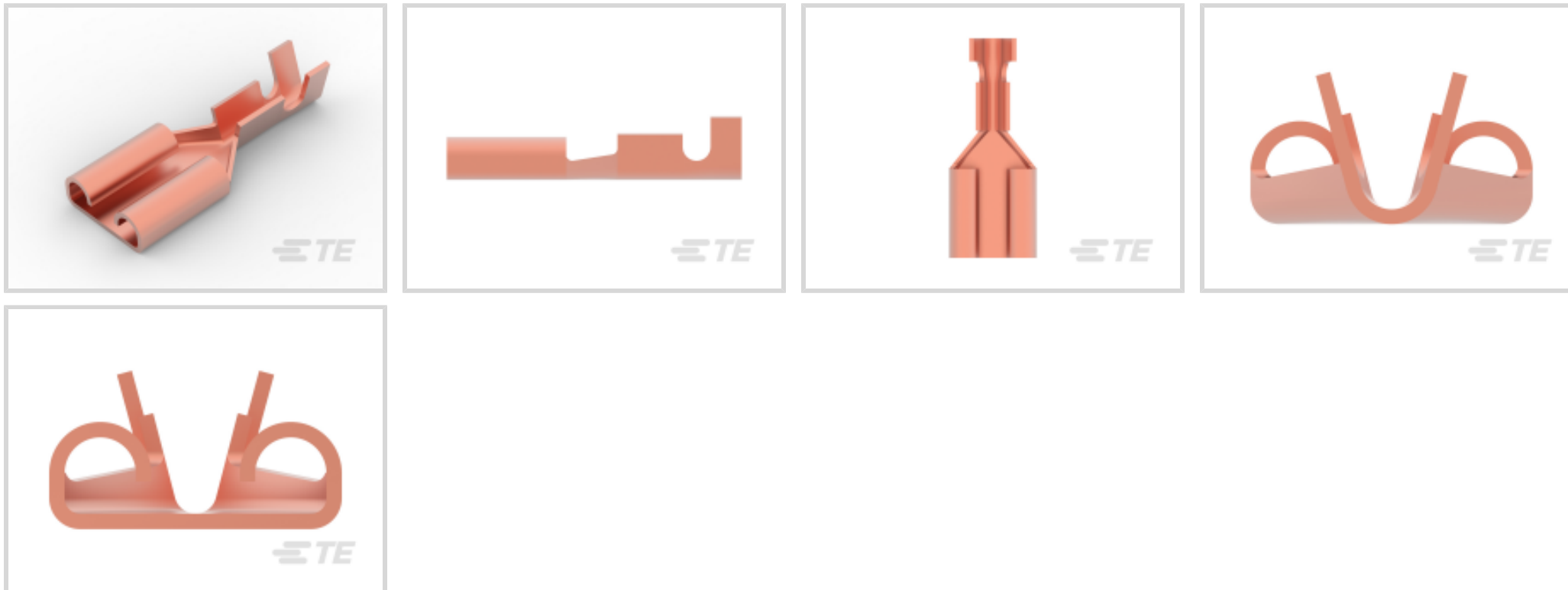

Quick Disconnect Terminal Type: **Receptacle**

Wire Size: .5 – 1 mm<sup>2</sup>

Mating Tab Width: 6.35 mm [.25 in]

Mating Tab Thickness: .81 mm [.032 in]

## Features

### Product Type Features

Insertion Force	Normal
-----------------	--------

### Configuration Features

Compatible With Wire & Cable Type	Discrete Wire
Connection Capacity	Single

### Contact Features

Quick Disconnect Terminal Type	Receptacle
Mating Tab Width	6.35 mm [.25 in]
Mating Tab Thickness	.81 mm [.032 in]
Terminal Orientation	Straight
Contact Base Material	Phosphor Bronze
Terminal Plating Material	Unplated
Crimp Type	Tab-Lok
Barrel Type	Open

### Termination Features

--	--



Product Terminates To	Wire & Cable
-----------------------	--------------

### Mechanical Attachment

Wire Insulation Support	With
Mating Retention Type	Dimple

### Dimensions

Product Length	19 mm[.748 in]
Compatible Insulation Diameter Range	1.4 – 2.31 mm[.055 – .091 in]
Terminal Material Thickness	.41 mm[.016 in]
Wire Size	.5 – 1 mm <sup>2</sup>

### Usage Conditions

Insulation Option	Uninsulated
Operating Temperature Range	-40 – 110 °C[-40 – 230 °F]

### Packaging Features

Packaging Quantity	5000
Packaging Method	Strip/Reel

### Other

Line	Premier
------	---------

## Product Compliance

[For compliance documentation, visit the product page on TE.com>](#)

EU RoHS Directive 2011/65/EU	Compliant
EU ELV Directive 2000/53/EC	Compliant
China RoHS 2 Directive MIIT Order No 32, 2016	有害物质含量符合标准要求 No Restricted Substance(s) Above Threshold
EU REACH Regulation (EC) No. 1907/2006	Current ECHA Candidate List: JUNE 2025 (250) Candidate List Declared Against: JUNE 2025 (250) Does not contain REACH SVHC
Halogen Content	Low Halogen - Br, Cl, F < 900 ppm per homogenous material. Also BFR/CFR/PVC Free
Solder Process Capability	Not applicable for solder process capability

Product Compliance Disclaimer



This information is provided based on reasonable inquiry of our suppliers and represents our current actual knowledge based on the information they provided. This information is subject to change. The part numbers that TE has identified as EU RoHS compliant have a maximum concentration of 0.1% by weight in homogenous materials for lead, hexavalent chromium, mercury, PBB, PBDE, DBP, BBP, DEHP, DIBP, and 0.01% for cadmium, or qualify for an exemption to these limits as defined in the Annexes of Directive 2011/65/EU (RoHS2). Finished electrical and electronic equipment products will be CE marked as required by Directive 2011/65/EU. Components may not be CE marked. Additionally, the part numbers that TE has identified as EU ELV compliant have a maximum concentration of 0.1% by weight in homogenous materials for lead, hexavalent chromium, and mercury, and 0.01% for cadmium, or qualify for an exemption to these limits as defined in the Annexes of Directive 2000/53/EC (ELV). Regarding the REACH Regulation, the information TE provides on SVHC in articles for this part number is based on the latest European Chemicals Agency (ECHA) 'Guidance on requirements for substances in articles' posted at this URL: <https://echa.europa.eu/guidance-documents/guidance-on-reach>

## Compatible Parts

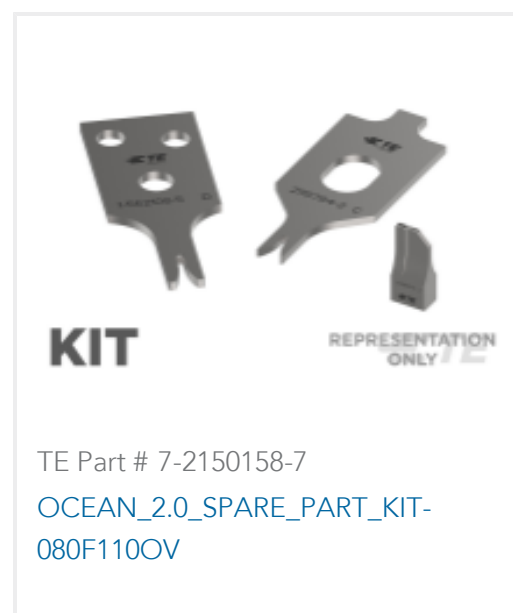

## Also in the Series | FASTON 250

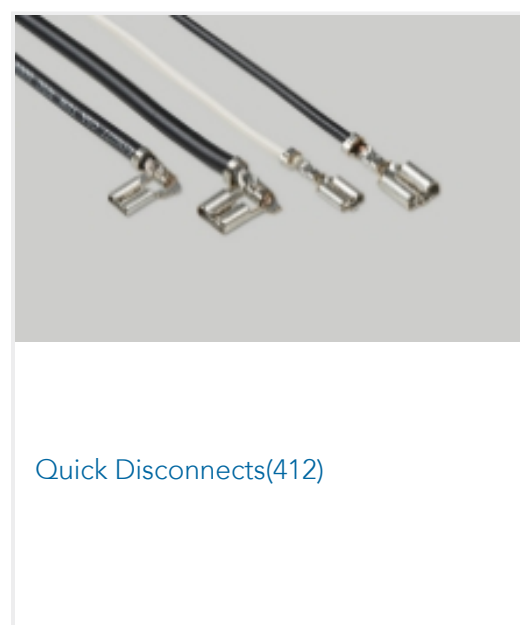
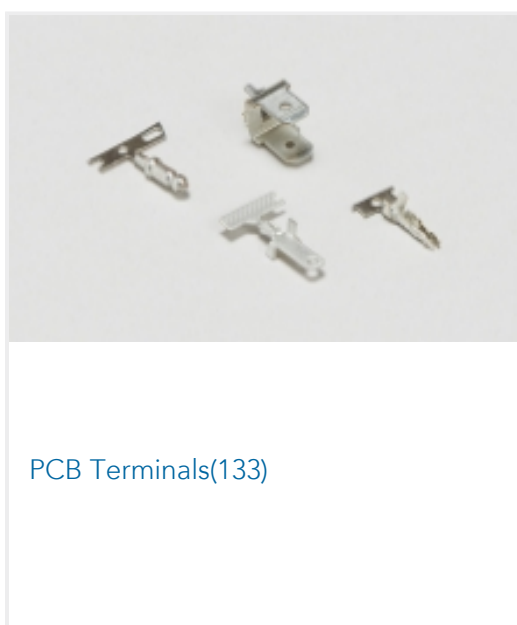
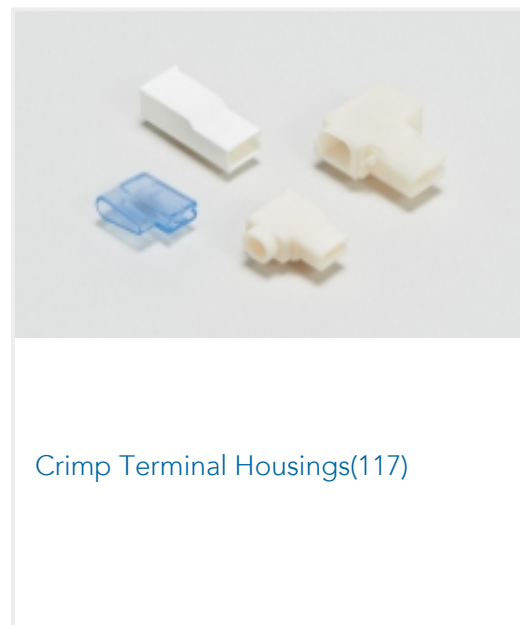
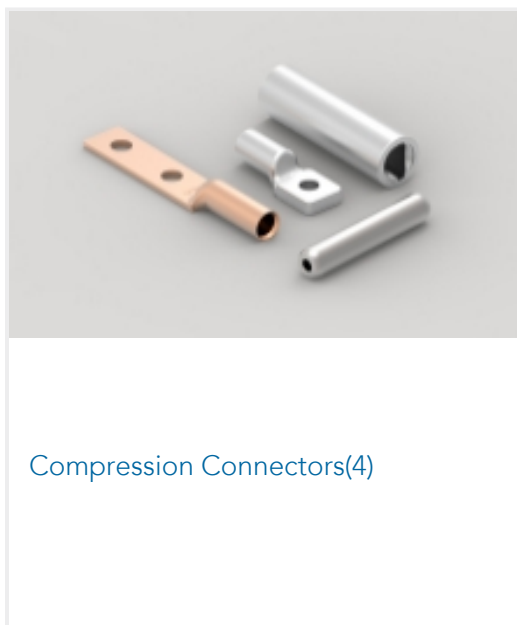

## Customers Also Bought

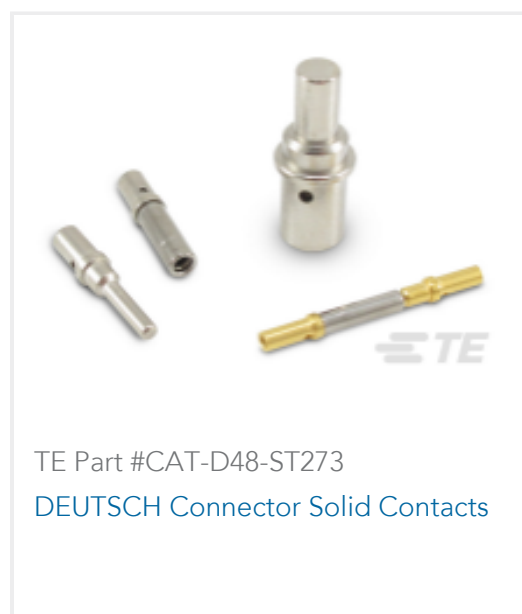

TE Part #CAT-D48-ST273  
DEUTSCH Connector Solid Contacts



TE Part #DT04-2P  
REC, 2P, GRY, N



TE Part #CAT-D487-W416  
Wedgelocks: DEUTSCH DT



TE Part #DT06-2S  
PLG, 2P, GRY, N



TE Part #114017-ZZ  
SEALING PLUG, SIZE 12/16, WHT

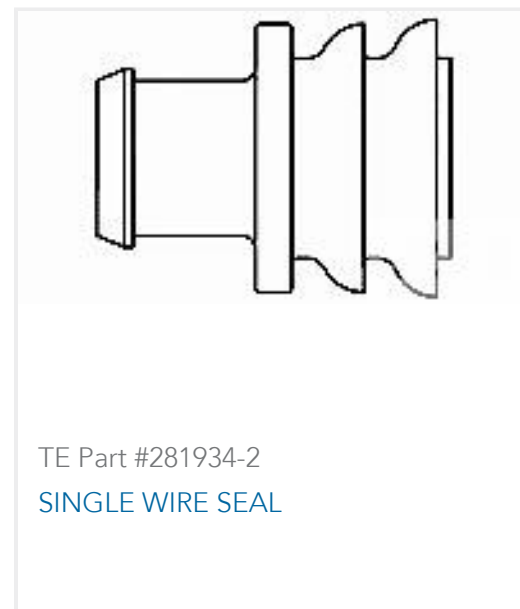

TE Part #281934-2  
SINGLE WIRE SEAL



TE Part #CAT-AM71-CH8172  
AMP SUPERSEAL 1.5MM,  
CONNECTOR HOUSING

## Documents

### Product Drawings

250 FASTON,REC.,20-17 AWG,PB

English

### CAD Files

Customer View Model

[ENG\\_CVM\\_CVM\\_160915-1\\_H.2d\\_dxf.zip](#)

English

### 3D PDF

3D

Customer View Model

[ENG\\_CVM\\_CVM\\_160915-1\\_H.3d\\_igs.zip](#)

English

Customer View Model

[ENG\\_CVM\\_CVM\\_160915-1\\_H.3d\\_stp.zip](#)

English

By downloading the CAD file I accept and agree to the [Terms and Conditions](#) of use.

### Product Specifications

[Application Specification](#)

English