



**SIAMEZE**

TE Internal #: 1601028-1

Tab, 6.35 mm [.25 in] Tab Width, .16 – 1.02 mm Magnet Wire, 34 – 18 AWG Magnet Wire, Insulation Displacement (IDC), SIAMEZE, Magnet Wire Terminals

[View on TE.com >](#)

Terminals & Splices > Magnet Wire Terminals

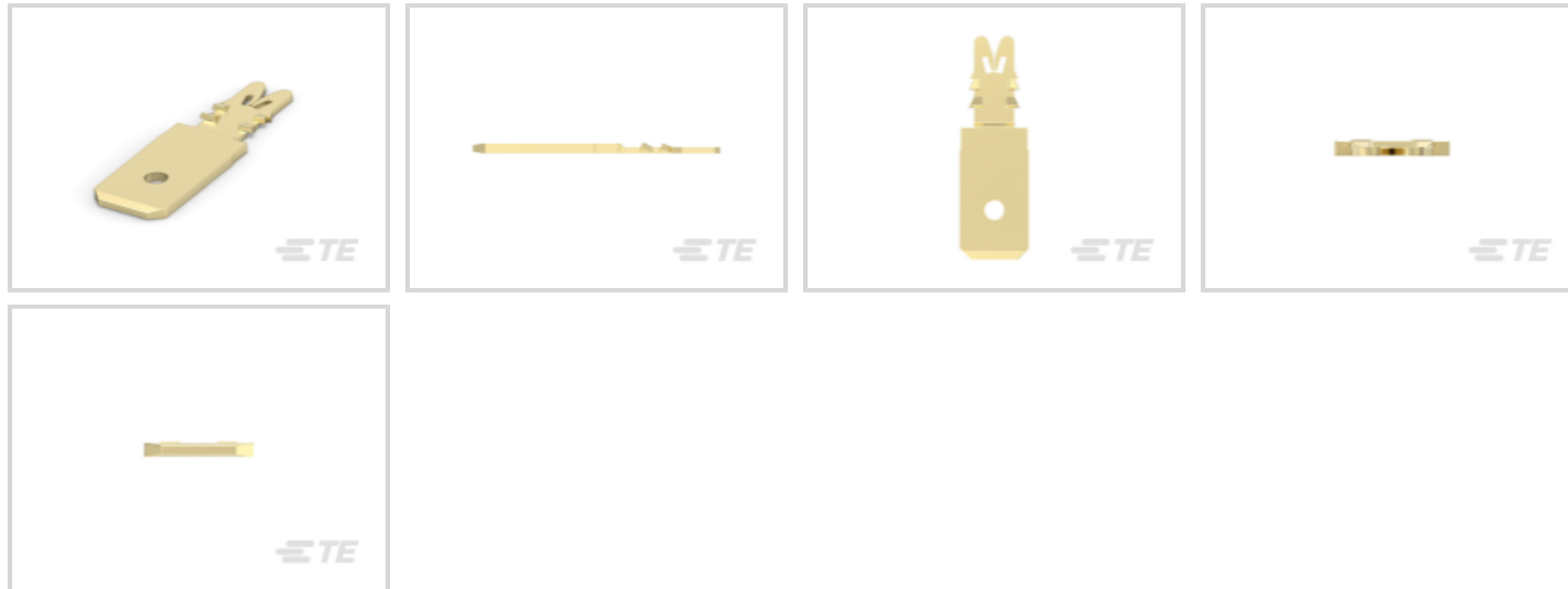

Magnet Wire Terminal Type: **Tab**

Mating Tab Width: **6.35 mm [.25 in]**

Mating Tab Thickness: **.81 mm [.032 in]**

Magnet Wire Size: **.16 – 1.02 mm**

**Features**

**Usage Conditions**

Insulation Option	Uninsulated
-------------------	-------------

**Packaging Features**

Packaging Quantity	20000
Packaging Method	Reel

**Dimensions**

Terminal Height	8.38 mm[.33 in]
Magnet Wire Size	.16 – 1.02 mm
Stock Thickness (Magnet Wire Side)	.81 mm[.032 in]
Product Length	20.45 mm[.805 in]

**Product Type Features**

Compatible With Discrete Wire Type	Solid, Magnet Wire
------------------------------------	--------------------

**Contact Features**

Magnet Wire Terminal Type	Tab
Mating Tab Width	6.35 mm[.25 in]



Mating Tab Thickness	.81 mm[.032 in]
Terminal Plating Material	Unplated
Terminal Orientation	Straight

#### Termination Features

Termination Method to Wire & Cable	Insulation Displacement (IDC)
------------------------------------	-------------------------------

#### Mechanical Attachment

Mating Retention Type	Hole, Barbs
-----------------------	-------------

#### Operation/Application

Compatible With Wire Base Material	Copper
------------------------------------	--------

#### Other

EU RoHS Compliance	Compliant
EU ELV Compliance	Compliant

### Product Compliance

[For compliance documentation, visit the product page on TE.com>](#)

EU RoHS Directive 2011/65/EU	Compliant
EU ELV Directive 2000/53/EC	Compliant
China RoHS 2 Directive MIIT Order No 32, 2016	No Restricted Materials Above Threshold
EU REACH Regulation (EC) No. 1907/2006	Current ECHA Candidate List: JUNE 2024 (241) Candidate List Declared Against: JUNE 2024 (241) Does not contain REACH SVHC
Halogen Content	Low Halogen - Br, Cl, F, I < 900 ppm per homogenous material. Also BFR/CFR/PVC Free
Solder Process Capability	Not applicable for solder process capability

#### Product Compliance Disclaimer

This information is provided based on reasonable inquiry of our suppliers and represents our current actual knowledge based on the information they provided. This information is subject to change. The part numbers that TE has identified as EU RoHS compliant have a maximum concentration of 0.1% by weight in homogenous materials for lead, hexavalent chromium, mercury, PBB, PBDE, DBP, BBP, DEHP, DIBP, and 0.01% for cadmium, or qualify for an exemption to these limits as defined in the Annexes of Directive 2011/65/EU (RoHS2). Finished electrical and electronic equipment products will be CE marked as required by Directive 2011/65/EU. Components may not be CE marked. Additionally, the part numbers that TE has identified as EU ELV compliant have a maximum concentration of 0.1% by weight in homogenous materials for lead, hexavalent chromium, and mercury, and 0.01% for cadmium, or qualify for an exemption to these limits as defined in the Annexes of Directive 2000/53/EC (ELV). Regarding the REACH Regulation, the information TE provides on SVHC in articles for this part number is based on the latest European Chemicals Agency (ECHA) 'Guidance on requirements for substances in articles' posted at this URL: <https://echa.europa.eu/guidance-documents/guidance-on-reach>

## Compatible Parts



TE Part # 2-1601003-1  
131-005-000=TAB,250X032,STDSMZ



TE Part # 1601425  
531-007-000=POCKET SPECIFICATION



TE Part # 1601115-1  
132-009-000=TAB,250X032,HD,SMZ



TE Part # 4-1601115-1  
032-009-000=TAB,250X032,HD,SMZ



TE Part # 3-1601061-2  
TAB,250X032,STD,SMZ



TE Part # 2-1601139-2  
TAB,250 X 032,MED,SMZ

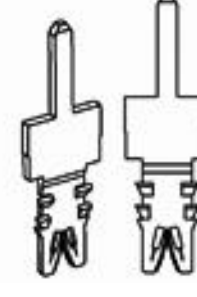

TE Part # 293214-1  
1.5 SIAMEZE TAB CTC. FOR RAST 2,5 APPL.



TE Part # 2-284937-1  
TAB SIAMEZE CONTACT .250" x.03



TE Part # 1-1601061-2  
TAB,250X032,STD,SMZ

## Also in the Series | SIAMEZE



Insertion & Extraction Tools(1)



Magnet Wire Terminals(191)

## Customers Also Bought

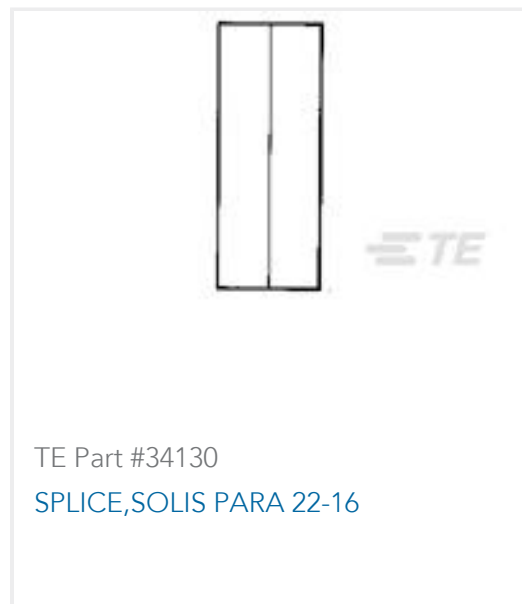
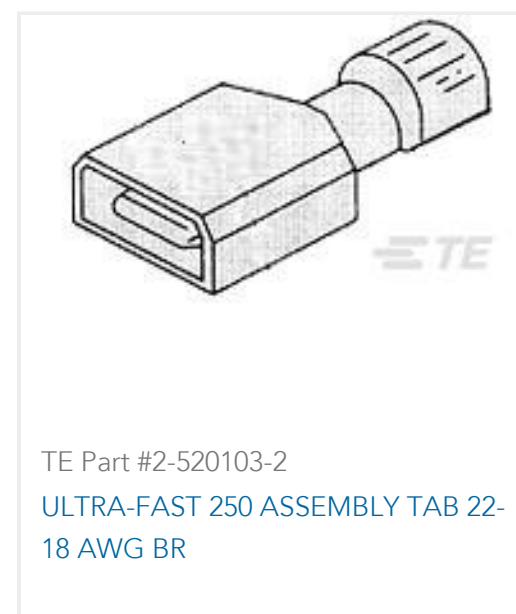
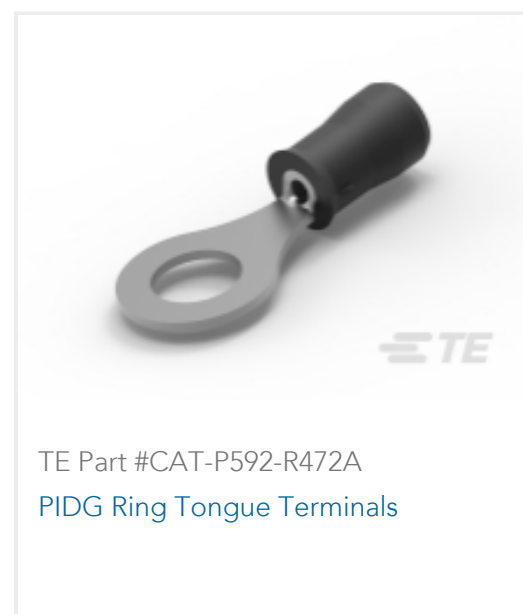

## Documents

### Product Drawings

[131-064-000=TAB,250X032,STDSMZ](#)

English

[131-064-000=TAB,250X032,STDSMZ](#)

English

### CAD Files

[3D PDF](#)

3D

Customer View Model

[ENG\\_CVM\\_CVM\\_1601028-1\\_E\\_c-1601028-1-e.2d\\_dxf.zip](#)

English

Customer View Model

[ENG\\_CVM\\_CVM\\_1601028-1\\_E\\_c-1601028-1-e.3d\\_igs.zip](#)

English

Customer View Model

[ENG\\_CVM\\_CVM\\_1601028-1\\_E\\_c-1601028-1-e.3d\\_stp.zip](#)

English

By downloading the CAD file I accept and agree to the [Terms and Conditions](#) of use.

### Datasheets & Catalog Pages

[1654742\\_HOUSEHOLD\\_APPLIANCES\\_RAST5](#)

English

### Magnet Wire Terminals & Splices

English

[1-1773702-7\\_IDC\\_Magnet\\_Wire](#)

English



---

[Product Specifications](#)

[Application Specification](#)

English