

Nanonics

TE Internal #: 1589481-8

Plug, Wire-to-Board, 65 Position, 1.27 mm [.05 in] Centerline, Printed Circuit Board, Power, Board Mount, Microminiature & Nanominiature D Connectors

[View on TE.com >](#)



Connectors > D-Shaped Connectors > Microminiature & Nanominiature D Connectors > DUALOBE Plug Connectors: Metal Shell, 65 Pin/2 row

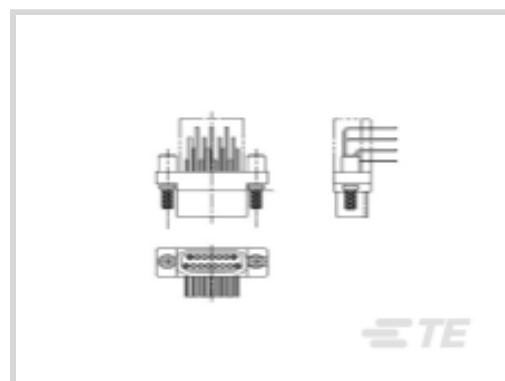

Connector & Housing Type: **Plug**

Connector System: **Wire-to-Board**

Number of Positions: **65**

Centerline (Pitch): **1.27 mm [.05 in]**

Sealable: **No**

[All DUALOBE Plug Connectors: Metal Shell, 65 Pin/2 row \(9\)](#)

Features

Termination Features

Termination Method to PCB	Through Hole - Solder
Termination Method to Wire & Cable	Preterminated Flying Leads

Contact Features

Contact Type	Pin
Contact Options	Installed
Contact Current Rating (Max)	1 A

Product Type Features

Connector & Housing Type	Plug
Connector System	Wire-to-Board
Sealable	No
Connector & Contact Terminates To	Printed Circuit Board

Configuration Features

Number of Positions	65
---------------------	----

Mechanical Attachment

Connector Mounting Type	Board Mount
-------------------------	-------------

Housing Features

Centerline (Pitch)	1.27 mm [.05 in]
--------------------	------------------

Usage Conditions

Operating Temperature Range	-200 – 200 °C [-328 – 392 °F]
-----------------------------	-------------------------------

Operation/Application

Circuit Application	Power
---------------------	-------

Other

EU RoHS Compliance	Not Compliant
--------------------	---------------

EU ELV Compliance	Not Compliant
-------------------	---------------

Product Compliance

[For compliance documentation, visit the product page on TE.com>](#)

EU RoHS Directive 2011/65/EU	Not Compliant
------------------------------	---------------

EU ELV Directive 2000/53/EC	Not Compliant
-----------------------------	---------------

China RoHS 2 Directive MIIT Order No 32, 2016	Restricted Materials Above Threshold
---	--------------------------------------

EU REACH Regulation (EC) No. 1907/2006	Current ECHA Candidate List: JUNE 2024 (241) Candidate List Declared Against: JAN 2022 (223) SVHC > Threshold: Pb (.4% in Plating)
--	---

Article Safe Usage Statements:

Do not eat, drink or smoke when using this product. Wash thoroughly after handling. Recycle if possible and dispose of the article by following all applicable governmental regulations relevant to your geographic location.

Halogen Content	Not Yet Reviewed for halogen content
-----------------	--------------------------------------

Solder Process Capability	Not lead free process capable
---------------------------	-------------------------------

Product Compliance Disclaimer

This information is provided based on reasonable inquiry of our suppliers and represents our current actual knowledge based on the information they provided. This information is subject to change. The part numbers that TE has identified as EU RoHS compliant have a maximum concentration of 0.1% by weight in homogenous materials for lead, hexavalent chromium, mercury, PBB, PBDE, DBP, BBP, DEHP, DIBP, and 0.01% for cadmium, or qualify for an exemption to these limits as defined in the Annexes of Directive 2011/65/EU (RoHS2). Finished electrical and electronic equipment products will be CE marked as required by Directive 2011/65/EU. Components may not be CE marked. Additionally, the part numbers that TE has identified as EU ELV compliant have a maximum concentration of 0.1% by weight in homogenous materials for lead, hexavalent chromium, and mercury, and 0.01% for cadmium, or qualify for an exemption to these limits as defined in the Annexes of Directive 2000/53/EC (ELV). Regarding the REACH Regulation, the information TE provides on SVHC in articles for this part number is based on the latest European Chemicals Agency (ECHA) 'Guidance on requirements for substances in articles' posted at this URL: <https://echa.europa.eu/guidance-documents/guidance-on-reach>

Compatible Parts

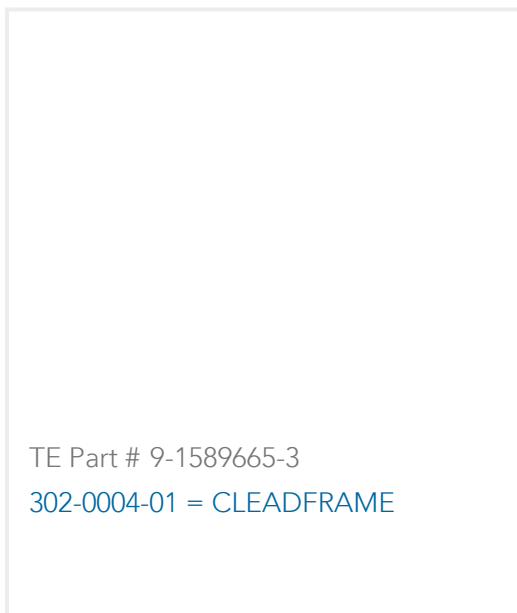

Customers Also Bought

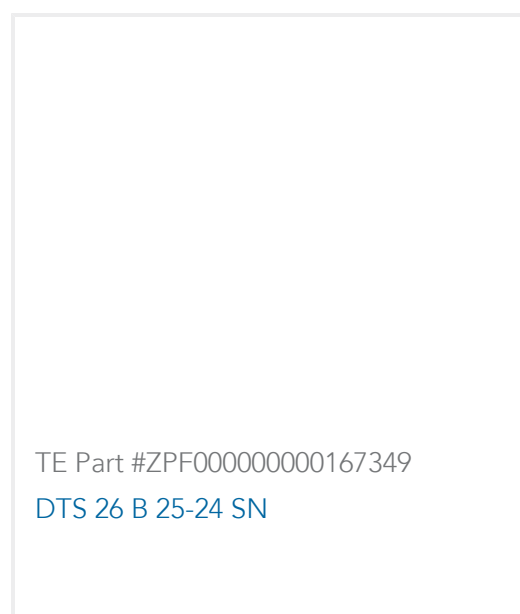
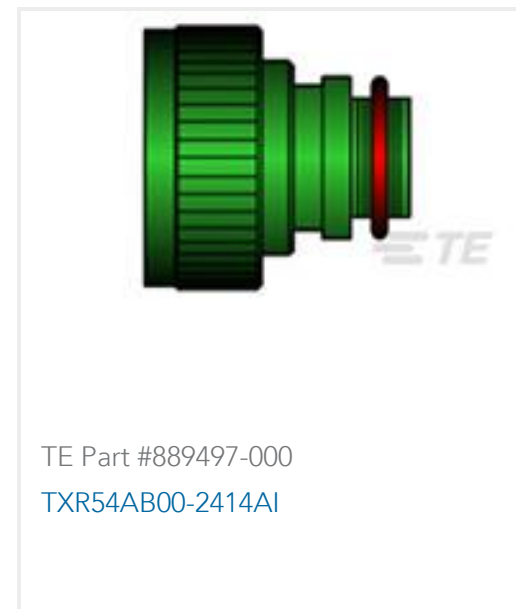
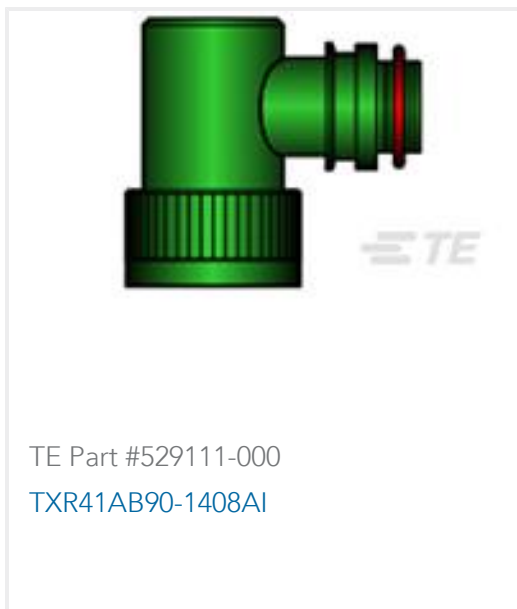
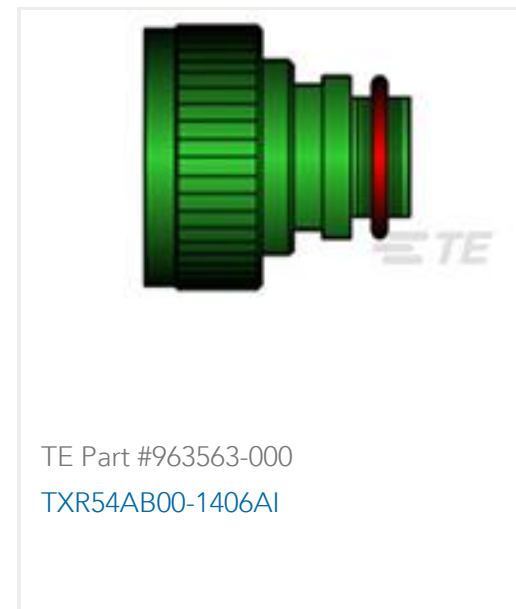
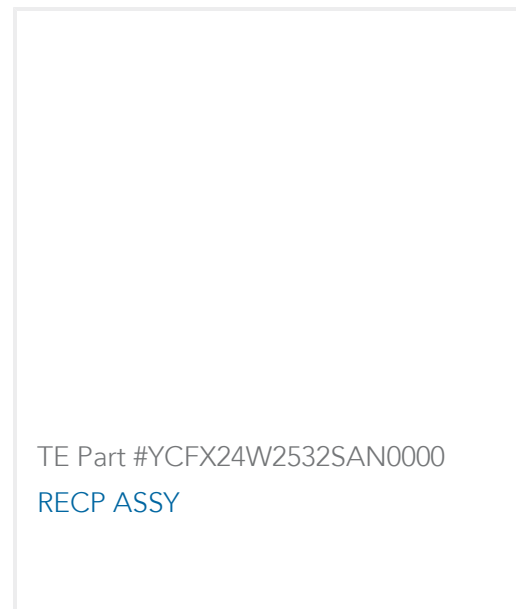
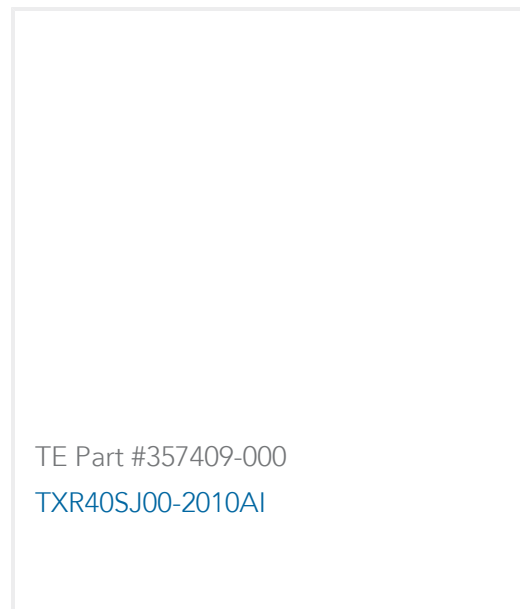

Documents

Product Drawings

[STM065C6N = THRU-HOLE](#)

English

CAD Files

[Customer View Model](#)

[ENG_CVM_CVM_1589481-8_U.2d_dxf.zip](#)

English

[3D PDF](#)



3D

Customer View Model

[ENG_CVM_CVM_1589481-8_U.3d_igs.zip](#)

English

Customer View Model

[ENG_CVM_CVM_1589481-8_U.3d_stp.zip](#)

English

By downloading the CAD file I accept and agree to the [Terms and Conditions](#) of use.

Datasheets & Catalog Pages

[1589481 Nanonics Cross Reference](#)

English