

1577633-1 ✓ ACTIVE



STRATO-THERM

TE Internal #: 1577633-1

Closed Ring Tongue Terminal, 18 – 16 AWG, #10 Stud, 5 mm [.197 in] Stud Diameter, Closed Barrel, Straight, Nickel Plating, STRATO-THERM

[View on TE.com >](#)

Terminals & Splices > Ring Terminals

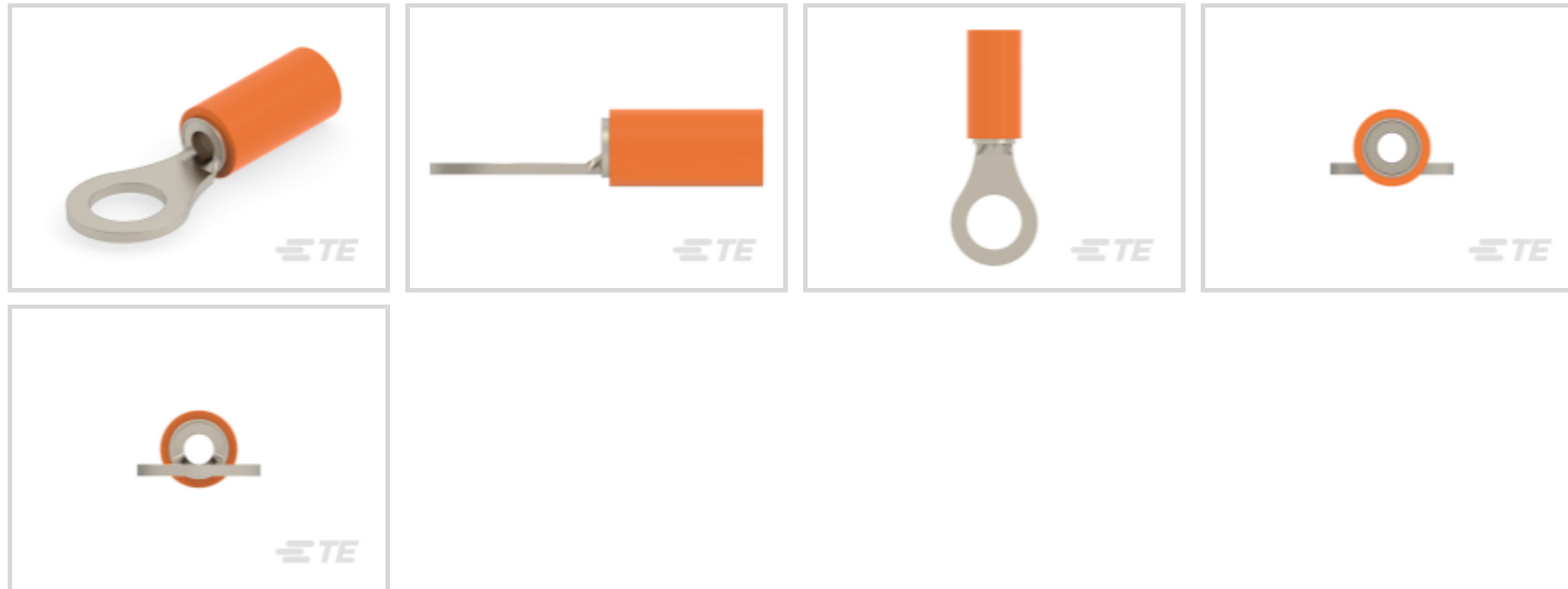

Ring Terminal Product Type: Closed Ring Tongue Terminal

Wire Size: 1600 – 2800 CMA

Stud Size: #10

Features

Mechanical Attachment

Wire Insulation Support	Without
-------------------------	---------

Industry Standards

Government Qualified Terminal	No
-------------------------------	----

Packaging Features

Packaging Quantity	500
--------------------	-----

Packaging Method	Bag/Box
------------------	---------

Product Type Features

Ring Terminal Product Type	Closed Ring Tongue Terminal
----------------------------	-----------------------------

Stud Size	#10
-----------	-----

Sealable	No
----------	----

Wire Insulation Support Retention Type	Non-Insulation Support
--	------------------------

Contact Features

Barrel Type	Closed
-------------	--------

Terminal Orientation	Straight
----------------------	----------

Terminal Plating Material	Nickel
---------------------------	--------



Dimensions

Wire Size	1600 – 2800 CMA
Stud Diameter	5 mm [.197 in]
Tongue Thickness	.79 mm [.031 in]
Product Length	22.43 mm [.883 in]
Compatible Insulation Diameter (Max)	2.67 mm [.106 in]
Compatible Insulation Diameter Range	1.4 – 2.67 mm [.055 – .106 in]

Usage Conditions

Insulation Option	Partially Insulated
-------------------	---------------------

Other

EU RoHS Compliance	Compliant
EU ELV Compliance	Compliant

Product Compliance

[For compliance documentation, visit the product page on TE.com>](#)

EU RoHS Directive 2011/65/EU	Compliant
EU ELV Directive 2000/53/EC	Compliant
China RoHS 2 Directive MIIT Order No 32, 2016	No Restricted Materials Above Threshold
EU REACH Regulation (EC) No. 1907/2006	Current ECHA Candidate List: JUNE 2024 (241) Candidate List Declared Against: JAN 2024 (240) Does not contain REACH SVHC
Halogen Content	Low Halogen - Br, Cl, F, I < 900 ppm per homogenous material. Also BFR/CFR/PVC Free
Solder Process Capability	Not applicable for solder process capability

Product Compliance Disclaimer

This information is provided based on reasonable inquiry of our suppliers and represents our current actual knowledge based on the information they provided. This information is subject to change. The part numbers that TE has identified as EU RoHS compliant have a maximum concentration of 0.1% by weight in homogenous materials for lead, hexavalent chromium, mercury, PBB, PBDE, DBP, BBP, DEHP, DIBP, and 0.01% for cadmium, or qualify for an exemption to these limits as defined in the Annexes of Directive 2011/65/EU (RoHS2). Finished electrical and electronic equipment products will be CE marked as required by Directive 2011/65/EU. Components may not be CE marked. Additionally, the part numbers that TE has identified as EU ELV compliant have a maximum concentration of 0.1% by weight in homogenous materials for lead, hexavalent chromium, and mercury, and 0.01% for cadmium, or qualify for an exemption to these limits as defined in the Annexes of Directive 2000/53/EC (ELV). Regarding the REACH Regulation, the information TE provides on SVHC in articles for this part number is based on the latest European Chemicals Agency (ECHA) 'Guidance on requirements for substances in articles' posted at this URL: <https://echa.europa.eu/guidance-documents/guidance-on-reach>

Compatible Parts



TE Part # 1-1901600-1
CCII 18-16 HEAD



TE Part # 1901600-2
CCII PIDG STRATO 18-16 ASSY

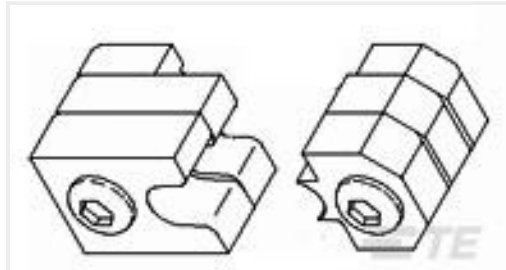

TE Part # 576714
SAHT PIDG PEEK STRATO 16 DIE SET



TE Part # 1901600-1
CCII PIDG STRATO 18-16 ASSY



TE Part # 576781
HHHT PIDG PEEK STRATO 16 ASSY



TE Part # 576780
HHHT PIDG PEEK STRATO 18 ASSY

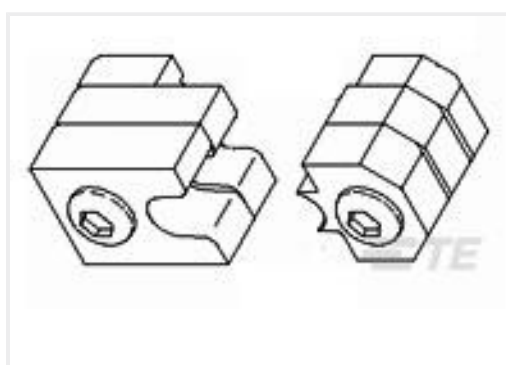

TE Part # 576715
SAHT PIDG PEEK STRATO 18 DIE SET

Also in the Series | STRATO-THERM



Crimp Wire Pins, Tabs & Ferrules(1)



Ring Terminals(85)



Splices(13)

Customers Also Bought

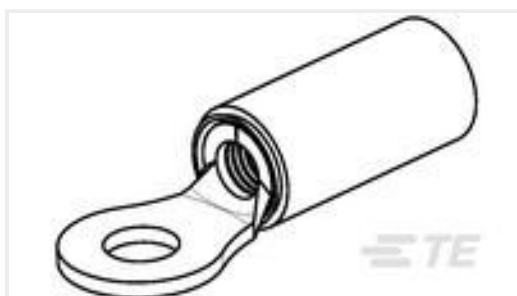

TE Part #1577646-1
TERMINAL RT PIDG PEEK STRATO 10 AWG



TE Part #1577632-1
TERMINAL RT PIDG PEEK STRATO 18-16 AWG



TE Part #1577648-1
TERMINAL RT PIDG PEEK STRATO 10 AWG



TE Part #1577621-1
TERMINAL RT PIDG PEEK STRATO 24-22 AWG



TE Part #1577620-1
[TERMINAL RT PIDG PEEK STRATO 24-22 AWG](#)

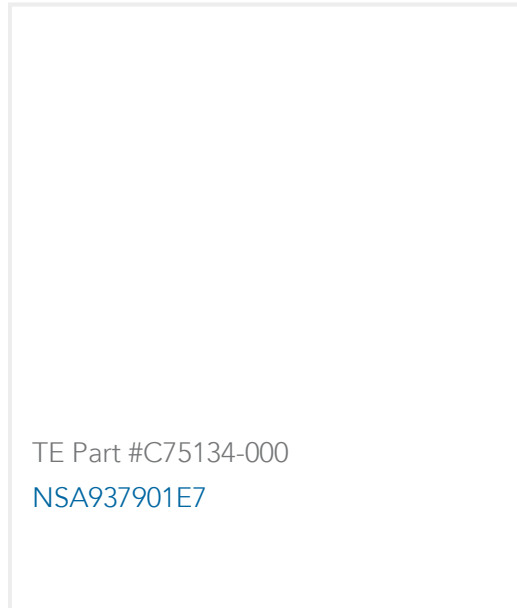

TE Part #C75134-000
[NSA937901E7](#)

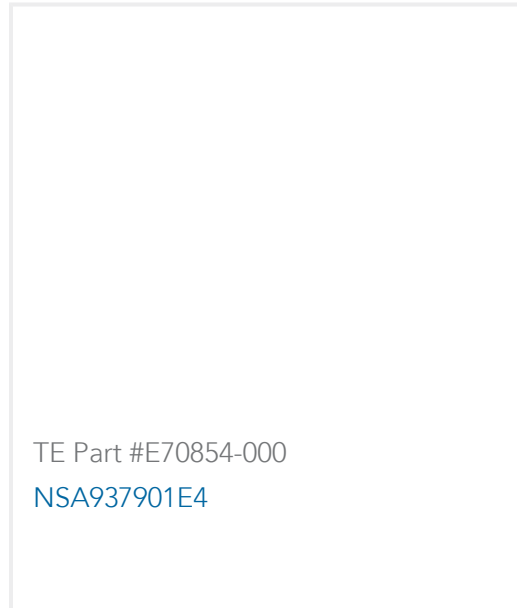

TE Part #E70854-000
[NSA937901E4](#)

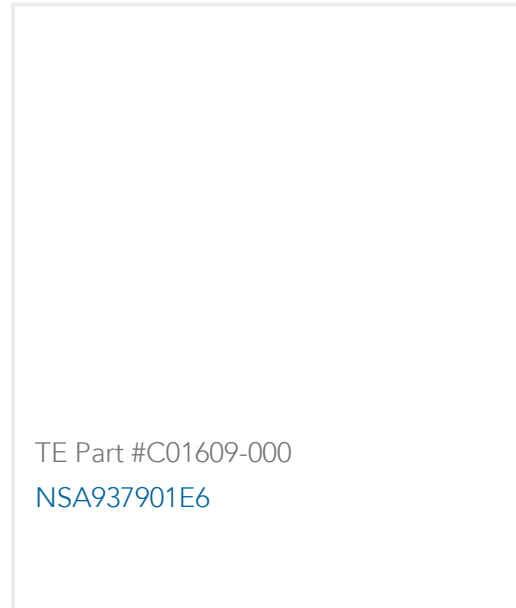

TE Part #C01609-000
[NSA937901E6](#)

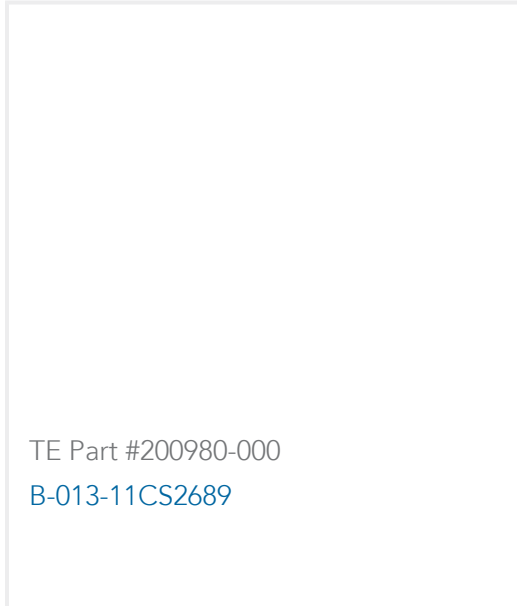

TE Part #200980-000
[B-013-11CS2689](#)

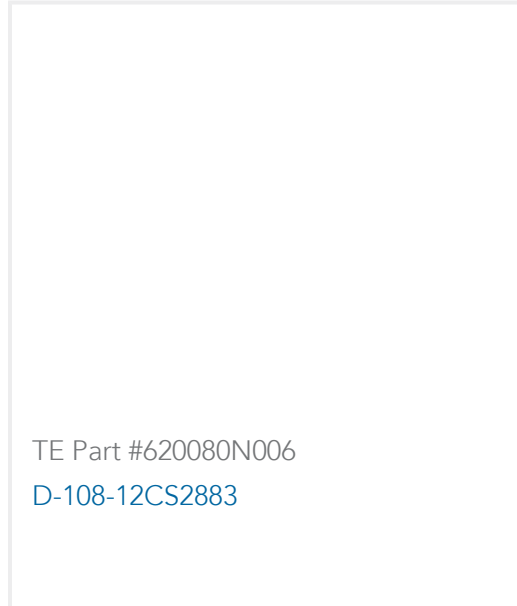

TE Part #620080N006
[D-108-12CS2883](#)

Documents

Product Drawings

[TERMINAL RT PIDG PEEK STRATO 18-16 AWG](#)

English

CAD Files

[3D PDF](#)

3D

Customer View Model

[ENG_CVM_CVM_1577633-1_B.2d_dxf.zip](#)

English

Customer View Model

[ENG_CVM_CVM_1577633-1_B.3d_igs.zip](#)

English

Customer View Model

[ENG_CVM_CVM_1577633-1_B.3d_stp.zip](#)

English

By downloading the CAD file I accept and agree to the [Terms and Conditions](#) of use.

Product Specifications

[Application Specification](#)

English