

140597 ✓ ACTIVE

FASTON | FASTON 250

TE Internal #: 140597

Tab, 6.35 mm [.25 in] Tab Width, 4.1 mm [.16 in] PCB Hole, Through Hole - Screw, Unplated Plating, Box, FASTON 250, PCB Terminals

[View on TE.com >](#)



Terminals & Splices > PCB Terminals

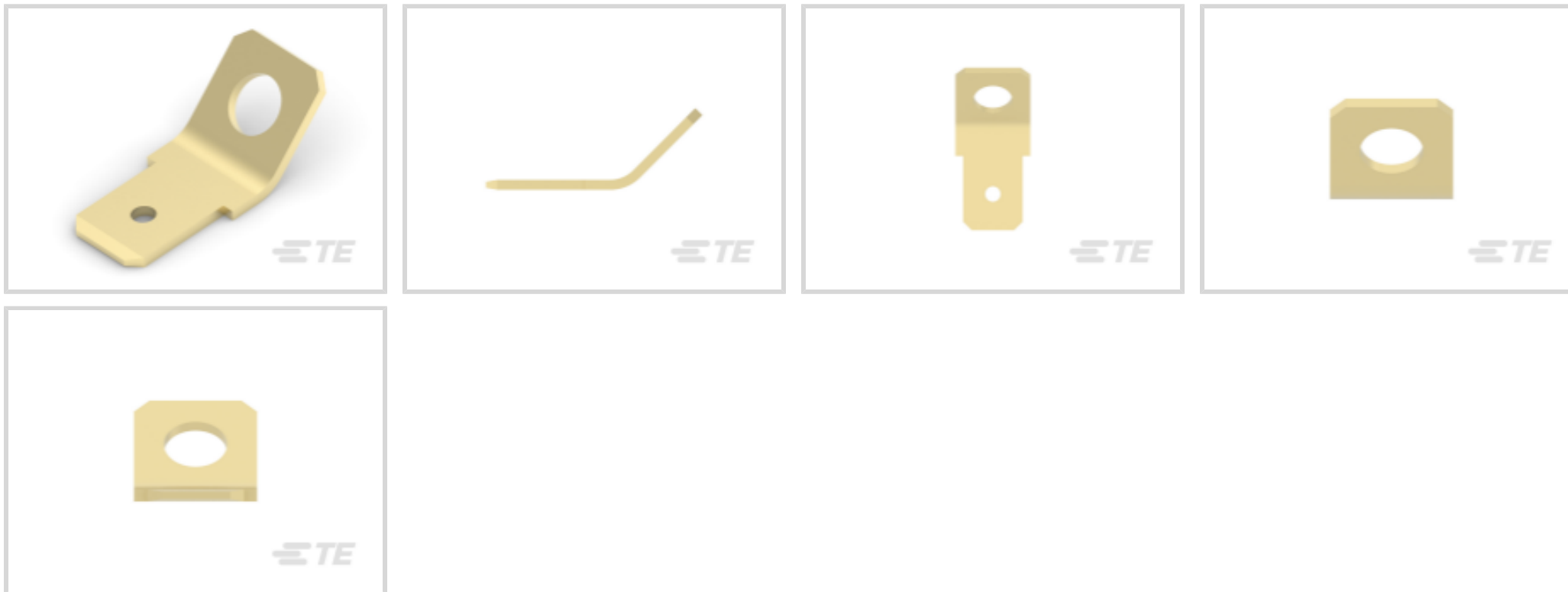

PCB Terminal Type: **Tab**

Mating Tab Width: **6.35 mm [.25 in]**

Mating Tab Thickness: **.81 mm [.032 in]**

PCB Hole Diameter: **4.1 mm [.16 in]**

Termination Method to PCB: **Through Hole - Screw**

Features

Product Type Features

Terminal Features	Stud Hole
-------------------	-----------

Usage Conditions

Insulation Option	Uninsulated
Operating Temperature Range	-30 – 110 °C[-22 – 230 °F]

Packaging Features

Packaging Quantity	500
Packaging Method	Box

Dimensions

Stud Diameter	4.09 mm[.161 in]
PCB Hole Diameter	4.1 mm[.16 in]

Contact Features

PCB Terminal Type	Tab
Mating Tab Width	6.35 mm[.25 in]
Mating Tab Thickness	.81 mm[.032 in]



Terminal Plating Material	Unplated
Contact Underplating Material	Brass
Terminal Size	6.35
Terminal Orientation	45 Bend

Termination Features

Termination Method to PCB	Through Hole - Screw
Product Terminates To	Printed Circuit Board

Other

EU RoHS Compliance	Compliant
EU ELV Compliance	Compliant

Product Compliance

[For compliance documentation, visit the product page on TE.com>](#)

EU RoHS Directive 2011/65/EU	Compliant
EU ELV Directive 2000/53/EC	Compliant
China RoHS 2 Directive MIIT Order No 32, 2016	No Restricted Materials Above Threshold
EU REACH Regulation (EC) No. 1907/2006	Current ECHA Candidate List: JUNE 2024 (241) Candidate List Declared Against: JUNE 2024 (241) Does not contain REACH SVHC
Halogen Content	Low Halogen - Br, Cl, F, I < 900 ppm per homogenous material. Also BFR/CFR/PVC Free
Solder Process Capability	Not applicable for solder process capability

Product Compliance Disclaimer

This information is provided based on reasonable inquiry of our suppliers and represents our current actual knowledge based on the information they provided. This information is subject to change. The part numbers that TE has identified as EU RoHS compliant have a maximum concentration of 0.1% by weight in homogenous materials for lead, hexavalent chromium, mercury, PBB, PBDE, DBP, BBP, DEHP, DIBP, and 0.01% for cadmium, or qualify for an exemption to these limits as defined in the Annexes of Directive 2011/65/EU (RoHS2). Finished electrical and electronic equipment products will be CE marked as required by Directive 2011/65/EU. Components may not be CE marked. Additionally, the part numbers that TE has identified as EU ELV compliant have a maximum concentration of 0.1% by weight in homogenous materials for lead, hexavalent chromium, and mercury, and 0.01% for cadmium, or qualify for an exemption to these limits as defined in the Annexes of Directive 2000/53/EC (ELV). Regarding the REACH Regulation, the information TE provides on SVHC in articles for this part number is based on the latest European Chemicals Agency (ECHA) 'Guidance on requirements for substances in articles' posted at this URL: <https://echa.europa.eu/guidance-documents/guidance-on-reach>

Compatible Parts



Also in the Series | **FASTON 250**

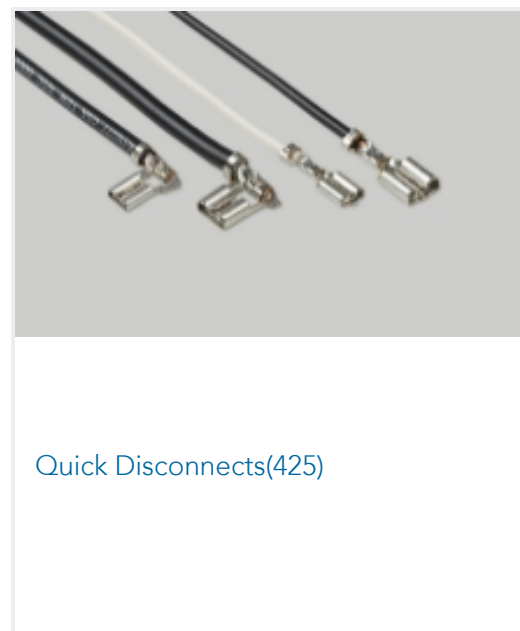
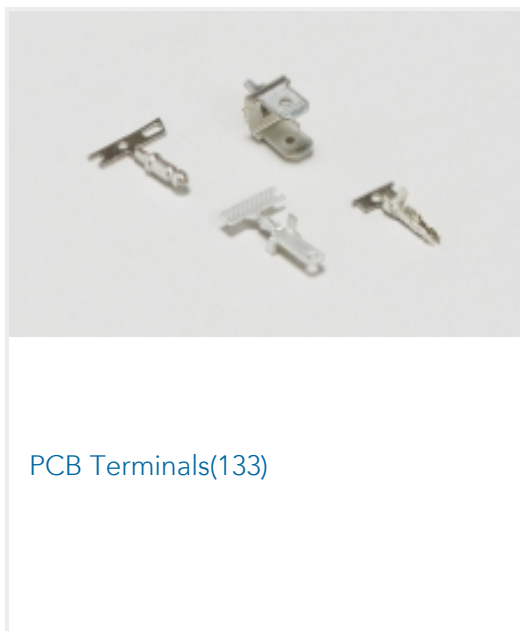
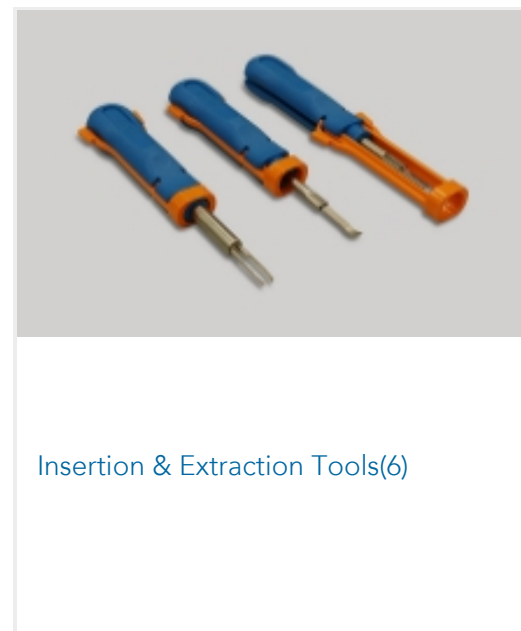
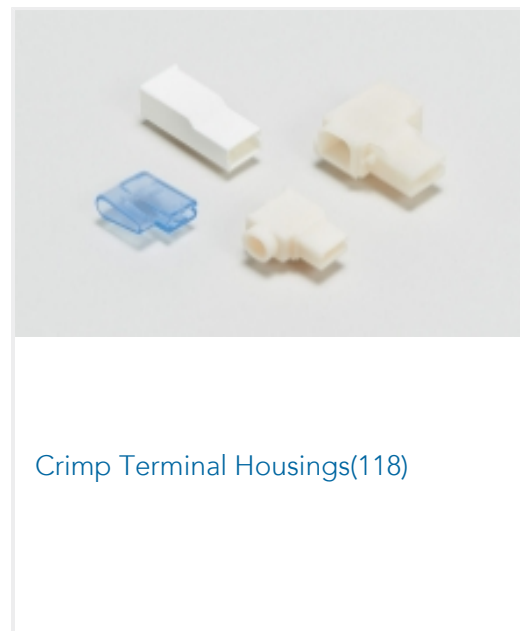
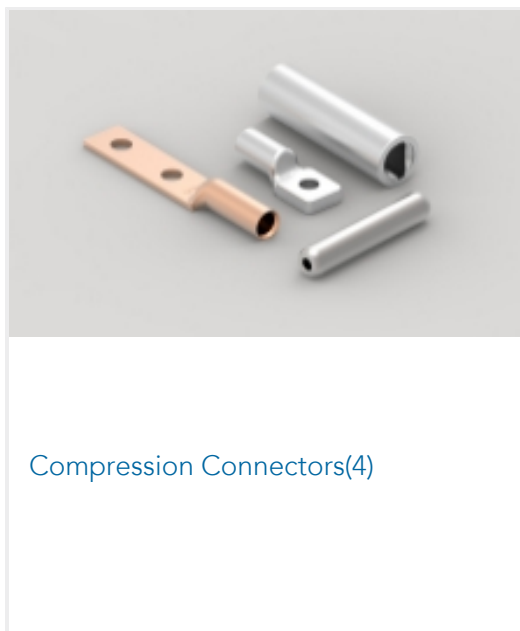

Customers Also Bought

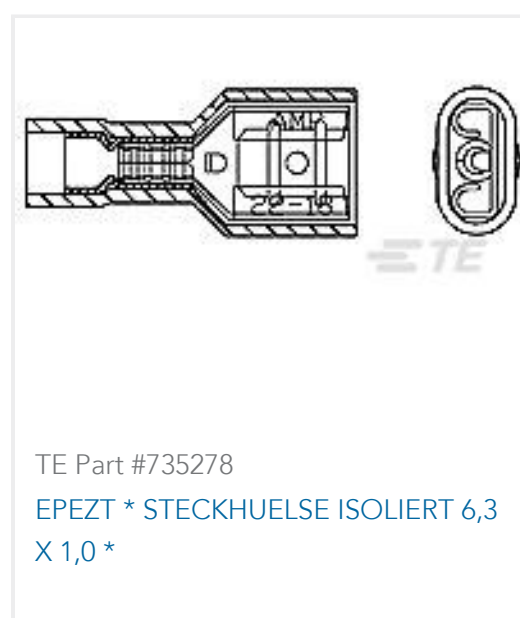



Documents

CAD Files

Customer View Model

[ENG_CVM_CVM_140597_S.2d_dxf.zip](#)

English

3D PDF

3D

Customer View Model

[ENG_CVM_CVM_140597_S.3d_igs.zip](#)

English

Customer View Model

[ENG_CVM_CVM_140597_S.3d_stp.zip](#)

English

By downloading the CAD file I accept and agree to the [Terms and Conditions](#) of use.

Agency Approvals

Agency Approval Document

English